

Silicon Power Rectifier S/R35PF Series

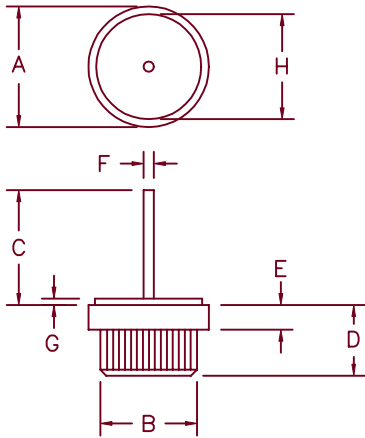

Standard Polarity:
Case is Cathode
Reverse Polarity:
Case is Anode

Dim.	Inches		Millimeter		Notes
	Minimum	Maximum	Minimum	Maximum	
A	.590	.630	15.0	16.0	Dia.
B	.499	.510	12.6	13.0	Dia.
C	.600	—	15.2	—	
D	.350	.370	8.90	9.40	
E	.090	.130	2.28	3.30	
F	.045	.053	1.14	1.35	Dia.
G	.030	.035	.762	.900	
H	.500	.510	12.7	13.0	Dia.

D0-21 (D0-208)

Microsemi Catalog Number	JEDEC Number	Repetitive Peak Reverse Voltage
S3520PF	1N3491, 1N3659	50V
	1N3492, 1N3660	100V
S3540PF	1N3493, 1N3661	200V
	1N3494, 1N3662	300V
S3560PF	1N3495, 1N3663	400V
	1N3664	500V
	1N3665	600V

For Reverse Polarity change the "S" prefix of Microsemi part number to "R". Add "R" suffix to the JEDEC part number to specify reverse polarity.

- High Voltage, Low Leakage Current
- Glass Passivated Die
- Soft Recovery
- 400 Amps Surge Rating
- V_{RRM} to 600V

Electrical Characteristics

Average Forward Current (standard polarity)	$I_F(AV)$ 35 Amps	$T_C = 133^\circ C$, half sine wave, $R_{\theta JC} = 1.0^\circ C/W$
Average Forward Current (reverse polarity)	$I_F(AV)$ 35 Amps	$T_C = 92^\circ C$, half sine wave, $R_{\theta JC} = 2.0^\circ C/W$
Maximum Surge Current	I_{FSM} 400 Amps	8.3ms, half sine, $T_J = 175^\circ C$
Maximum I^2t For Fusing	I^2t 665 A^2s	
Max. Peak Forward Voltage	V_{FM} 1.1 Volts	$I_{FM} = 35A; T_J = 25^\circ C^*$
Max. Peak Reverse Current	I_{RM} 10 μA	$V_{RRM}, T_J = 25^\circ C$
Max. Peak Reverse Current	I_{RM} 2.0 mA	$V_{RRM}, T_J = 150^\circ C$
Max. Recommended Operating Frequency	10kHz	

*Pulse test: Pulse width 300 μsec . Duty cycle 2%

Thermal and Mechanical Characteristics

Storage temp range	T_{STG}	$-65^\circ C$ to $175^\circ C$
Operating junction temp range	T_J	$-65^\circ C$ to $175^\circ C$
Max thermal resistance (standard polarity)	$R_{\theta JC}$	$1.0^\circ C/W$ Junction to case
Max thermal resistance (reverse polarity)	$R_{\theta JC}$	$2.0^\circ C/W$ Junction to case
Typical thermal resistance	$R_{\theta CS}$	$0.2^\circ C/W$ Case to sink
Typical Weight		0.3 ounce (9.0 grams) typical

11-29-00 Rev. 1

S/R35PF

Figure 1
Typical Forward Characteristics

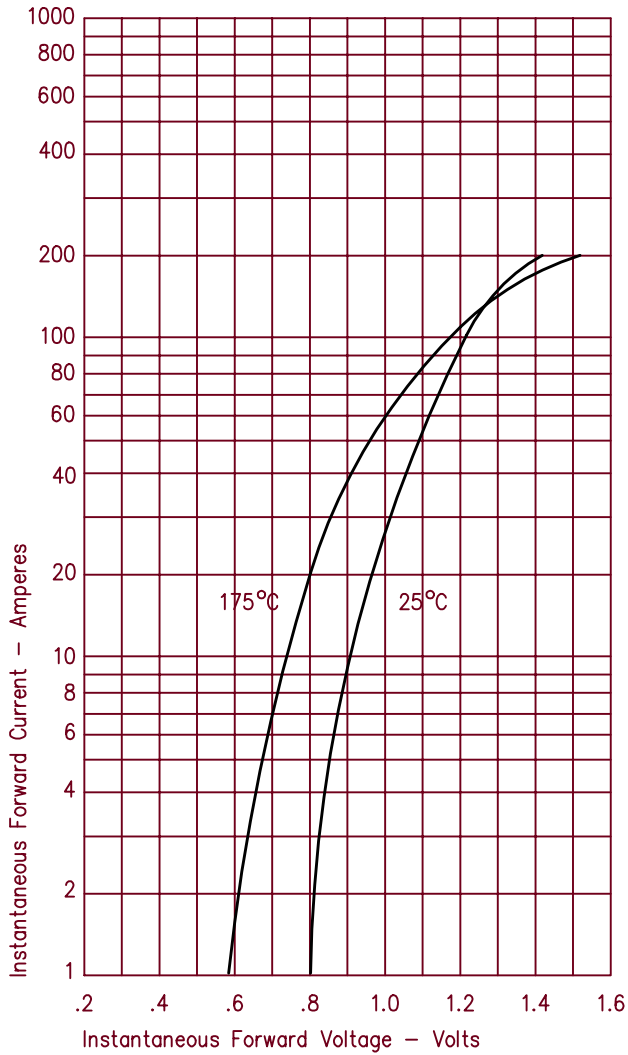

Figure 3
Forward Current Derating - Standard Polarity

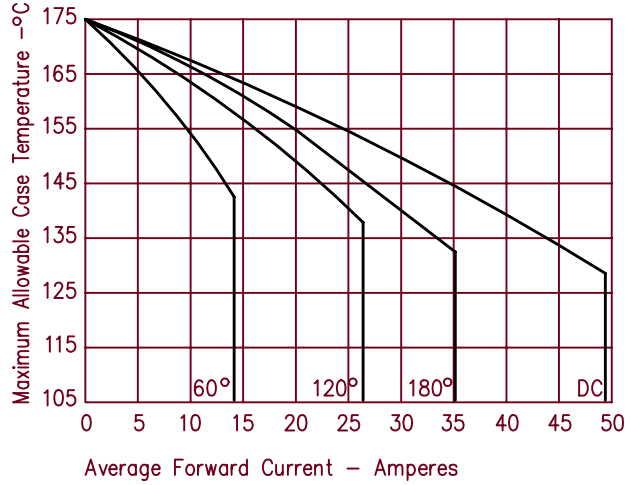

Figure 4
Maximum Forward Power Dissipation - Standard Polarity

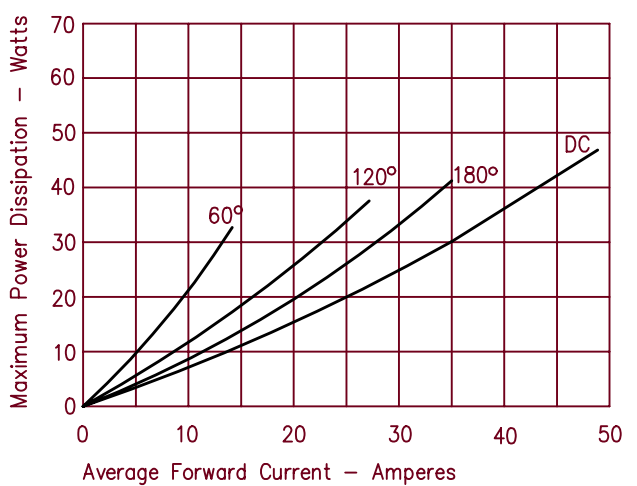

Figure 2
Typical Reverse Characteristics

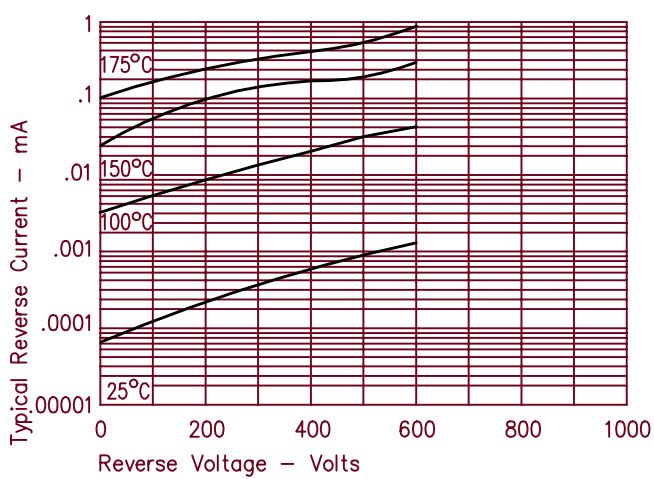
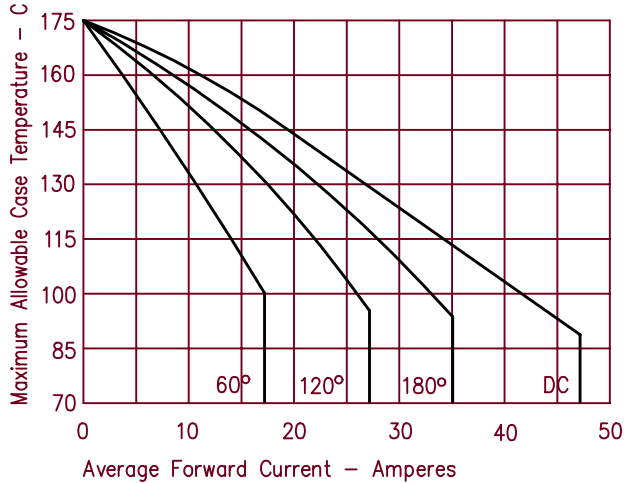

Figure 5
Forward Current Derating - Reverse Polarity



S/R35PF

Figure 6
Maximum Forward Power Dissipation – Reverse Polarity

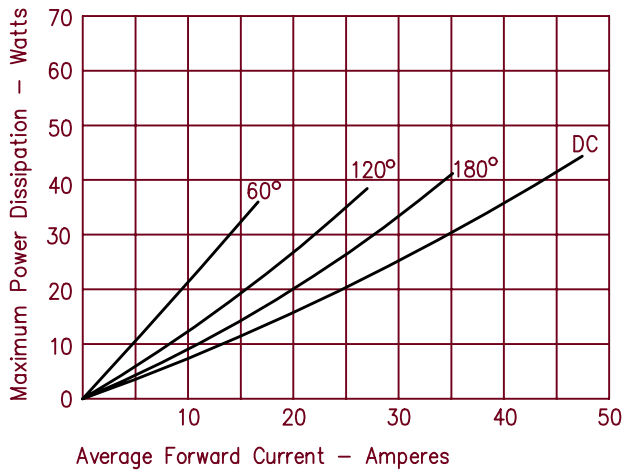

Figure 8
Transient Thermal Impedance – Reverse Polarity

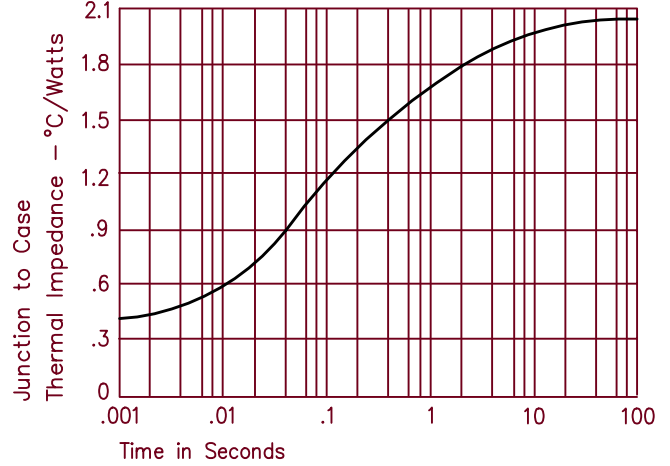

Figure 7
Transient Thermal Impedance – Standard Polarity

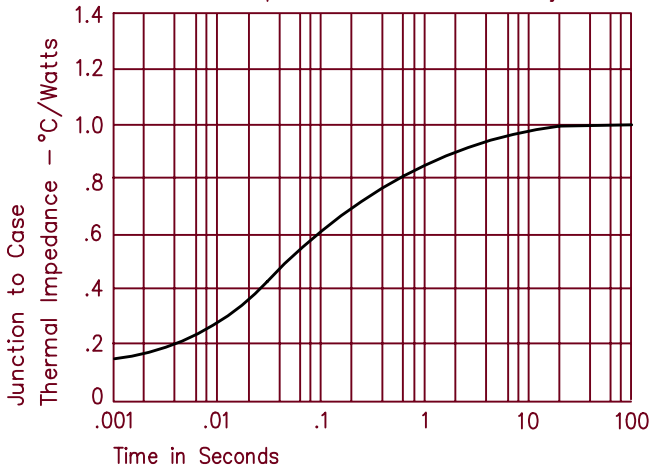
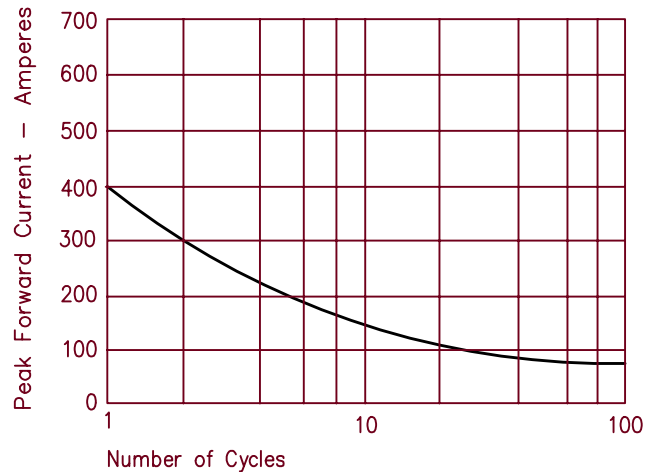
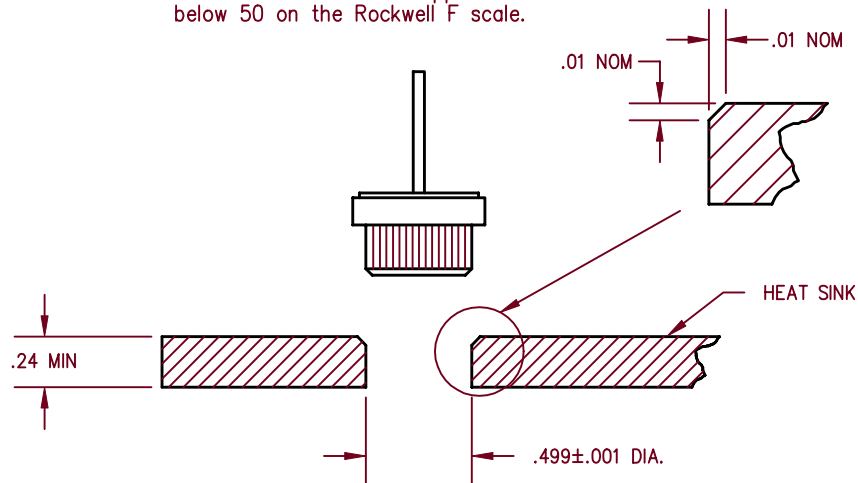

Figure 9
Maximum Nonrepetitive Surge Current



HEAT SINK MOUNTING

The hole edge must be chamfered as shown to avoid shearing off the knurl during press-in. Apply press-in force evenly to avoid tilting. Thermal compound is recommend. Recommended heat sink materials are aluminum with a hardness below 65 on Brinell scale or copper with a hardness below 50 on the Rockwell F scale.



This datasheet has been download from:

www.datasheetcatalog.com

Datasheets for electronics components.