



# 5STP 12F4201

Old part no. TV 918-1200-42

## Phase Control Thyristor

### Properties

- High operational capability
- Possibility of serial and parallel connection

### Applications

- Controlled rectifiers
- AC drives

### Key Parameters

$V_{DRM}, V_{RRM}$	= 4 200	V
$I_{TAVm}$	= 1 247	A
$I_{TSM}$	= 15 000	A
$V_{TO}$	= 1.252	V
$r_T$	= 0.421	mΩ

### Types

	$V_{RRM}, V_{DRM}$
<b>5STP 12F4201</b>	<b>4 200 V</b>
Conditions:	$T_j = -40 \div 125 \text{ }^\circ\text{C}$ , half sine waveform, $f = 50 \text{ Hz}$ , note 1

### Mechanical Data

$F_m$	Mounting force	22 ± 2 kN
$m$	Weight	0.48 kg
$D_s$	Surface creepage distance	25 mm
$D_a$	Air strike distance	13 mm

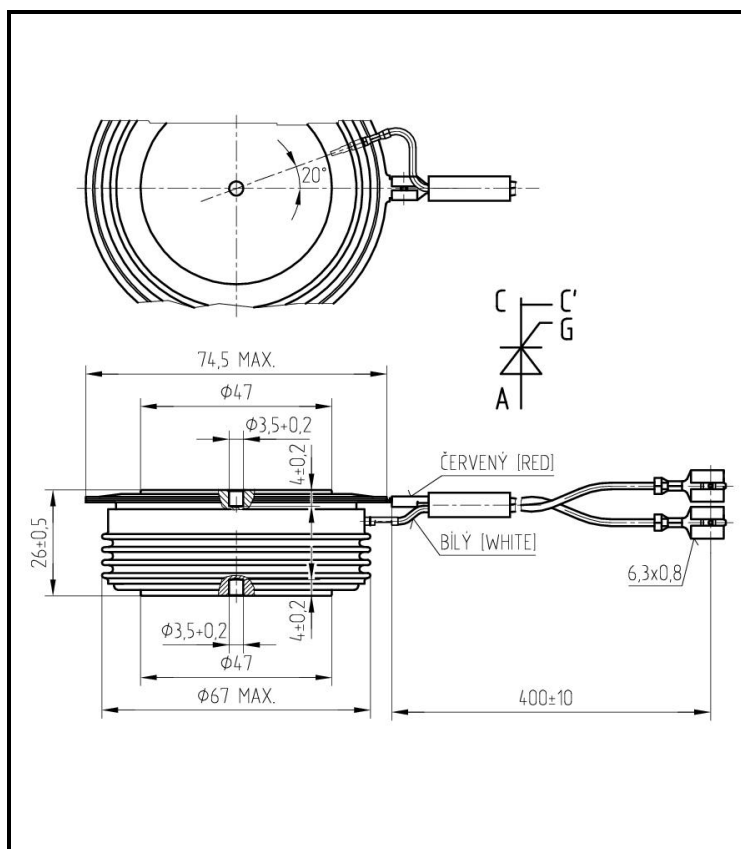

Fig. 1 Case



ABB s.r.o.

Novodvorska 1768/138a, 142 21 Praha 4, Czech Republic

tel.: +420 261 306 250, <http://www.abb.com/semiconductors>

<b>Maximum Ratings</b>		<b>Maximum Limits</b>	<b>Unit</b>
$V_{RRM}$ $V_{DRM}$	<b>Repetitive peak reverse and off-state voltage</b> $T_j = -40 \div 125 \text{ }^\circ\text{C}$ , note 1	<b>4 200</b>	<b>V</b>
$V_{RSM}$ $V_{DSM}$	<b>Non-repetitive peak reverse and off-state voltage</b> $T_j = 25 \div 125 \text{ }^\circ\text{C}$	<b>4 300</b>	<b>V</b>
$I_{TRMS}$	<b>RMS on-state current</b> $T_c = 70 \text{ }^\circ\text{C}$ , half sine waveform, $f = 50 \text{ Hz}$	<b>1 959</b>	<b>A</b>
$I_{TAVm}$	<b>Average on-state current</b> $T_c = 70 \text{ }^\circ\text{C}$ , half sine waveform, $f = 50 \text{ Hz}$	<b>1 247</b>	<b>A</b>
$I_{TSM}$	<b>Peak non-repetitive surge</b> half sine pulse, $V_R = 0 \text{ V}$	$t_p = 10 \text{ ms}$ <b>15 000</b> $t_p = 8.3 \text{ ms}$ <b>16 000</b>	<b>A</b>
$I^2t$	<b>Limiting load integral</b> half sine pulse, $V_R = 0 \text{ V}$	$t_p = 10 \text{ ms}$ <b>1 125 000</b> $t_p = 8.3 \text{ ms}$ <b>1 060 000</b>	<b>A<sup>2</sup>s</b>
$(di_T/dt)_{cr}$	<b>Critical rate of rise of on-state current</b> $I_T = I_{TAVm}$ , half sine waveform, $f = 50 \text{ Hz}$ , $V_D = 2/3 V_{DRM}$ , $t_r = 0.3 \text{ } \mu\text{s}$ , $I_{GT} = 2 \text{ A}$	<b>150</b>	<b>A/<math>\mu\text{s}</math></b>
$(dv_D/dt)_{cr}$	<b>Critical rate of rise of off-state voltage</b> $V_D = 2/3 V_{DRM}$	<b>1 000</b>	<b>V/<math>\mu\text{s}</math></b>
$P_{GAVm}$	<b>Maximum average gate power losses</b>	<b>3</b>	<b>W</b>
$I_{FGM}$	<b>Peak gate current</b>	<b>10</b>	<b>A</b>
$V_{FGM}$	<b>Peak gate voltage</b>	<b>12</b>	<b>V</b>
$V_{RGM}$	<b>Reverse peak gate voltage</b>	<b>10</b>	<b>V</b>
$T_{jmin} - T_{jmax}$	<b>Operating temperature range</b>	<b>-40 <math>\div</math> 125</b>	<b><math>^\circ\text{C}</math></b>
$T_{stgmin} - T_{stgmax}$	<b>Storage temperature range</b>	<b>-40 <math>\div</math> 125</b>	<b><math>^\circ\text{C}</math></b>

Unless otherwise specified  $T_j = 125 \text{ }^\circ\text{C}$

Note 1: De-rating factor of 0.13%  $V_{RRM}$  or  $V_{DRM}$  per  $^\circ\text{C}$  is applicable for  $T_j$  below  $25 \text{ }^\circ\text{C}$

Characteristics		Value			Unit
		min.	typ.	max.	
$V_{TM}$	<b>Maximum peak on-state voltage</b> $I_{TM} = 2\ 000\ A$			2.100	V
$V_{T0}$	<b>Threshold voltage</b>			1.252	V
$r_T$	<b>Slope resistance</b> $I_{T1} = 1\ 885\ A, I_{T2} = 5\ 655\ A$			0.421	m $\Omega$
$I_{DM}$	<b>Peak off-state current</b> $V_D = V_{DRM}$			150	mA
$I_{RM}$	<b>Peak reverse current</b> $V_R = V_{RRM}$			150	mA
$t_{gd}$	<b>Delay time</b> $T_j = 25\ ^\circ C, V_D = 0.4\ V_{DRM}, I_{TM} = I_{TAVm},$ $t_r = 0.3\ \mu s, I_{GT} = 2\ A$			3	$\mu s$
$t_q$	<b>Turn-off time</b> $I_T = 2\ 000\ A, di_T/dt = 12.5\ A/\mu s,$ $V_D = 2/3\ V_{DRM}, dv_D/dt = 50\ V/\mu s$		600		$\mu s$
$Q_{rr}$	<b>Recovery charge</b> the same conditions as at $t_q$		2 500		$\mu C$
$I_H$	<b>Holding current</b>	$T_j = 25\ ^\circ C$ $T_j = 125\ ^\circ C$	170 90		mA
$I_L$	<b>Latching current</b>	$T_j = 25\ ^\circ C$ $T_j = 125\ ^\circ C$	450 350		mA
$V_{GT}$	<b>Gate trigger voltage</b> $V_D = 12\ V, I_T = 4\ A$	$T_j = -40\ ^\circ C$ $T_j = 25\ ^\circ C$ $T_j = 125\ ^\circ C$	0.25	4 3 2	V
$I_{GT}$	<b>Gate trigger current</b> $V_D = 12\ V, I_T = 4\ A$	$T_j = -40\ ^\circ C$ $T_j = 25\ ^\circ C$ $T_j = 125\ ^\circ C$	10	500 300 200	mA

Unless otherwise specified  $T_j = 125\ ^\circ C$

Thermal Parameters		Value	Unit
$R_{thjc}$	<b>Thermal resistance junction to case</b> double side cooling	16.0	K/kW
	anode side cooling	25.0	
	cathode side cooling	45.0	
$R_{thch}$	<b>Thermal resistance case to heatsink</b> double side cooling	4.0	K/kW
	single side cooling	8.0	

ABB s.r.o., Novodvorska 1768/138a, 142 21 Praha 4, Czech Republic

**Transient Thermal Impedance**

Analytical function for transient thermal impedance

$$Z_{thjc} = \sum_{i=1}^4 R_i (1 - \exp(-t / \tau_i))$$

Conditions:

$F_m = 22 \pm 2$  kN, Double side cooled

**Correction for periodic waveforms**

- 180° sine: add 1.3 K/kW
- 180° rectangular: add 1.8 K/kW
- 120° rectangular: add 3.0 K/kW
- 60° rectangular: add 5.1 K/kW

<i>i</i>	1	2	3	4
$\tau_i$ (s)	0.4653	0.1533	0.0375	0.0034
$R_i$ (K/kW)	5.50	7.24	2.00	1.34

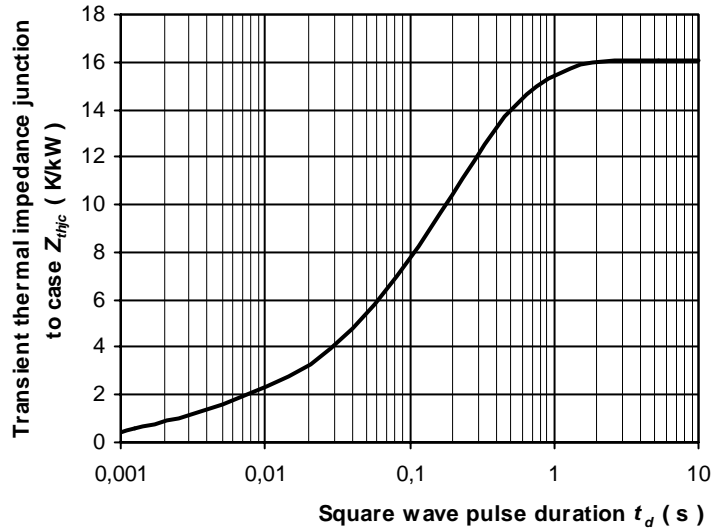

Fig. 2 Dependence transient thermal impedance junction to case on square pulse

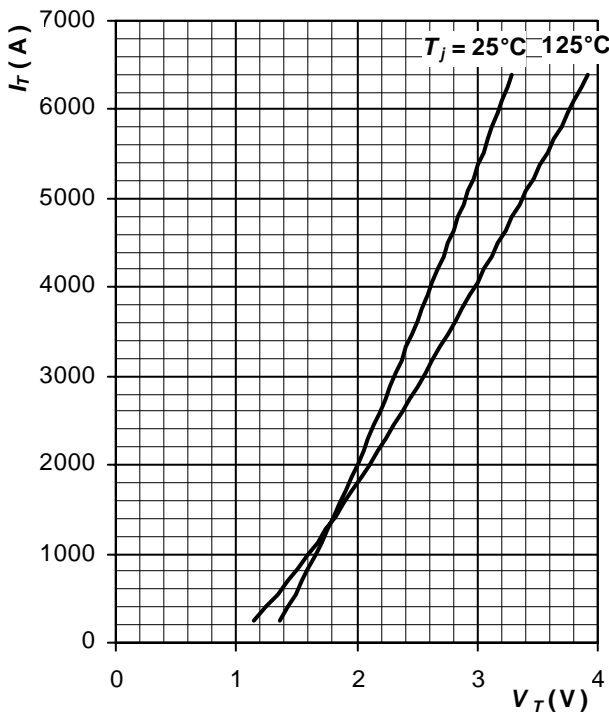

Fig. 3 Maximum on-state characteristics

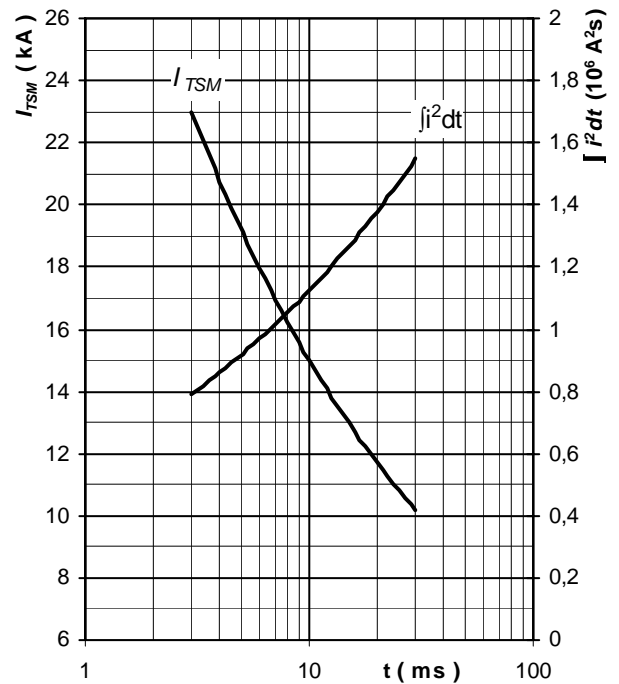

Fig. 4 Surge on-state current vs. pulse length, half sine wave, single pulse,  $V_R = 0$  V,  $T_j = T_{jmax}$

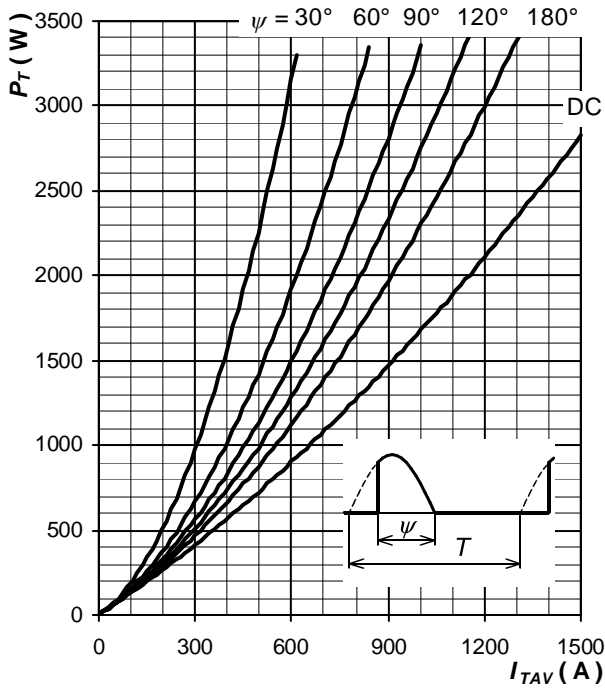

Fig. 5 On-state power loss vs. average on-state current, sine waveform,  $f = 50 \text{ Hz}$ ,  $T = 1/f$

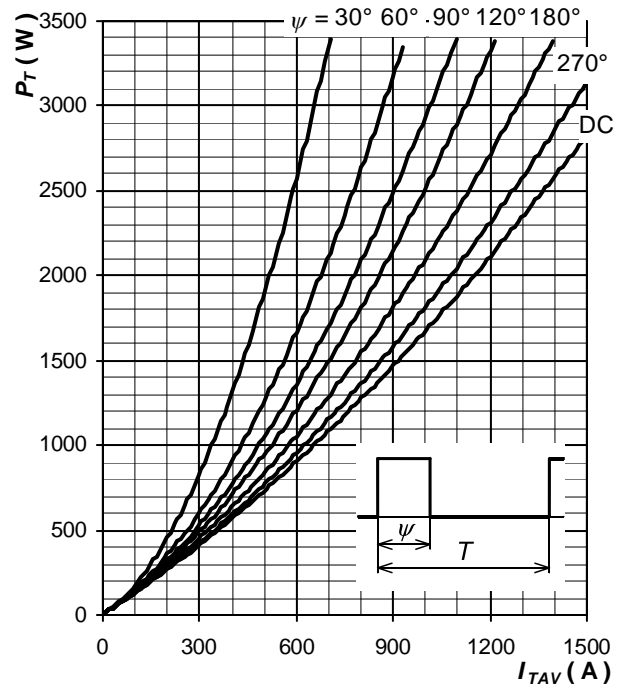

Fig. 6 On-state power loss vs. average on-state current, square waveform,  $f = 50 \text{ Hz}$ ,  $T = 1/f$

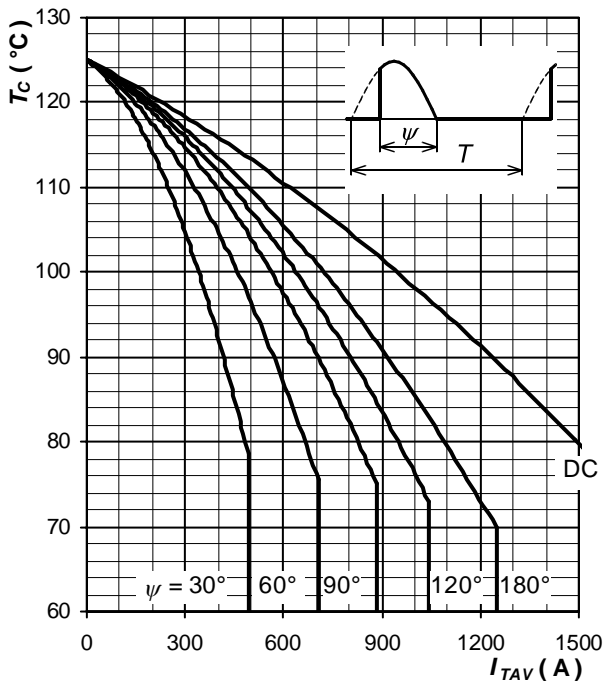

Fig. 7 Max. case temperature vs. aver. on-state current, sine waveform,  $f = 50 \text{ Hz}$ ,  $T = 1/f$

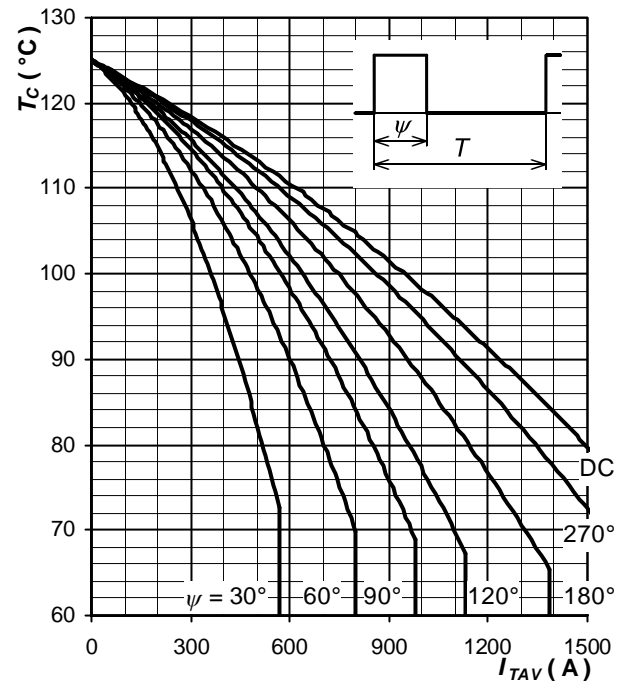

Fig. 8 Max. case temperature vs. aver. on-state current, square waveform,  $f = 50 \text{ Hz}$ ,  $T = 1/f$

Notes: