



182

RECTIFIERS 750 TO 1500 AMPERES



183

GE TYPE	A437	A596	A430	A540	A696	A570	A640
JEDEC	-	-	-	-	-	-	-
SPECIFICATIONS							
$I_{FM(AV)}$ Max. average forward current (1 phase operation) (A) @ $T_C = (^\circ C)$	750 85	750 65	1000 125	1000 100	1000 -	1500 80	1500 90
$V_{FM(rep)}$ Max. repetitive peak reverse voltage (V)							
100	A437A	-	A430A	-	-	A570A	-
200	A437B	-	A430B	-	-	A570B	-
300	A437C	-	A430C	-	-	A570C	-
400	A437D	-	A430D	-	-	A570D	-
500	A437E	-	A430E	-	-	A570E	-
600	A437M	-	A430M	-	-	A570M	-
700	A437S	-	A430S	-	-	-	-
800	A437N	A596N	A430N	-	-	-	-
900	A437T	A596T	A430T	-	-	-	-
1000	A437P	A596P	A430P	-	-	-	A640P
1100	A437PA	A596PA	A430PA	-	-	-	A640PA
1200	A437PB	A596PB	A430PB	-	-	-	A640PB
1300	A437PC	A596PC	A430PC	-	-	-	A640PC
1400	A437PD	A596PD	A430PD	-	-	-	A640PD
1500	A437PE	-	A430PE	-	A696PE	-	A640PE
1600	-	-	-	-	A696PM	-	A640PM
1700	-	-	-	-	A696PS	-	A640PS
1800	-	-	-	-	A696PM	-	A640PM
1900	-	-	-	-	A696PT	-	A640PT
2000	-	-	-	A540L	A696L	-	A640L
2100	-	-	-	A540LA	-	-	-
2200	-	-	-	A540LB	-	-	-
2300	-	-	-	A540LC	-	-	-
2400	-	-	-	A540LD	-	-	-
2500	-	-	-	-	-	-	-
2600	-	-	-	-	-	-	-
2700	-	-	-	-	-	-	-
2800	-	-	-	-	-	-	-
2900	-	-	-	-	-	-	-
3000	-	-	-	-	-	-	-
I_{FM} (surge) Max. peak one cycle, non-recurrent surge current (60 Hz sine wave, 1 phase operation) @ max. rated load conditions (A)	10,000	10,000	10,000	12,000	14,000	18,000	15,000
I^2t Max. non-repetitive for 8.3 msec (A^2 sec)	415,000	415,000	415,000	597,000	-	1,300,000	1,062,000
T_J Operating junction temperature range ($^\circ C$)	-40 to +175	-40 to +175	-40 to +200	-40 to +200	-40 to +150	-40 to +200	-40 to +200
T_{stg} Storage temperature range ($^\circ C$)	-40 to +200	-40 to +200	-40 to +200	-40 to +200	-40 to +150	-40 to +200	-40 to +200
$R_{\theta JC}$ Max. thermal resistance, junction-to-case ($^\circ C/W$)	.057	.057	.06	.057	.036	.057	.045
V_{FM} Max. peak forward voltage drop @ rated $I_{F(AV)}$ (1 phase operation) @ $T_C = (^\circ C)$	2.0 25	2.3 125	1.55 25	1.15 150	-	1.0 25	1.0 25
Q_{rr} Max. reverse recovered charge @ $T_J = 25^\circ C$	100	300	-	-	500	-	-
PACKAGE NO.	183	182	183	182	183	182	183

High Speed Fast Recovery Rectifier

A596

750A Avg., Up to 1400 Volts

The A596 high power rectifier diode is designed for use in high frequency applications – or wherever a fast/soft recovery performance is required. The A596 is rated to 5 KHz.

FEATURES:

- Reverse Blocking Voltage to 1200 Volts
- Soft Recovery With Low Recovered Charge
- Pressure Contacts
- Diffused Construction
- Glazed Ceramic Package with 1" Creepage Path
- Reversibility (eliminates need for special reverse polarity units)
- Fully Characterized to 5 KHz
- Available in Factory Assembled Heat Exchangers or Ready-to-Mount

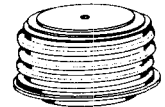

IMPORTANT: Mounting instructions on the last page of the C501 specification must be followed.

MAXIMUM ALLOWABLE RATINGS

TYPES	REPETITIVE PEAK REVERSE VOLTAGE, V_{RRM}^1 $T_J = -40^\circ\text{C to } +175^\circ\text{C}$	TRANSIENT PEAK REVERSE VOLTAGE, V_{RSM}^2 (NON-RECURRENT 5 MSEC MAX.) $T_J = -40^\circ\text{C to } +175^\circ\text{C}$	PEAK REVERSE LEAKAGE CURRENT		
			125°C	150°C	175°C
A596N	800 Volts	900 Volts	15mA	40mA	125mA
A596T	900	1000	15	40	125
A596P	1000	1100	15	40	125
A596PA	1100	1200	15	40	125
A596PB	1200	1300	15	40	125
A596PC	1300	1400	16	50	150
A596PD	1400	1500	20	60	175

Average Forward Current	750 Amperes, 1 Φ Average
Peak One-Cycle Surge Current	10,000 Amperes
Minimum I^2t Rating (for times ≥ 1.5 msec)	320,000 Ampere ² Seconds
Minimum I^2t Rating (at 8.3 msec)	415,000 Ampere ² Seconds
Maximum On-State Voltage Drop ($I_{TM} = 3500$ Amps, $T_J = 125^\circ\text{C}$)	2.3 Volts
Maximum Thermal Resistance, $R_{\theta JS}$ (1 ϕ) (Double-Side Cooling)	0.06°C/Watt
Storage Temperature, T_{STG}	-40°C to +200°C
Operating Temperature, T_J	-40°C to +175°C
Mounting Force Required	2200 Lbs. \pm 10%
	9.8 KN \pm 10%

NOTES:

- ¹ Assumes a heatsink Thermal Resistance of less than 1.1°C/watt.
- ² Non-recurrent voltage and current ratings, as contrasted to repetitive ratings which apply for occasional or unpredictable overloads. For example, the forward surge current ratings are non-recurrent ratings that are used in fault coordination work.

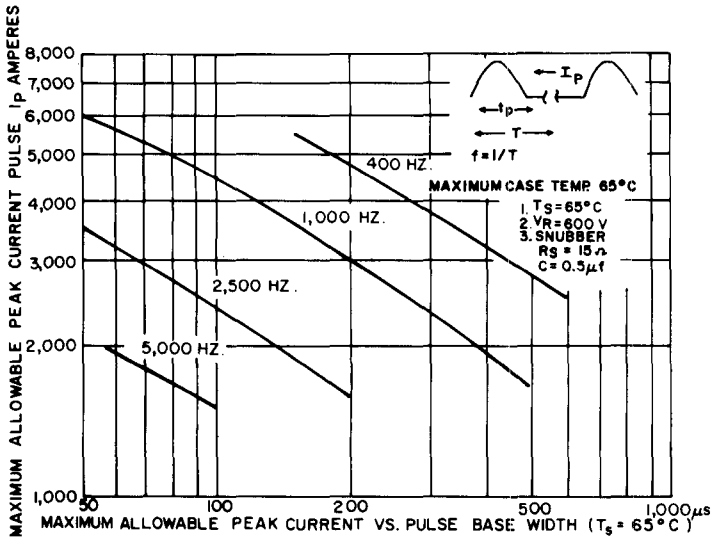

1. MAXIMUM ALLOWABLE PEAK CURRENT VERSUS PULSE BASE WIDTH ($T_s = 65^\circ\text{C}$)

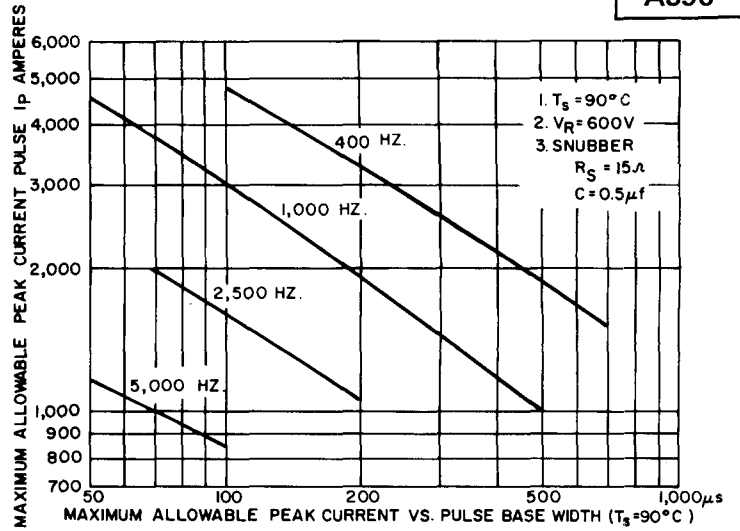

2. MAXIMUM ALLOWABLE PEAK CURRENT VERSUS PULSE BASE WIDTH ($T_s = 90^\circ\text{C}$)

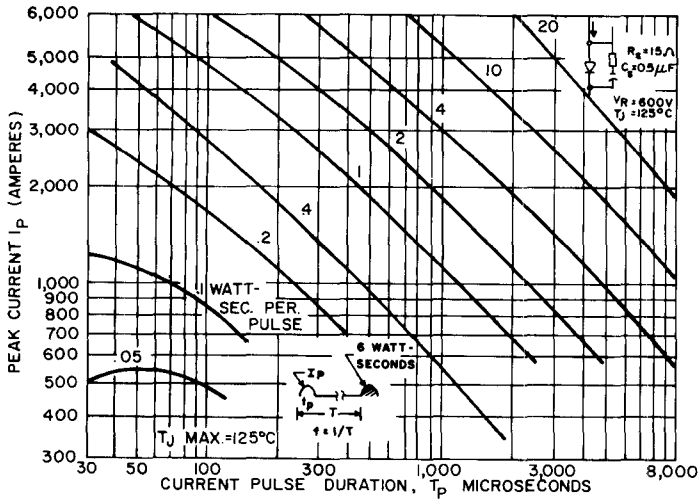

3. ENERGY PER PULSE FOR SINUSOIDAL PULSES

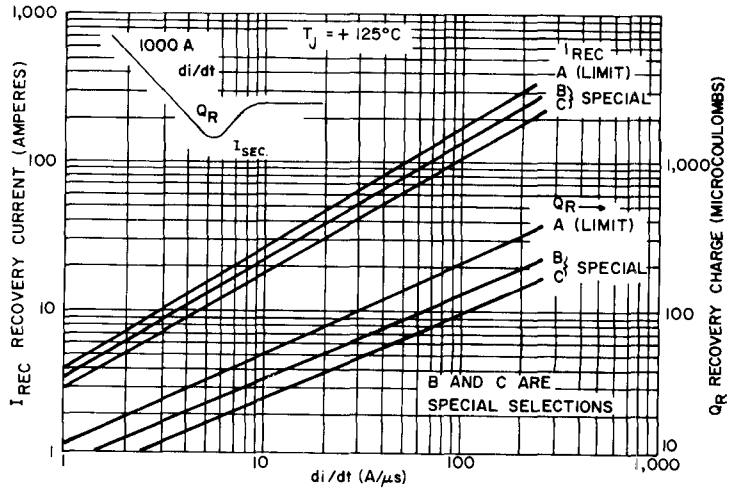

4. MAXIMUM RECOVERY CURRENT (LEFT HAND SCALE) AND MAXIMUM RECOVERY CHARGE (RIGHT HAND SCALE)

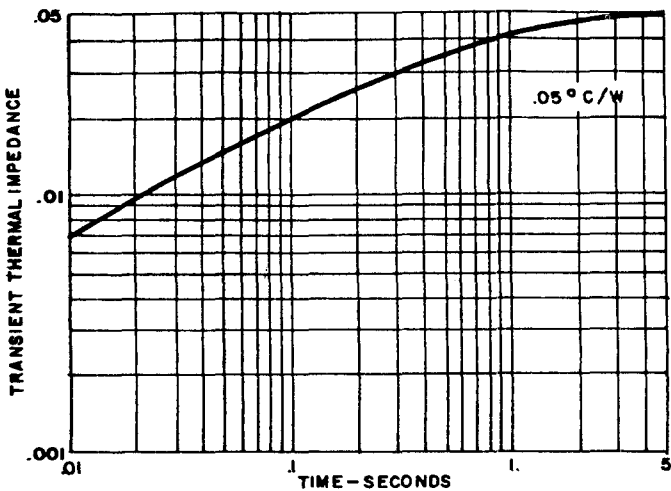

5. TRANSIENT THERMAL IMPEDANCE - JUNCTION-TO-CASE

NOTES:

1. Add $.01^\circ\text{C/W}$ to account for both case to dissipator interfaces, when properly mounted; e.g., $R_{\theta JS} = .06^\circ\text{C/W}$. See Mounting Instructions.
2. DC Thermal Impedance is based on average full cycle junction temperature. Instantaneous junction temperature may be calculated using the following modifications.
 - end of conducting portion of cycle
 - 120° sq. wave add $.0065^\circ\text{C/W}$ along entire curve
 - 180° sq. wave add $.0047^\circ\text{C/W}$ along entire curve
 - 180° sine wave add $.0026^\circ\text{C/W}$ along entire curve
 - end of full cycle
 - any wave, subtract $.0026^\circ\text{C/W}$ along entire curve

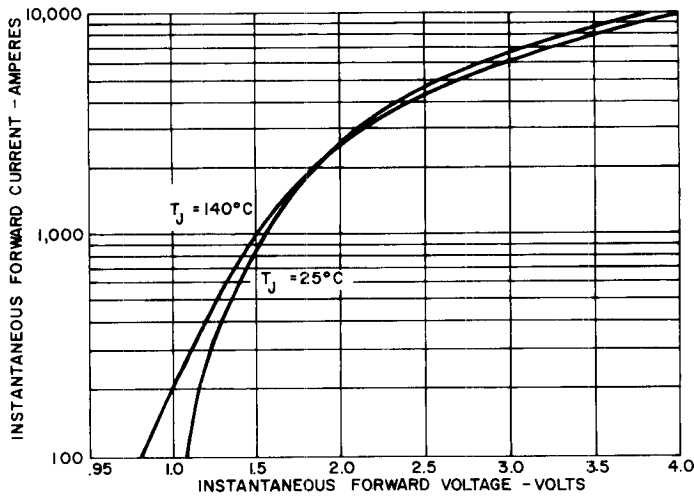

6. MAXIMUM ON-STATE CHARACTERISTICS

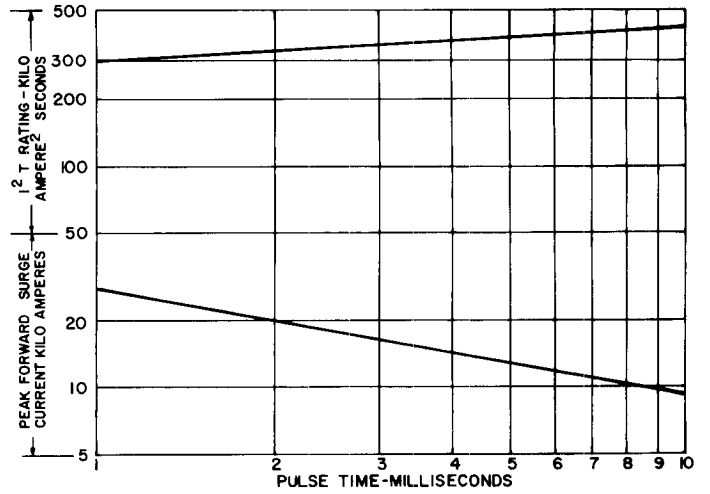

7. SUBCYCLE PEAK SURGE FORWARD CURRENT AND I^2t RATING FOLLOWING RATED LOAD CONDITIONS

OUTLINE DRAWING

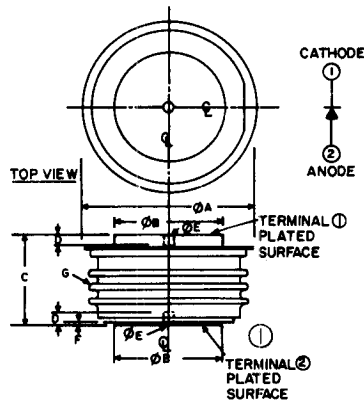

NOTE:
1. GLAZED CERAMIC INSULATOR
WITH 1.00 INCH MIN. SURFACE
CREEPAGE (25.40mm)

SYMBOL	INCHES		MILLIMETERS		NOTE
	MIN	MAX	MIN	MAX	
Ø A	—	2.000	—	50.80	
Ø B	1.240	1.260	31.50	32.00	
C	1.000	1.060	25.40	26.92	
D	.080	—	2.03	—	
Ø E	0.136	0.146	3.45	3.71	
F	.034	—	0.86	—	
G					1