

- On chip latches for the ASCII input data
- Output enable for display blanking and duty cycle dimming
- TTL compatible inputs
- 5 volt operation

N OR NF DUAL-IN-LINE PACKAGE
(TOP VIEW)

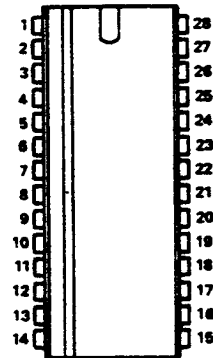

96
002943
description 2943
6R16
T1

This \overline{L} circuit is designed to drive 18-segment alphanumeric displays. The input format is a 6-bit ASCII subset. Input latches are provided for applications in which the data cannot be continuously applied. When the clock input is low, data is passed through the latches. When the clock goes high, the data present during the rising edge is latched. A logic low on the output enable pin disables all 18 output drivers.

The output drivers are NPN emitter followers that switch to $V_{CC} - 1V$ to turn on each segment. Maximum output current is 64 mA/segment, which must be limited by an external resistor for each output. This maximum current allows displays of up to 16 characters to be constructed using one display driver chip and external multiplexing circuitry.

absolute maximum ratings: at $T_A = 25^\circ C$ (unless otherwise noted)

Supply voltage, V_{CC}	7V
Input voltage: any logic input	7V
Operating free-air temperature range	$-40^\circ C$ to $85^\circ C$
Storage temperature range	$-65^\circ C$ to $150^\circ C$

Recommended operating conditions

	MIN	NOM	MAX	UNIT
Supply voltage, V_{CC}	4.5	5	5.5	V
Operating free-air temperature	-40	25	85	$^\circ C$

TEXAS INSTRUMENTS
INCORPORATED

recommended operating conditions	T_A	MIN	MAX	UNIT
Output Current per Output	0° to +70°C		-64	mA
	-40° to +85°C		-38	mA
Input Slew Rate			7	nS 10%-90%
Minimum Clock Pulse Width	0° to 70°C	300		nS
	-40° to +85°C	400		nS
Setup Time	0° to 70°C	250		nS
	-40° to +85°C	350		nS
Hold Time	0° to 70°C	50		nS
	-40° to +85°C	100		nS

ELECTRICAL CHARACTERISTICS- OVER RECOMMENDED OPERATING FREE AIR TEMPERATURE RANGE (UNLESS OTHERWISE NOTED)

PARAMETER	TEST CONDITIONS	MIN	TYP	MAX	UNITS
V_{IH} High Level Input Voltage		2			V
V_{IL} Low Level Input Voltage				.8	V
I_I Input Current at Maximum Input Voltage	$V_{IN} = 7 V$		1.26	2.1	mA
I_{IH} High Level Input Current	$V_{IN} = 2.4 V$		340	525	uA
I_{IL} Low Level Input Current	$V_{IN} = .4 V$		40	65	uA
I_{EE} Supply Current, Outputs Disabled	$V_{CC} = 5.5 V$ inputs and outputs open		1	3	mA
I_{EE} Supply Current 10 Outputs Enabled	$V_{CC} = 5.5 V$ Outputs Open Inputs 13, 17 and 18 at 3.5 V Other inputs open		28	37	mA

ADVANCED CIRCUITS

ELECTRICAL CHARACTERISTICS

PARAMETER	TEST CONDITIONS		MIN	TYP*	MAX	UNIT
V_{OL} Low Level	Output loaded with 1K ohm to ground			0	.4	V
V_{OH} High Level	$I_{OUT} = 1mA$	$V_{CC} = 4.5$	3.4	3.7	4.0	V
		$V_{CC} = 5.5V$	4.4	4.7	5.0	V
Z_{OUT} High Level Output Impedance				4	9	ohm

* All typical values at $V_{CC} = 5.0 V, T_A = 25^{\circ}C$.

SWITCHING CHARACTERISTICS, $V_{CC} = 5V, T_A = 25^{\circ}C$.

PARAMETER	TEST CONDITIONS	MIN	TYP	MAX	UNIT
Decode Delay	ASCII Input to segment driver output		7	15	μS
Enable Delay	Enable input to segment driver output		4	10	μS

Outputs are loaded with 330 ohm to ground

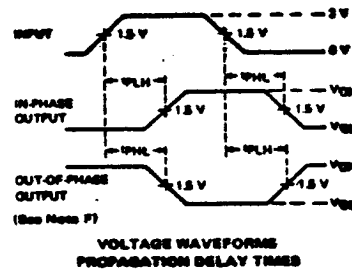
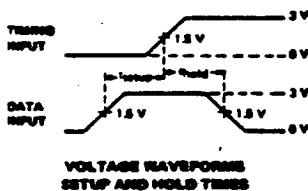

18 - SEGMENT FORMAT

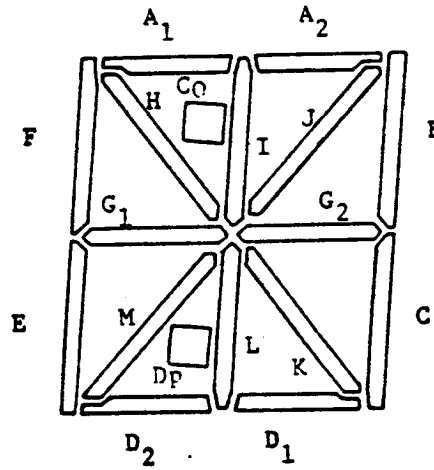

PIN DESCRIPTION

<u>PIN NO.</u>	<u>FUNC.</u>	<u>DESCRIPTION</u>	<u>PIN NO.</u>	<u>FUNC.</u>	<u>DESCRIPTION</u>
1	V _{CC}	Power Supply	15	GND	Ground
2	L	Segment Driver	16	A ₄	Decode Input
3	K	Segment Driver	17	A ₅	Decode Input
4	I	Segment Driver	18	Out En	Output Enable
5	G ₂	Segment Driver	19	A ₁	Segment Driver
6	D ₁	Segment Driver	20	F	Segment Driver
7	C	Segment Driver	21	DP	Segment Driver
8	B	Segment Driver	22	E	Segment Driver
9	A ₂	Segment Driver	23	G ₁	Segment Driver
10	A _O	Decode Input	24	H	Segment Driver
11	CK	Clock	25	C _O	Segment Driver
12	A ₁	Decode Input	26	M	Segment Driver
13	A ₂	Decode Input	27	D ₂	Segment Driver
14	A ₃	Decode Input	28	J	Segment Driver

AC5947N
18 - SEGMENT DISPLAY DRIVER

DESCRIPTION OF 8-DIGIT APPLICATION USING AC5947N

Two example circuits are shown for driving an eight digit alphanumeric display in a digital or microprocessor system (figures 1 and 2).

In figure 1 the 7493 and 74145 provide the digit scanning. The message to be displayed is stored in memory and this data is accessed by the processor one character at a time and presented to the AC5947 in ASCII form. When this data is stable, the strobe line, which is normally high, is pulsed low. The low on the strobe line causes the display to be blanked and the latches in the AC5947 open, allowing the new character through to the decoder. At the same time, the 7493 advances to the next count and the digit is driven by the 74145. When the strobe returns to a high state, the ASCII data is latched and the display is unblanked. The blanking of the display while the decoder and digit scan are changing prevents ghosting.

The initialize line resets the digit scan to zero when it is pulsed high. This can be used to synchronize the display system with the microprocessor.

The 74145 has a maximum sink current capability of 80mA which means the peak segment current must be limited to 8mA, giving an average segment current of 1mA. Although the AC5947 can supply up to 64mA peak this means buffers must be added in the digit scan if increased segment current is required.

The circuit shown in figure 2 operates in a similar manner. However, here it is assumed that more output lines are available from the processor enabling the decoding function of the 7493 to be achieved by the processor itself. The 75498 is used as a buffer enabling a peak segment current of 12.5mA.

CHARACTER SET

TYPICAL 64 CHARACTER ASCII SET

		A ₃ A ₂ A ₁ A ₀																			
		0	1	2	3	4	5	6	7	8	9	A	B	C	D	E	F				
A ₅ A ₄	↓																				
	0 0	0	A	B	C	D	E	F	G	H	I	J	K	L	M	N	O				
	0 1	P	Q	R	S	T	U	V	W	X	Y	Z	[\]	↗	←				
	1 0		!	"	#	\$	%	&	'	<	>	*	+	,	-	.	/				
1 1	0	1	2	3	4	5	6	7	8	9	:	;	<	=	>	?					

FIGURE 1

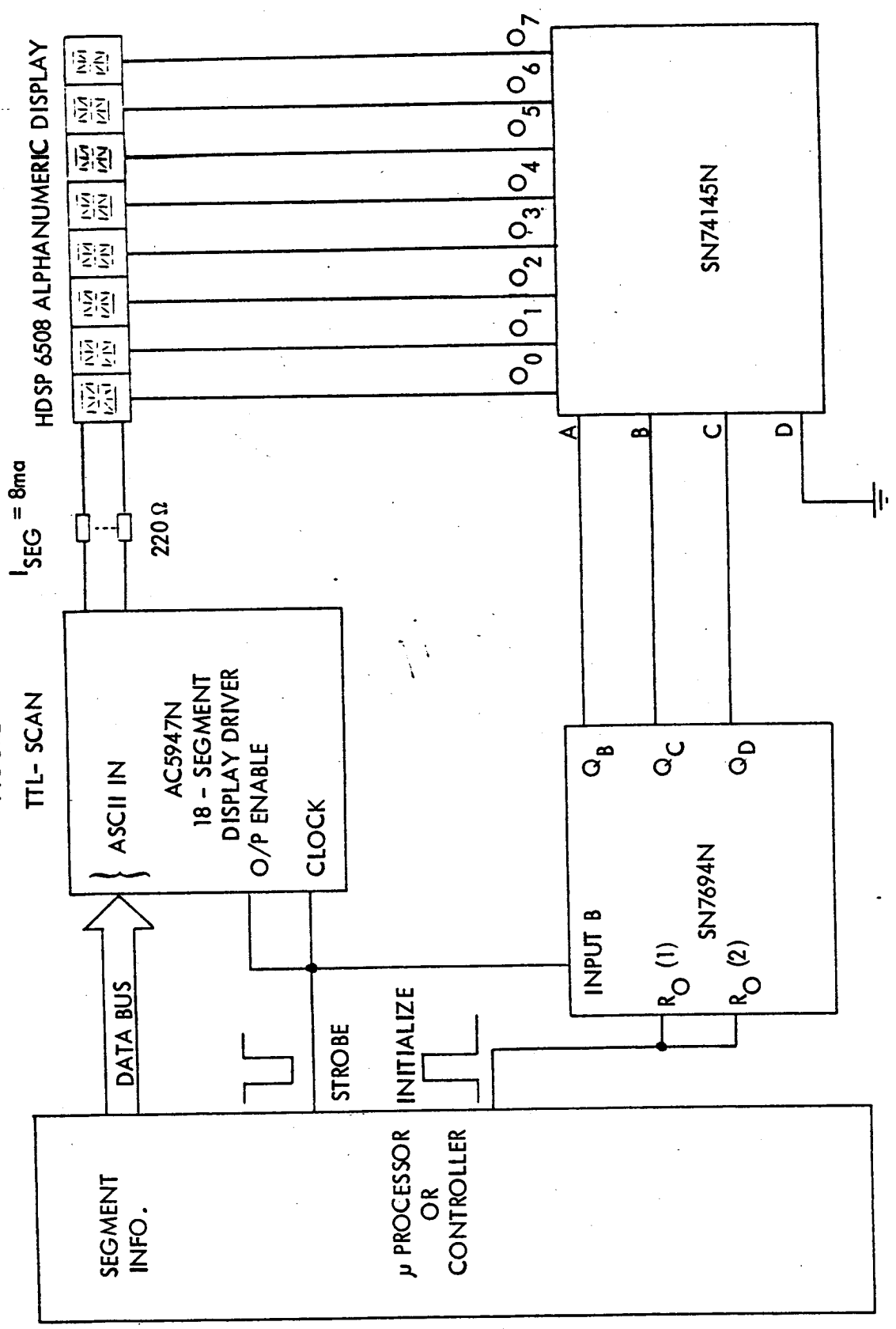

EXAMPLE μ P INTERFACE - FIGURE 2

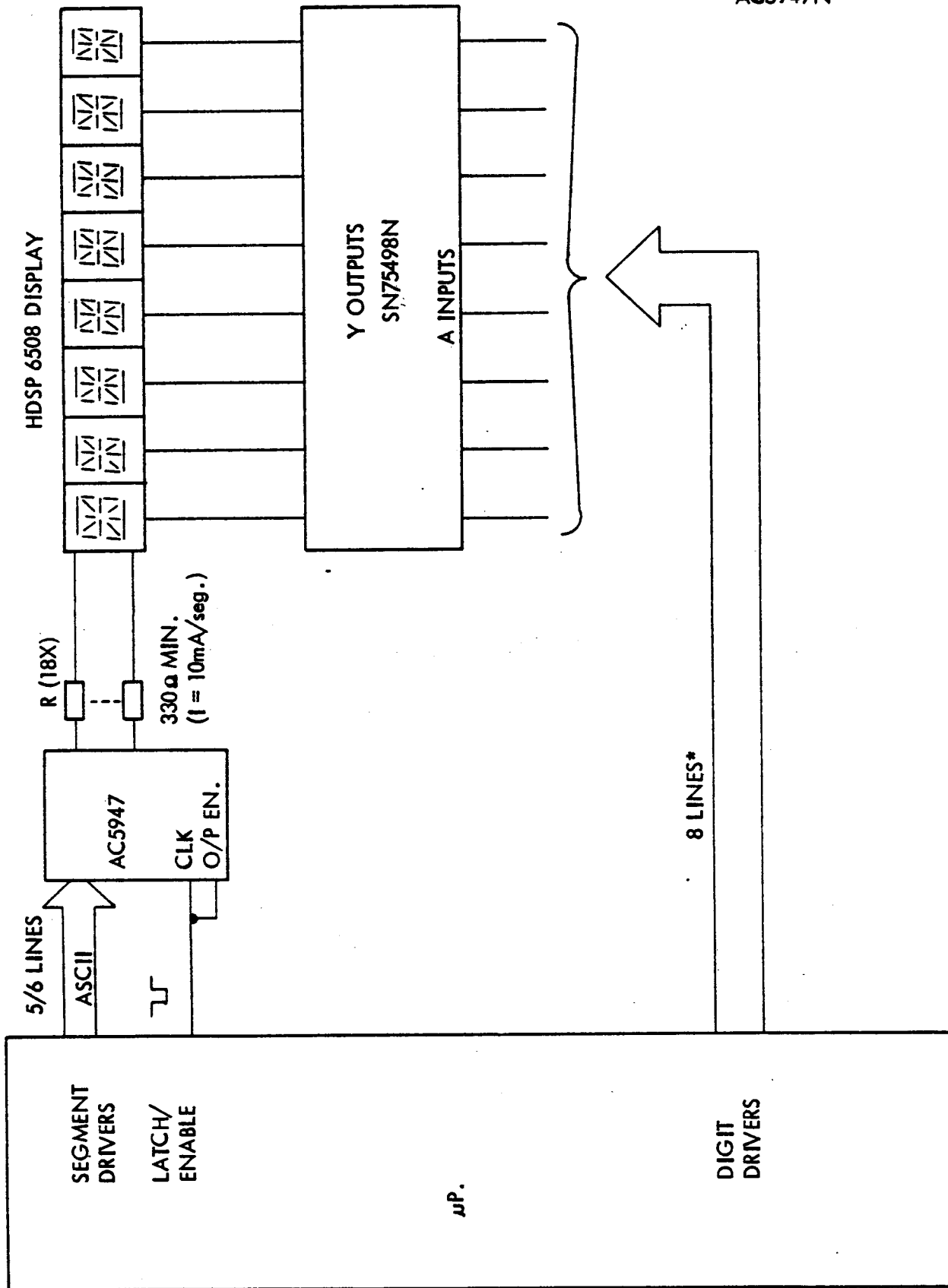

AC5947N

* TO RELIEVE LOAD ON μ P I/O, EXTERNAL DEMULT IPLEXERS AND/OR COUNTERS MAY BE USED.

ORDERING INSTRUCTIONS AND MECHANICAL DATA

general

The AC5947N is available in the standard dual-in-line plastic package with 0.600-inch (15,24-mm) centers (outline N), or in the smaller dual-in-line plastic package with 0.400-inch (10,16-mm) centers (outline NF). Orders for these circuits should include the package outline letter(s) at the end of the number; i.e., AC5947N or AC5947NF.

N package

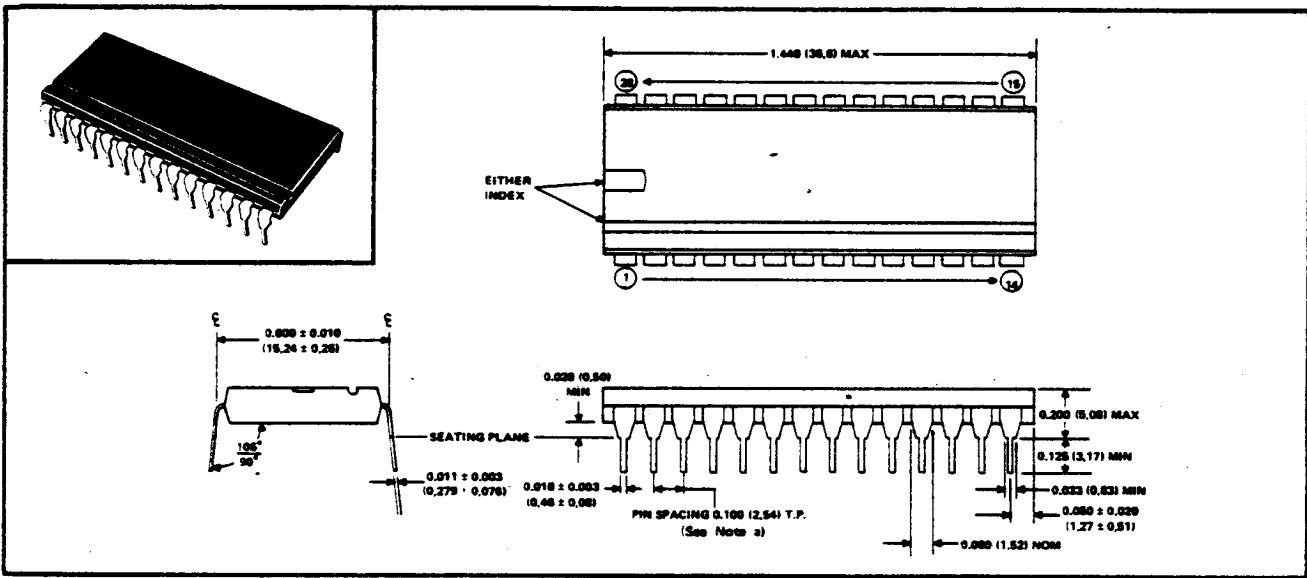

NF package

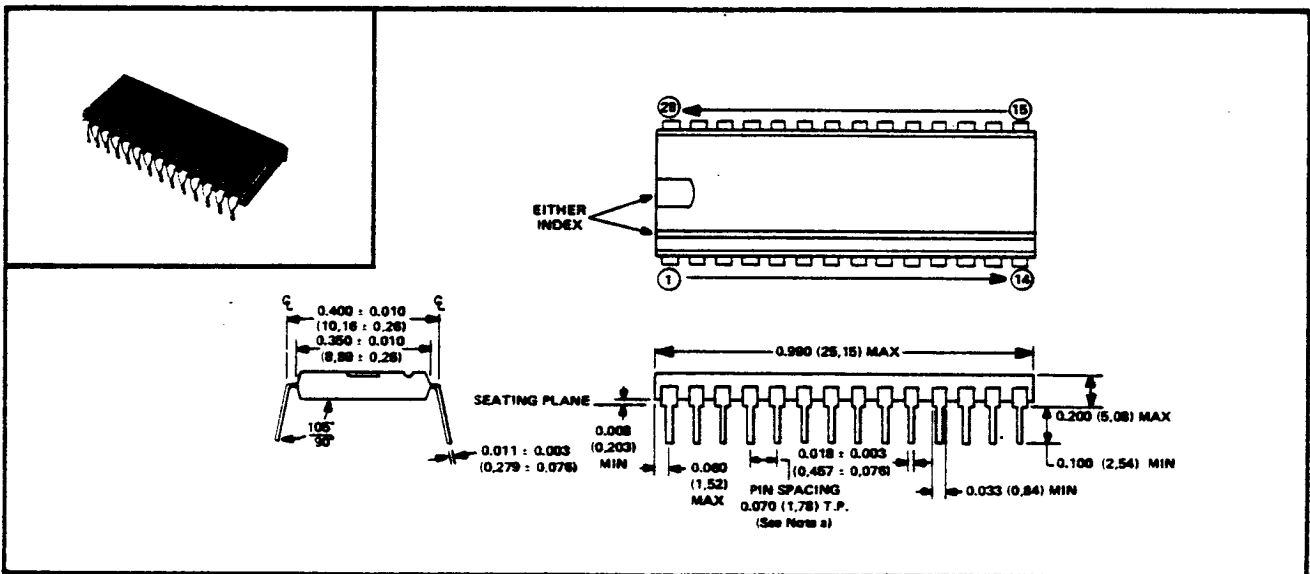

NOTES: a. Each pin centerline is located within 0.010 inch (0.26 millimeters) of its true longitudinal position.
b. All linear dimensions are shown in inches (and parenthetically in millimeters for reference only). Inch dimensions govern.