

# FG2000FX-50DA

HIGH POWER INVERTER USE  
PRESS PACK TYPE

## FG2000FX-50DA



- ITQRM Repetitive controllable on-state current .....2200A
- IT(AV) Average on-state current ..... 1050A
- VDRM Repetitive peak off state voltage .....2500V
- Anode short type

## OUTLINE DRAWING

Dimensions in mm

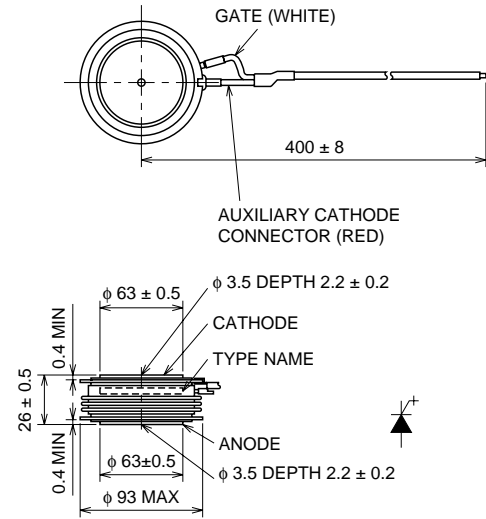

## APPLICATION

Inverters, D.C. choppers, Induction heaters, D.C. to D.C. converters.

## MAXIMUM RATINGS

Symbol	Parameter	Voltage class		Unit
		50DA		
VRRM	Repetitive peak reverse voltage	17		V
VRSM	Non-repetitive peak reverse voltage	17		V
VR(DC)	DC reverse voltage	17		V
VDRM	Repetitive peak off-state voltage*	2500		V
VD SM	Non-repetitive peak off-state voltage*	2500		V
VD(DC)	DC off-state voltage*	2000		V

\* : VGK = -2V

Symbol	Parameter	Conditions	Ratings	Unit
ITQRM	Repetitive controllable on-state current	V <sub>DM</sub> = 1875V, T <sub>j</sub> = 125°C, C <sub>s</sub> = 4.0μF, L <sub>s</sub> = 0.3μH	2200	A
IT(RMS)	RMS on-state current		1650	A
IT(AV)	Average on-state current	f = 60Hz, sine wave θ = 180°, T <sub>r</sub> = 73°C	1050	A
ITSM	Surge (non-repetitive) on-state current	One half cycle at 60Hz	16	kA
I <sup>2</sup> t	Current-squared, time integration	One cycle at 60Hz	10.5 × 10 <sup>5</sup>	A <sup>2</sup> s
diT/dt	Critical rate of rise of on-state current	V <sub>D</sub> = 1250V, I <sub>GM</sub> = 30A, T <sub>j</sub> = 125°C	1000	A/μs
VFGM	Peak forward gate voltage		10	V
VRGM	Peak reverse gate voltage		17	V
IFGM	Peak forward gate current		100	A
IRGM	Peak gate reverse current		650	A
PFGM	Peak forward gate power dissipation		280	W
PRGM	Peak reverse gate power dissipation		18	kW
PFG(AV)	Average forward gate power dissipation		50	W
PRG(AV)	Average reverse gate power dissipation		150	W
T <sub>j</sub>	Junction temperature		-40 ~ +125	°C
T <sub>stg</sub>	Storage temperature		-40 ~ +150	°C
—	Mounting force required	Recommended value 20	18 ~ 24	kN
—	Weight	Standard value	760	g

# FG2000FX-50DA

HIGH POWER INVERTER USE  
PRESS PACK TYPE

## ELECTRICAL CHARACTERISTICS

Symbol	Parameter	Test conditions	Limits			Unit
			Min	Typ	Max	
V <sub>TM</sub>	On-state voltage	T <sub>j</sub> = 125°C, I <sub>TM</sub> = 2000A, Instantaneous measurement	—	—	2.4	V
I <sub>RRM</sub>	Repetitive peak reverse current	T <sub>j</sub> = 125°C, V <sub>RRM</sub> Applied	—	—	50	mA
I <sub>DRM</sub>	Repetitive peak off-state current	T <sub>j</sub> = 125°C, V <sub>DRM</sub> Applied, V <sub>GK</sub> = -2V	—	—	50	mA
I <sub>RG</sub>	Reverse gate current	T <sub>j</sub> = 125°C, V <sub>RG</sub> = 17V	—	—	50	mA
dv/dt	Critical rate of rise of off-state voltage	T <sub>j</sub> = 125°C, V <sub>D</sub> = 1250V, V <sub>GK</sub> = -2V	1000	—	—	V/μs
t <sub>gt</sub>	Turn-on time	T <sub>j</sub> = 125°C, I <sub>TM</sub> = 2200A, I <sub>GM</sub> = 30A, V <sub>D</sub> = 1250V	—	—	10	μs
t <sub>gq</sub>	Turn-off time	T <sub>j</sub> = 125°C, I <sub>TM</sub> = 2200A, V <sub>DM</sub> = 1875V, di <sub>GQ</sub> /dt = -30A/μs V <sub>RG</sub> = 17V, C <sub>s</sub> = 4.0μF, L <sub>s</sub> = 0.3μH	—	—	30	μs
I <sub>GQM</sub>	Peak gate turn-off current		—	610	—	A
V <sub>GT</sub>	Gate trigger voltage	DC METHOD : V <sub>D</sub> = 24V, R <sub>L</sub> = 0.1Ω, T <sub>j</sub> = 25°C	—	—	1.5	V
I <sub>GT</sub>	Gate trigger current		—	—	2500	mA
R <sub>th(j-f)</sub>	Thermal resistance	Junction to fin	—	—	0.017	°C/W

## PERFORMANCE CURVES

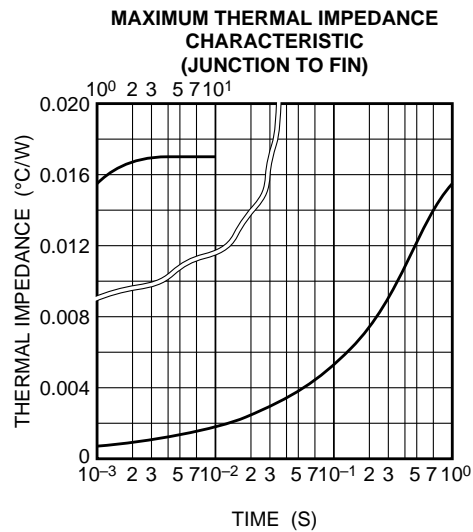
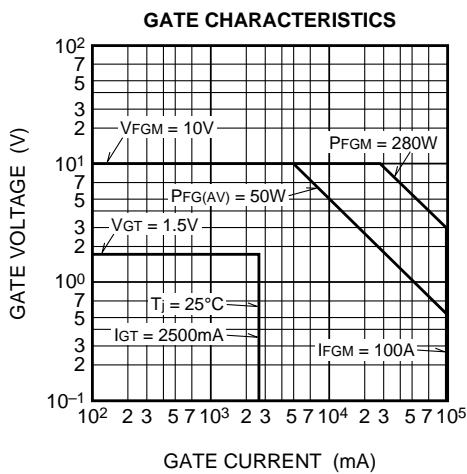
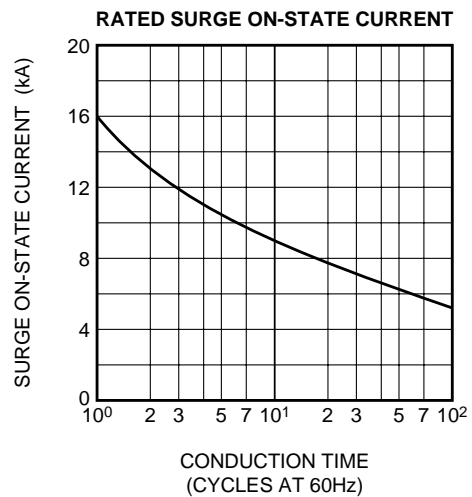
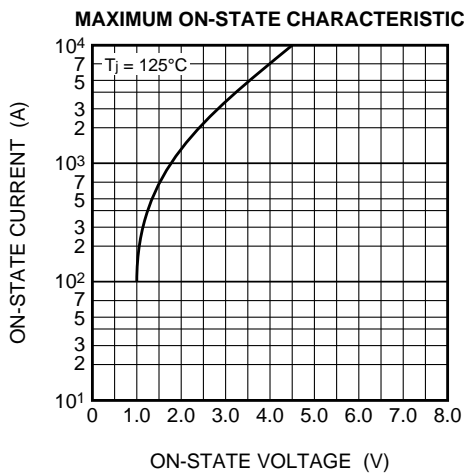

# FG2000FX-50DA

HIGH POWER INVERTER USE  
PRESS PACK TYPE

**MAXIMUM ON-STATE POWER DISSIPATION CHARACTERISTICS (SINGLE-PHASE HALF WAVE)**

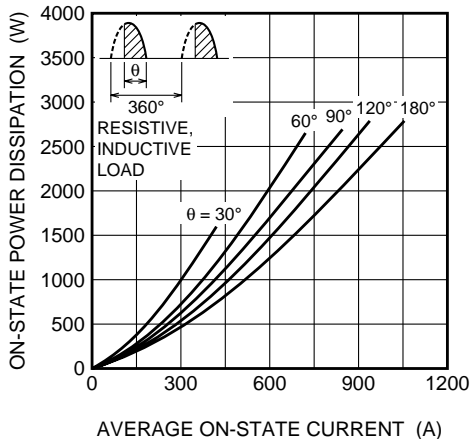

**ALLOWABLE FIN TEMPERATURE VS. AVERAGE ON-STATE CURRENT (SINGLE-PHASE HALF WAVE)**

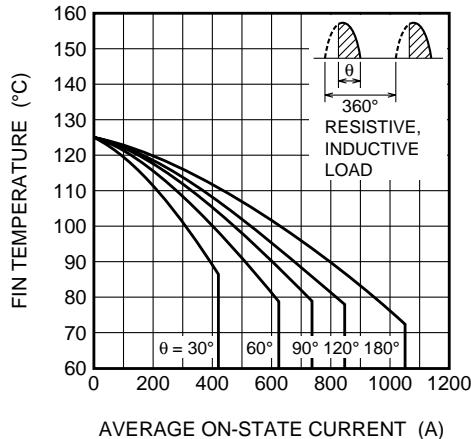

**MAXIMUM ON-STATE POWER DISSIPATION CHARACTERISTICS (RECTANGULAR WAVE)**

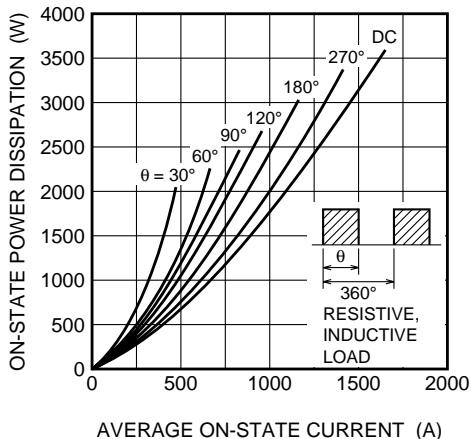

**ALLOWABLE FIN TEMPERATURE VS. AVERAGE ON-STATE CURRENT (RECTANGULAR WAVE)**

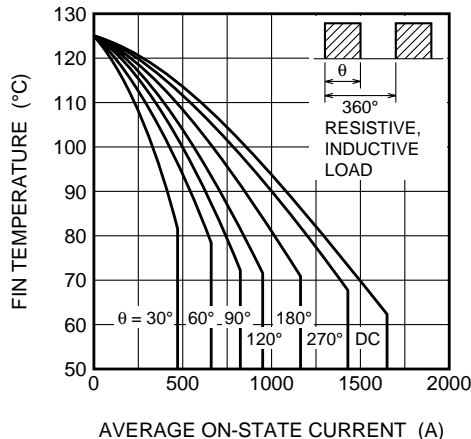

**GATE TRIGGER CURRENT VS. JUNCTION TEMPERATURE (TYPICAL)**

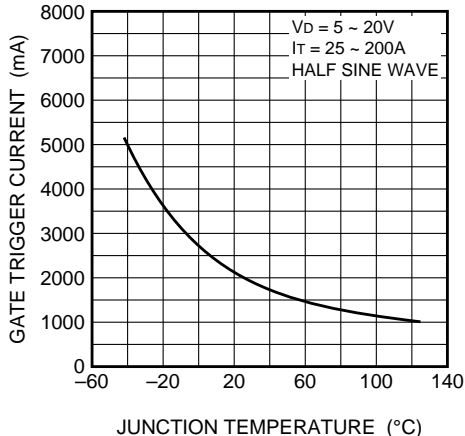

**TURN ON TIME, TURN ON DELAY TIME VS. TURN ON GATE CURRENT (TYPICAL)**

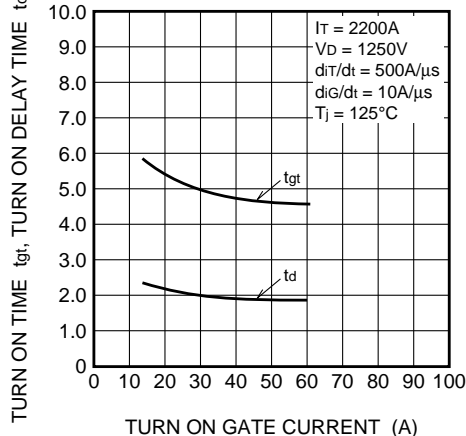

**FG2000FX-50DA**

HIGH POWER INVERTER USE  
PRESS PACK TYPE

