

# CTU/FMU

Rating/ Characteristics	Absolute Maximum Ratings						Electrical Characteristics (Ta = 25°C)					Others		
	V <sub>RSM</sub> (V)	V <sub>RM</sub> (V)	I <sub>o</sub> (A)	I <sub>FSM</sub> (A)	T <sub>j</sub> (°C)	T <sub>stg</sub> (°C)	V <sub>F</sub> (V)	I <sub>R</sub> (μA)	I <sub>R(H)</sub> (μA)	t <sub>rr</sub> (μs)	Outline Drawing	Weight(g)	Taping	Internal Connections
Type No.			With Fin	50Hz Half Wave Pulse Single			Max. per chip	I <sub>F</sub> (A)	V <sub>R</sub> = V <sub>RM</sub> max (per chip)	V <sub>R</sub> = V <sub>RM</sub> , T <sub>a</sub> = 100°C max (per chip)	I <sub>F</sub> /I <sub>RP</sub> (mA)			
CTU-G2DR	1350	1300	4.0	40	-40 ~ +140		2.0	4.0	100					
CTU-G3DR	1350	1300	6.0	60				6.0						
FMU-12S, R	250	200	5.0	30	-40 ~ +150			2.5	50	500	100/100		2.1	
FMU-14S, R	450	400												
FMU-16S, R	650	600												
FMU-21S, R	150	100												
FMU-22S, R	250	200	10	40				5.0						
FMU-24S, R	450	400												
FMU-26S, R	650	600												
FMU-32S, R	250	200												
FMU-34S, R	450	400	20	80				10						
FMU-36S, R	650	600												
CTU-12S, R	250	200	6.0	30	-40 ~ +140			3.0						
CTU-14S, R	450	400												
CTU-16S, R	650	600												
CTU-21S, R	150	100	8.0	40	-40 ~ +140		2.0	5.0			10/10		2.6	
CTU-22S, R	250	200												
CTU-24S, R	450	400												
CTU-26S, R	650	600												

Outline Drawing ④⑤

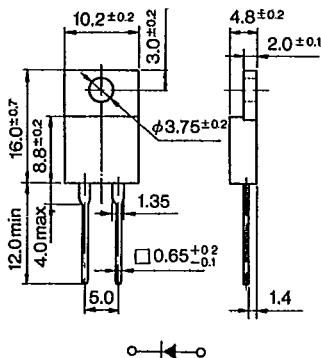

Outline Drawing ④⑥

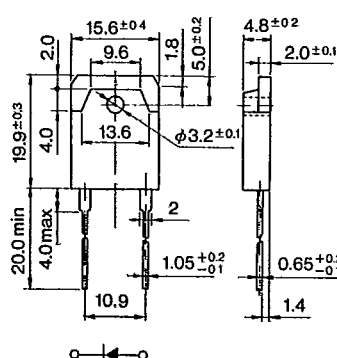

Outline Drawing ④⑦

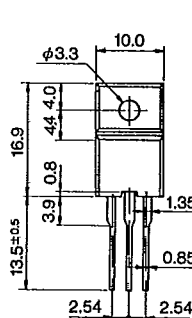

Outline Drawing ④⑧

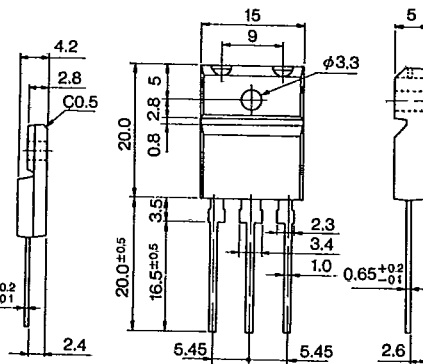

Outline Drawing ④⑨

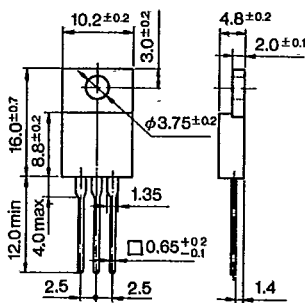

④⑤ ~ ④⑨ Plastic Molded Flammability: UL94V-0 or Equivalent

**CTU-G2R  
CTU-G3R**

**Io - Ta Deratings**

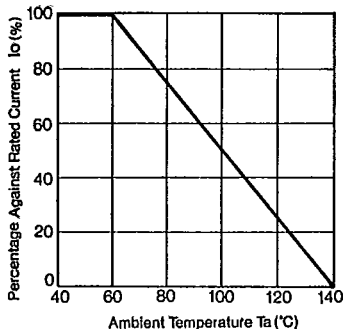

**FMU Series**

**PF(AV) - IF(AV) Characteristics**

**FMU-1**

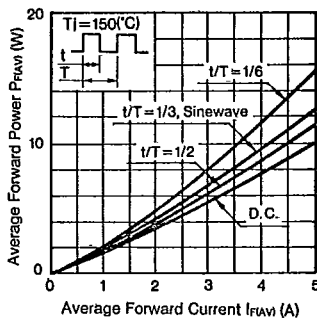

**FMU-2**

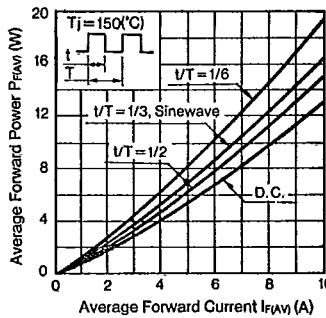

**FMU-3**

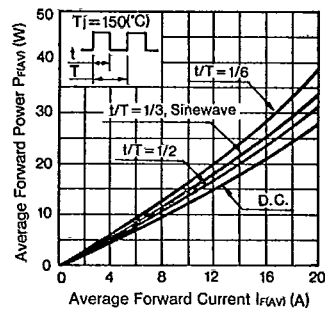

**CTU-1 Series**

**Io - Fin Characteristics**

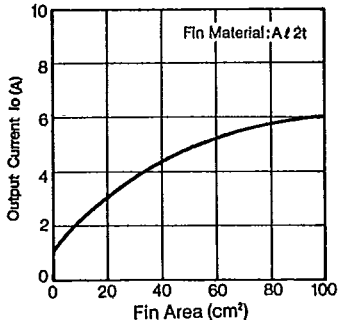

**Io - Ta Deratings**

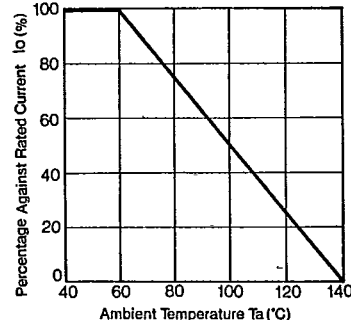

**CTU-2 Series**

**IF - VF Characteristics**

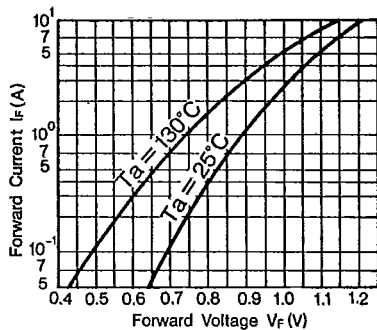

**IFSM Characteristics**

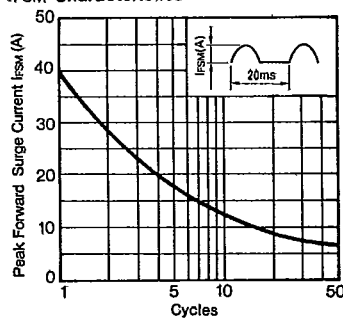

**Io - Ta Deratings**

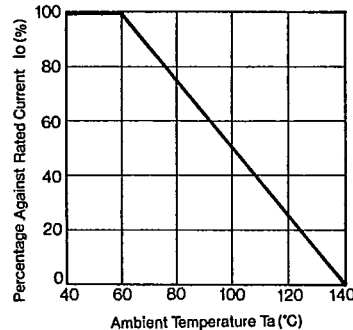

**Io - Fin Characteristics**

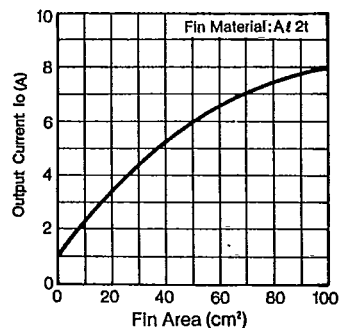

**CTU-22U**

**Io - Fin Characteristics**

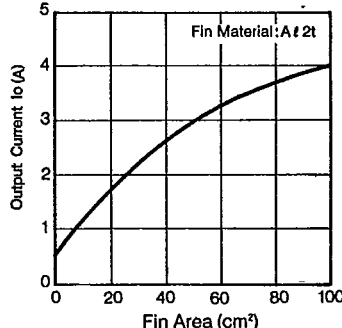

**Io - Ta Deratings**

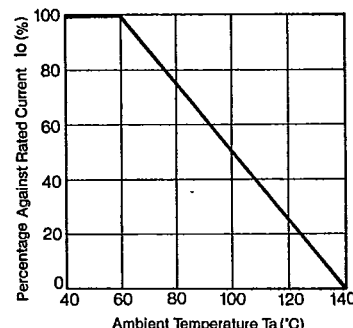

# Symbols/trr Measurement Circuit

## Symbols

$V_{RSM}$	Peak Reverse Surge Voltage	$I_{RSM}$	Peak Reverse Surge Current	$T_{stg}$	Storage Temperature
$V_{RM}$	Peak Reverse Voltage	$I_R$	Reverse Current	$t_{rr}$	Reverse Recovery Time
$V_{P-P}$	Reverse Voltage (Peak to Peak)	$I_{RP}$	Peak Reverse Current	$C_t$	Total Capacitance Between Terminals
$V_R$	Reverse Voltage	$I_{R(H)}$	Reverse Current (High Temperature)	$R_{th(j-c)}$	Thermal Resistance, Junction to Case
$V_F$	Forward Voltage	$I_Z$	Avalanche Current	$r_z$	Temperature Coefficient of Breakdown Voltage
$V_B$	Breakdown Voltage	$I_{ZSM}$	Allowable Avalanche Current	$R_z$	Equivalent Resistance of Breakdown Region
$I_o$	Average Rectified Forward Current	$T_a$	Ambient Temperature	$P_{F(AV)}$	Average Forward Power Dissipation
$I_F$	Forward Current	$T_j$	Junction Temperature	$I^2_t$	$I^2_t$ limiting Value
$I_{F(AV)}$	Average Forward Current	$T_{opr}$	Operating Ambient Temperature		
$I_{FSM}$	Peak Forward Surge Current	$T_c$	Case Temperature		

## Reverse Recovery Time Measurement Circuit

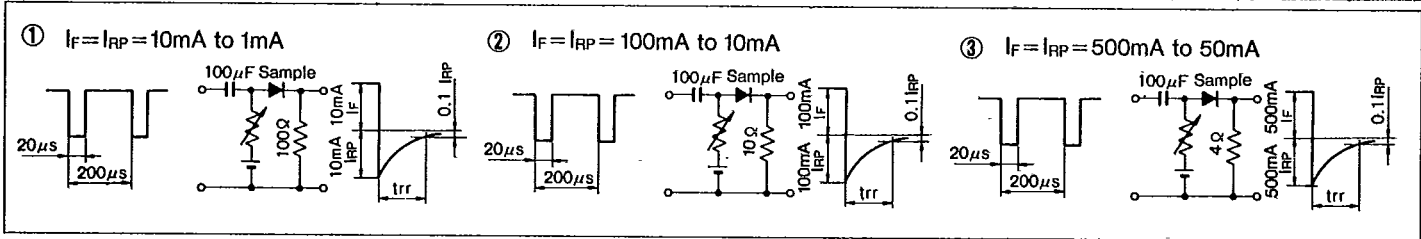

## Taping Specifications

Excluding High Voltage Diodes

Designation	Dimension (in mm)	Packaging Dimension and Marking	Quantity
<b>V</b> Add Suffix [V] to Type No.	<p><b>Tape Carrier Method</b></p> <p>(1) Right side of taping direction is cathode.                  (2) Place electrode side down when casing.                  (3) Provide leader tape of 150~200mm at beginning of tape.                  (4) Provide space of more than 10 pitches each for beginning and end of tape.</p>	<p><b>Reel</b></p> <p>Marking of Type No., Lot No. and Quantity</p>	1,800 pcs per reel
<b>V</b> Add Suffix [V] to type No.	<p><b>Axial Taping</b></p>	<p><b>Reel</b></p> <p>Markings of Type No. Lot No. and Quantity</p>	5,000 pcs per reel (2.7φ body)  3,000 pcs per reel (4.0φ body)

# Taping Specifications

Designation	Dimension (in mm)	Packaging Dimension and Marking	Quantity
<b>V1</b>  Add Suffix [V1] to Type No.	Axial Taping 	Ammunition Pack Broken Line: Perforation 	2,000 pcs per box (2.7 φ body)  1,000 pcs per box (4.0 φ body)
<b>VO</b>  Add Suffix [VO] to Type No.	Axial Taping 	Ammunition Pack Broken Line: Perforation 	2,000 pcs per box (2.7 φ body) (2.4 φ body)
<b>V3</b>  Add Suffix [V3] to Type No.	Axial Taping 	Reel Markings of Type No. Lot No. and Quantity 	1,500 pcs per reel (5.2 φ body)
<b>V4</b>  Add Suffix [V4] to Type No.	Axial Taping 	Ammunition Pack Broken Line: Perforation Trade Mark 	1,000 pcs per box (5.2 φ body)
<b>W</b>  Add Suffix [W] to Type No.	Radial Taping 	Ammunition Pack Broken Line: Perforation 	4,000 pcs per box (2.7 φ body) (0.6 φ lead)
<b>WS</b>  Add Suffix [WS] to Type No.	Radial Taping (Applicable to AO Series) 	Ammunition Pack Markings of Type No. Lot No. and Quantity 	2,500 pcs per box (2.4 φ body)
<b>WK</b>  Add Suffix [WK] to Type No.	Radial Taping (Applicable to AO Series) 		

# Marking Guide

## 1 Small TMD

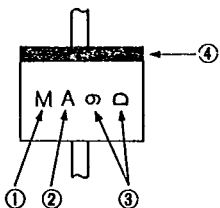

- ① Type Designation (in abbreviation)  
AM01 is abbreviated as M.
- ② Class Designation  
Z: 200V, No Letter: 400V, A: 600V
- ③ A: Year (Last Number of AD Year)  
B: Month (Jan. to Sept. are represented by numbers 1 to 9 respectively, and Oct., Nov., and Dec. are abbreviated as O, N and D respectively)
- ④ Cathode Band: Successive Band, however AU02 Type is Non-Successive Band.

## 2 E/EO Type TMD

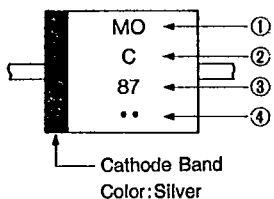

- ① Type Designation (in abbreviation)  
EM01 is abbreviated as MO, EM2 is abbreviated as M2.
- ② Class Designation  
Z: 200V, No Letter: 400V, A: 600V  
B: 800 V, C: 1000V, F: 1500V  
However, EU02A to be marked 2A, and EU2YX to be marked Y.
- ③ Abbreviations Representing Production Period  
A: Year (Last Number of AD Year)  
B: Month (1~9, O, N, D)
- ④ Production Period Divided in 3 ten day terms  
• : 1st 10days •• : 2nd 10days ••• : 3rd 10days

## 3 R Type TMD

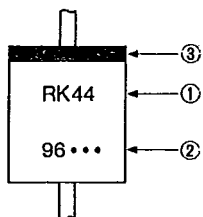

- ① Type Designation: Mark in 2 sets
- ② Production Period: Mark in 4 sets  
A: Year (Last Number of AD Year)  
B: Month (1~9, O, N, D)
- ③ Production Period Divided in 3 ten day terms  
• : 1st 10days •• : 2nd 10days ••• : 3rd 10days
- ④ Cathode Band Color: Silver: For Power Supply  
Yellow: For Middle Speed  
Red : For High Speed and Ultra-High Speed

## 4 RB40/60

(RB40 Series)

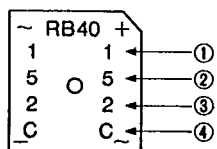

- ① Peak Reverse Voltage Designation  
1, 2, 4, 6, C  
Production Period
- ② Year (Last Number of AD Year)
- ③ Month (1~9, O, N, D)
- ④ Divided in 3 ten day terms  
A: 1st 10days, B: 2nd 10days  
C: 3rd 10days  
Color Designation: Silver

(RB60 Series)

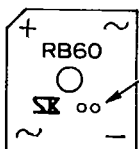

Dot Designation RB601 Violet  
RB602 No Color  
RB604 Blue  
RB606 White

## 5 RBV/RBA

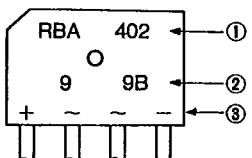

- ① Type Designation
- ② Lot Number  
1st : Year (Last Number of AD Year)  
2nd: Month (1~9, O, N, D)  
3rd : Divided 1~3 ten day Terms  
A: 1st 10 days B: 2nd 10 days  
C: 3rd 10 days
- ③ In-Put Designation

## 6 T0220 Type (FM or CT Type)

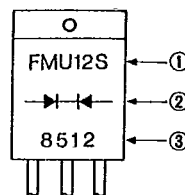

- ① Type Designation  
Show FMU-12S as FMU12S.
- ② Polarity: Rectifier Symbols
- ③ Lot Number (Laser Marking)  
1st : Year (Last Number of AD Year)  
2nd : Month (0~9, O, N, D)  
3rd, 4th: Day

## 7 T0220 Type (FM or CT Type, single chip)

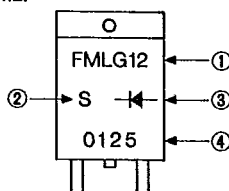

- ① Type Designation: Omit Last Letter  
Show FML-G12S as FMLG12.
- ② Last Letter of Type Designation
- ③ Polarity: Rectifier Symbols
- ④ Lot Number (Laser Marking)  
1st : Year (Last Number of AD Year)  
2nd : Month (0~9, O, N, D)  
3rd, 4th: Day

## 8 T03P Type (FM or CT Type)

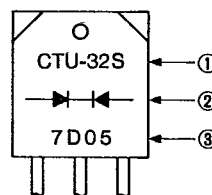

- ① Type shown in full designation  
However, CTB-34/34S/34M are marked as CTB-34, CTU-G3DR is marked as CTUG3DR.
- ② Polarity: Rectifier Symbols
- ③ Lot Number:  
1) M, U, G and L Types  
First Number : Last Digit of AD Year  
Second Number : Month  
Third and Fourth Numbers: Day  
Fifth Number : None  
2) For types CTB-34/34S/34M, the fifth letter shows type designation. If no fifth number, the type is CTB-33 or CTB-34.
- 3) Marking Color: Silver

## 9 MI-10/15 Type

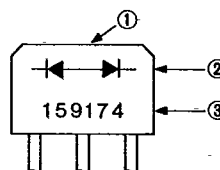

- ① MI-10/15 is die-stamped on the top of the case.
- ② Rectifier Symbols
- ③ Lot Number:  
First Number : Peak Reverse Voltage:  
(Letter) 0=50V, 1=100V, 2=200V,  
4=400V, 6=600V, C=1000V  
Second Number : Last Digit of AD Year  
Third Number : Month  
Fourth and Fifth Numbers: Day  
Sixth Number : Production number and  
U: Voltage Doubler Type

## 10 SFP Type

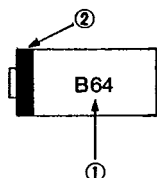

- ① Type Designation:  
SFPB-64 is abbreviated at B64,
- ② Cathode Band