

European Power-Semiconductor and Electronics Company

Marketing Information

FZ 1800 R 12 KF4

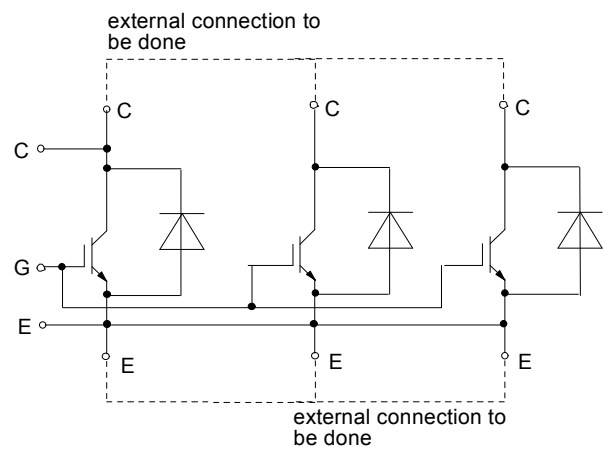
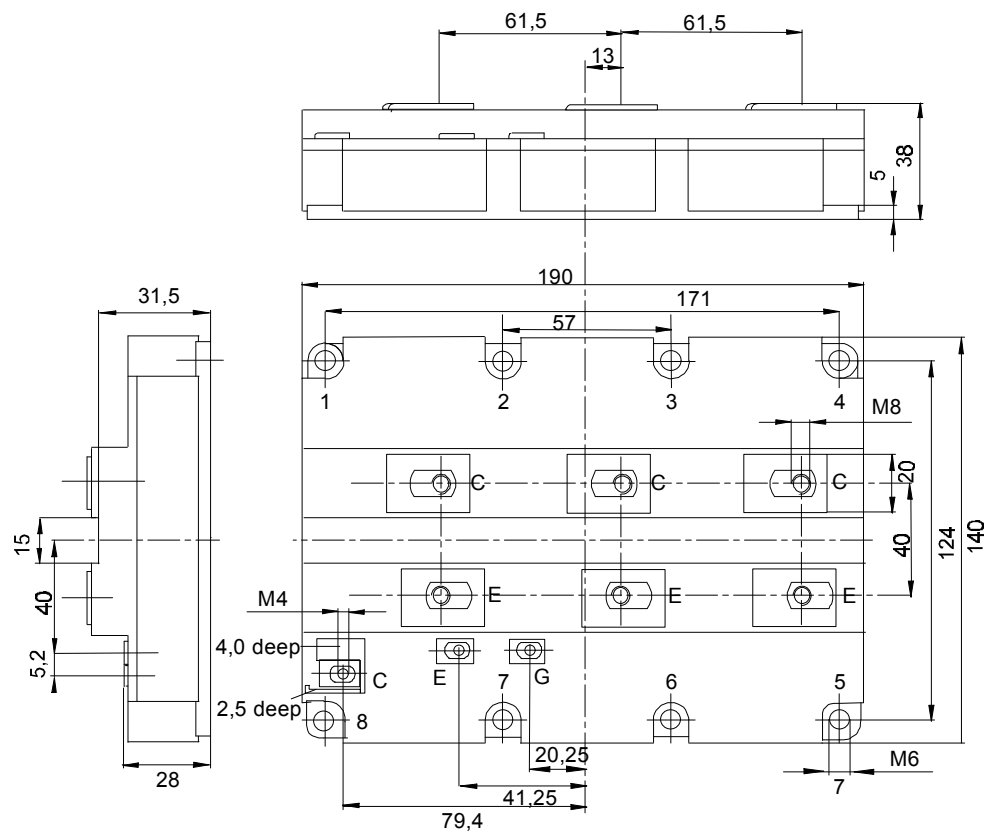

FZ 1800 R 12 KF4

Höchstzulässige Werte / Maximum rated values

Elektrische Eigenschaften / Electrical properties

Kollektor-Emitter-Sperrspannung	collector-emitter voltage		V_{CES}	1200 V
Kollektor-Dauergleichstrom	DC-collector current		I_C	1800 A
Period. Kollektor Spitzenstrom	repetitive peak collector current	$t_p=1\text{ ms}$	I_{CRM}	3600 A
Gesamt-Verlustleistung	total power dissipation	$t_c=25^\circ\text{C}$, Transistor	P_{tot}	11 kW
Gate-Emitter-Spitzenspannung	gate-emitter peak voltage		V_{GE}	+/- 20 V
Dauergleichstrom	DC forward current		I_F	1800 A
Periodischer Spitzenstrom	repetitive peak forw. current	$t_p=1\text{ ms}$	I_{FRM}	3600 A
Isolations-Prüfspannung	insulating test voltage	RMS, f=50 Hz, t= 1 min.	V_{ISOL}	2,5 kV

Charakteristische Werte / Characteristic values: Transistor

				min.	typ.	max
Koll.-Emitter Sättigungsspannung	coll.-emitter saturation voltage	$i_C=1,8\text{ kA}, v_{GE}=15\text{ V}, t_{vj}=25^\circ\text{C}$	$V_{CE\text{ sat}}$	-	2,7	3,2 V
		$i_C=1,8\text{ kA}, v_{GE}=15\text{ V}, t_{vj}=125^\circ\text{C}$		-	3,3	3,9 V
Gate-Schwellspannung	gate threshold voltage	$i_C=72\text{ mA}, v_{CE}=v_{GE}, t_{vj}=25^\circ\text{C}$	$V_{GE(th)}$	4,5	5,5	6,5 V
Eingangskapazität	input capacity	$f_o=1\text{ MHz}, t_{vj}=25^\circ\text{C}, v_{CE}=25\text{ V}, v_{GE}=0$	C_{ies}	-	135	- nF
Kollektor-Emitter Reststrom	collector-emitter cut-off current	$v_{CE}=1200\text{ V}, v_{GE}=0\text{ V}, t_{vj}=25^\circ\text{C}$	i_{CES}	-	-	30 mA
		$v_{CE}=1200\text{ V}, v_{GE}=0\text{ V}, t_{vj}=125^\circ\text{C}$		-	-	300 mA
Gate-Emitter Reststrom	gate leakage current	$v_{CE}=0\text{ V}, v_{GE}=20\text{ V}, t_{vj}=25^\circ\text{C}$	i_{GES}	-	-	400 nA
Emitter-Gate Reststrom	gate leakage current	$v_{CE}=0\text{ V}, v_{EG}=20\text{ V}, t_{vj}=25^\circ\text{C}$	i_{EGS}	-	-	400 nA
Einschaltzeit (ohmsche Last)	turn-on time (resistive load)	$i_C=1,8\text{ kA}, v_{CE}=600\text{ V}, v_L=15\text{ V}, v_L=15\text{ V}, R_G=0,43\Omega, t_{vj}=25^\circ\text{C}$	t_{on}	-	-	- μs
		$t_{vj}=125^\circ\text{C}$		-	-	- μs
Speicherzeit (induktive Last)	storage time	$i_C=1,8\text{ kA}, v_{CE}=600\text{ V}, v_L=15\text{ V}, v_L=15\text{ V}, R_G=0,43\Omega, t_{vj}=25^\circ\text{C}$	t_s	-	-	- μs
		$t_{vj}=125^\circ\text{C}$		-	-	- μs
Fallzeit (induktive Last)	fall time (inductive load)	$i_C=1,8\text{ kA}, v_{CE}=600\text{ V}, v_L=15\text{ V}, v_L=15\text{ V}, R_G=0,43\Omega, t_{vj}=25^\circ\text{C}$	t_f	-	-	- μs
		$t_{vj}=125^\circ\text{C}$		-	-	- μs

Bedingungen für den Kurzschlußschutz / Conditions for short-circuit protection

$t_{ig} = 10\mu\text{s}$	$V_{CC} = 750\text{V}$			
$v_L = \pm 15\text{V}$	$v_{CEM} = 900\text{V}$			
$R_{GF} = R_{GR} = 0,43\Omega$	$i_{CMK1} = 18000\text{V}$			
$t_{vj} = 125^\circ\text{C}$	$i_{CMK2} = 13500\text{V}$			
Unabhängig davon dilt bei abweichenden Bedingungen / with regard to other conditions			$v_{CEM} = V_{CES} - 12\text{nH} \cdot di_C/dt $	

Charakteristische Werte / Characteristic values: Invers-Diode

Durchlaßspannung	forward voltage	$i_F=1,8\text{ kA}, v_{GE}=0\text{ V}, t_{vj}=25^\circ\text{C}$	V_F	-	2,2	2,7 V
		$i_F=1,8\text{ kA}, v_{GE}=0\text{ V}, t_{vj}=125^\circ\text{C}$		-	2	2,5 V
Rückstromspitze	peak reverse recovery current	$i_F=1,8\text{ kA}, -di_F/dt=1,8\text{ kA}/\mu\text{s}$	I_{RM}	-	-	- A
		$v_{RM}=600\text{ V}, v_{EG}=10\text{ V}, t_{vj}=25^\circ\text{C}$		-	-	- A
Sperrverzögerungsladung	recovered charge	$i_F=1,8\text{ kA}, -di_F/dt=1,8\text{ kA}/\mu\text{s}$	Q_r	-	-	- μAs
		$v_{RM}=600\text{ V}, v_{EG}=10\text{ V}, t_{vj}=25^\circ\text{C}$		-	-	- μAs
		$v_{RM}=600\text{ V}, v_{EG}=10\text{ V}, t_{vj}=125^\circ\text{C}$		-	-	- μAs

Thermische Eigenschaften / Thermal properties

Innerer Wärmewiderstand	thermal resist., junction to case	Transistor / transistor, DC	R_{thJC}	0,011 °C/W
		Diode, DC		0,024 °C/W
Übergangs-Wärmewiderstand	thermal resist., case to heatsink	pro Module / per Module	R_{thCK}	0,006 °C/W
Höchstzul. Sperrschichttemp.	max. junction temperature	Transistor	$t_{vj\text{ max}}$	150 °C
Betriebstemperatur	operating temperature	Transistor / transistor	$t_{c\text{ op}}$	-40...+125 °C
Lagertemperatur	storage temperature		t_{stg}	-40...+125 °C

Mechanische Eigenschaften / Mechanical properties

Gehäuse, siehe Anlage	case, see appendix	Seite / page		1
Innere Isolation	internal insulation			Al_2O_3
Anzugsdrehm. f. mech. Befest.	mounting torque		M1	3 Nm
Anzugsdrehm. f. elektr. Anschl.	terminal connection torque	terminals M4	M2	2 Nm
		terminals M8		8...10 Nm
Gewicht	weight		G	ca.2300 g

Mit dieser technischen Information werden Halbleiterbauelemente spezifiziert, jedoch keine Eigenschaften zugesichert. Sie gilt in Verbindung mit den zugehörigen technischen Erläuterungen.
This technical information specifies semiconductor devices but promises no characteristics. It is valid in combination with the belonging technical notes.

eupec GmbH + Co KG, Max-Plank-Str. 5, D59581 Warstein, Telefon +49 (0)2902/764-0, Telefax /764-

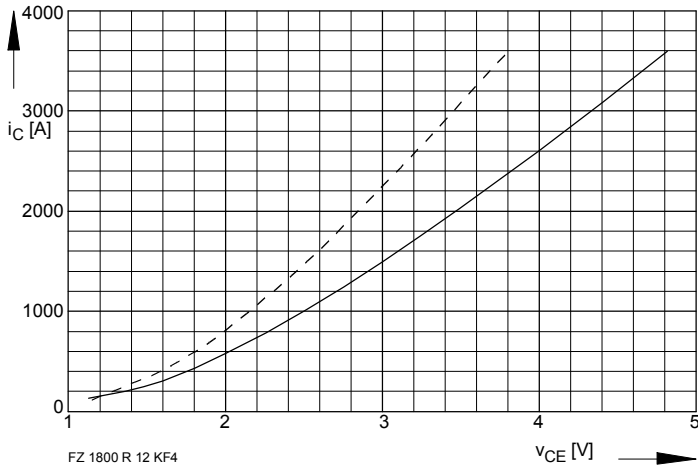

FZ 1800 R 12 KF4

Bild / Fig. 1
 Kollektor-Emitter-Spannung im Sättigungsbereich (typisch)
 Collector-emitter-voltage in saturation region (typical)
 $V_{GE} = 15V$
 - - - $t_{vj} = 25^{\circ}C$
 — $t_{vj} = 125^{\circ}C$

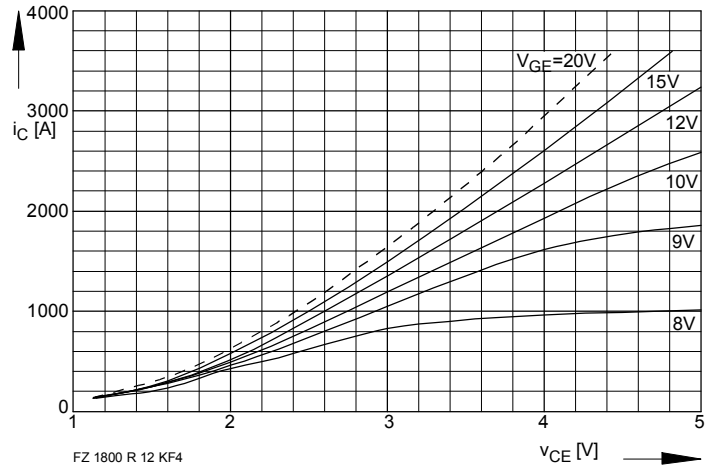

FZ 1800 R 12 KF4

Bild / Fig. 2
 Kollektor-Emitter-Spannung im Sättigungsbereich (typisch)
 Collector-emitter-voltage in saturation region (typical)
 $t_{vj} = 125^{\circ}C$

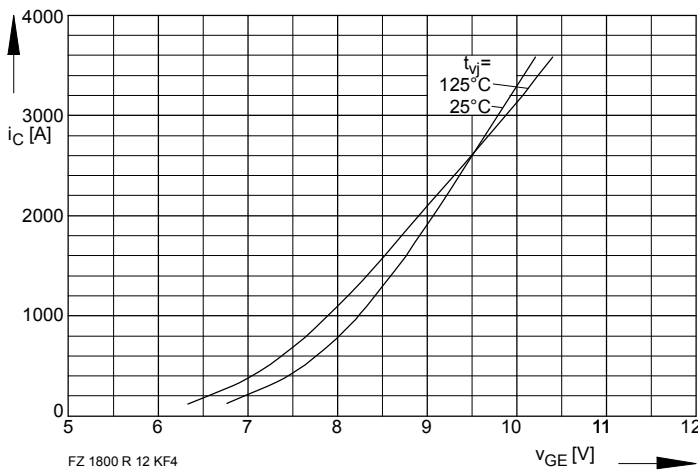

FZ 1800 R 12 KF4

Bild / Fig. 3
 Übertragungscharakteristik (typisch)
 Transfer characteristic (typical)
 $V_{CE} = 20V$

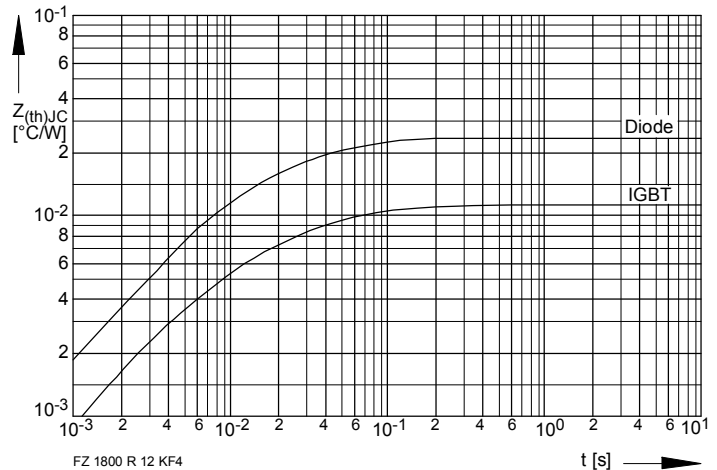

FZ 1800 R 12 KF4

Bild / Fig. 4
 Transient innerer Wärmewiderstand (DC)
 Transient thermal impedance (DC)

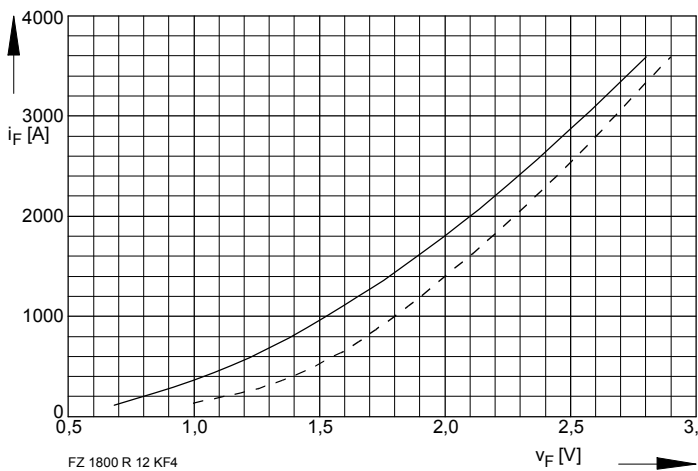

FZ 1800 R 12 KF4

Bild / Fig. 5
 Durchlaßkennlinie der Inversdiode (typisch)
 Forward characteristic of the inverse diode (typical)
 - - - $t_{vj} = 25^{\circ}C$
 — $t_{vj} = 125^{\circ}C$