

10/100 PC CARD LAN MAGNETICS SOLUTIONS

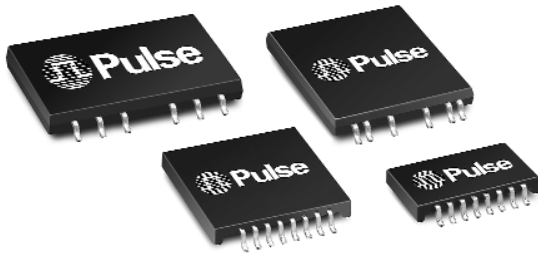

- Half port and single port designs for maximum layout flexibility
- Low profile packages from .094" (2,39 mm) to .078" (1,98 mm) for PC Card and Cardbus applications
- Compatible with Intel, TDK, QSI, and ICS transceivers

Electrical Specifications @ 25°C — Operating Temperature 0°C to 70°C

Part Number	Turns Ratio (±5%)		Insertion Loss 100 kHz-100 MHz (dB MAX)	Return Loss (dB MIN)			Differential to Common Mode Rejection (dB MIN)			Crosstalk (dB MIN)			Hipot (Vrms MIN)
	Transmit	Receive		30 MHz	60 MHz	80 MHz	30 MHz	50 MHz	100 MHz	30 MHz	62 MHz	100 MHz	
PE-69012	1:1	1:1	-1.3	-18	-13	-11	-40	-35	-30	-40	-40	-35	1500
H0001	√2:1	1:1	-2.0	-18	-12	-10	-30	-30	-30	-40	-40	-35	1500
H0002	1:1	1:1	-1.3	-18	-13	-11	-30	-30	-30	-40	-35	-30	1500
H0005	1:1*	1:1*	-17	-12	-10	-30	-30	-30	-30	—	—	—	1500
H0007	1:1	1:1	-1.3	-16	-12	-11	-15	-18	-20	-40	-40	-35	1500
H0009	1:1	1:1	-0.9	-16	-12	-11	-35	-33	-20	-50	-45	-40	1500
H0010	√2:1	1:1	-1.1	-17	-12	-10	-30	-30	-30	-40	-35	-30	1500
H0013	1:1	1:1	-0.9	-16	-12	-11	-35	-33	-20	-50	-45	-40	1500
H0019	1:1	1:1	-0.9	-18	-12	-11	-40	—	-30	-45	-45	-37	1500
H0020	1:1	1:1	-1.0	-16	-12	-12	-42	—	-33	-45	-40	-35	1500
H0022	1:1	1:1	-2.0	-18	-14	-12	-40	-35	-30	-50	-45	-40	1500
H0025	1:1	1:1	-2.0	-18	-12	-12	-40	-35	-30	-45	-45	-37	1500
H0026	1:1	1:1	-1.5	-18	-12	-12	-40	-35	-30	-45	-45	-37	1500

*H0005 can be used for transmit or receive channels.

Mechanicals

PE-69012, H0001

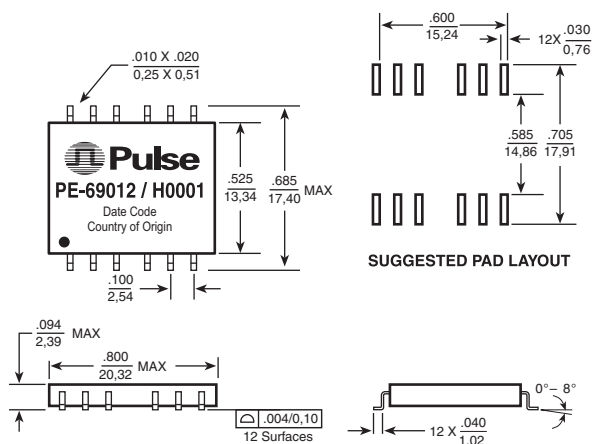

Weight 1.3 grams
Tape & Reel600/reel
Tube25/tube

H0002

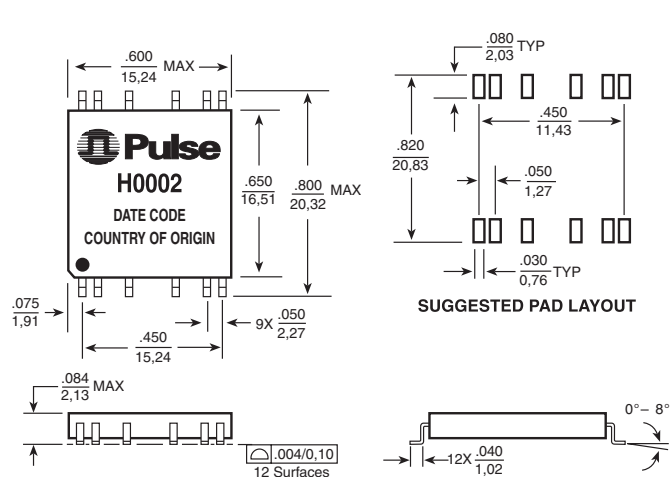

Dimensions: $\frac{\text{Inches}}{\text{mm}}$ Unless otherwise specified, all tolerances are $\pm \frac{.010}{0,25}$

Weight 1.2 grams
Tape & Reel900/reel
Tube35/tube

10/100 PC CARD LAN MAGNETICS SOLUTIONS



Mechanicals

H0005, H0013, H0019*

*The H0019 has a Max height of .084" (0,22 mm)

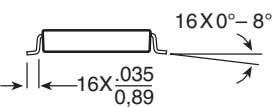
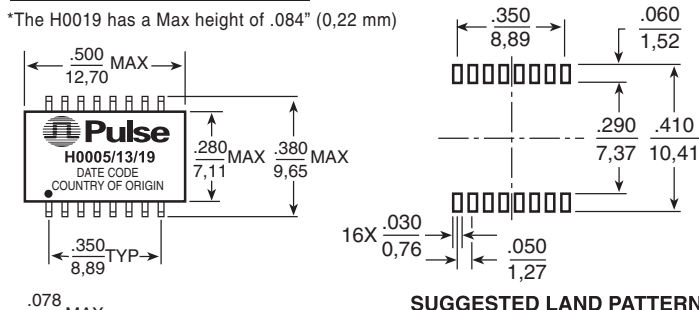

H0007, H0009, H0010

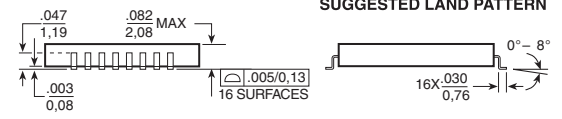
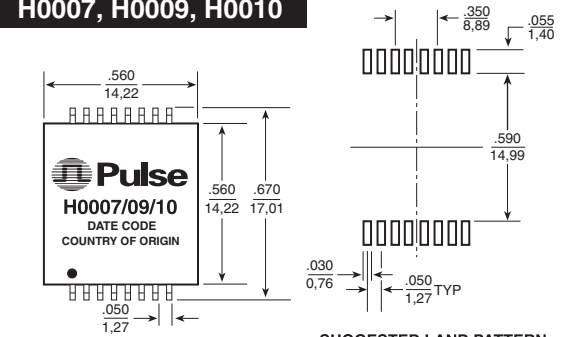

H0020

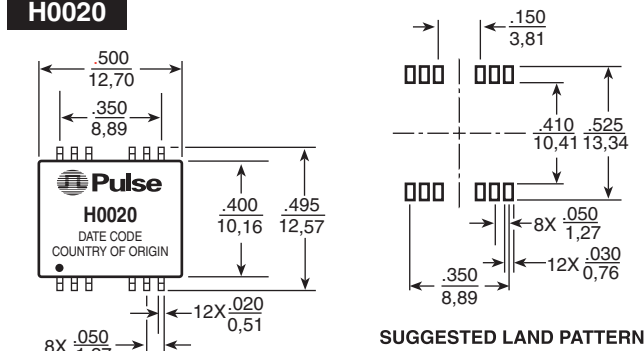

SUGGESTED LAND PATTERN

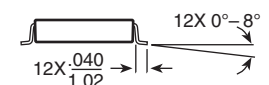

H0022, H0025

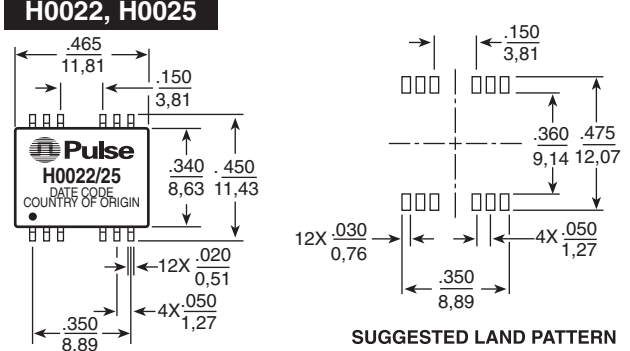

SUGGESTED LAND PATTERN

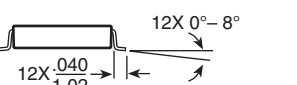

H0026

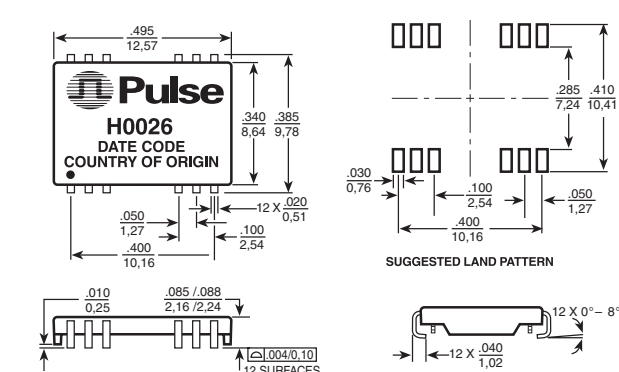

SUGGESTED LAND PATTERN

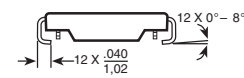

Dimensions: Inches
mm

Unless otherwise specified, all tolerances are ± .010 / 0,25

10/100 PC CARD LAN MAGNETICS SOLUTIONS



Schematics

PE-69012, H0001

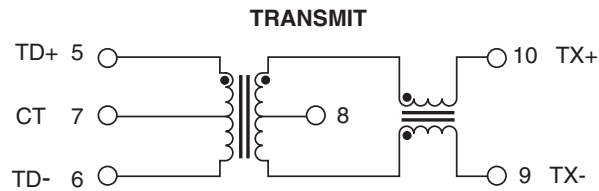
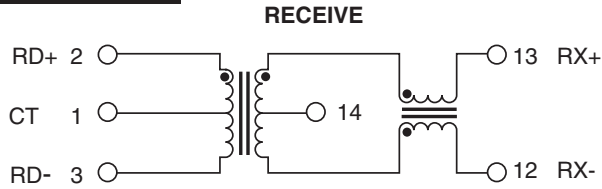

H0002

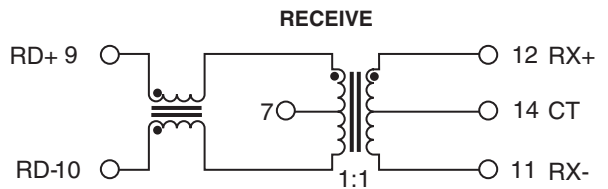
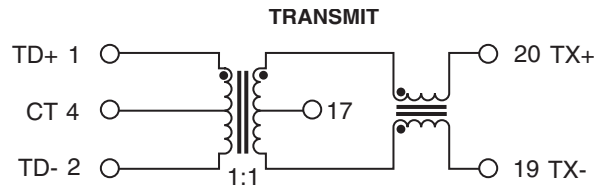

NOTE: Transmit and receive channels are interchangeable on the PE-69012.

H0005

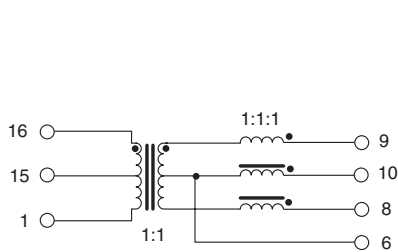

**H0007, H0009, H0013,
H0019, H0025**

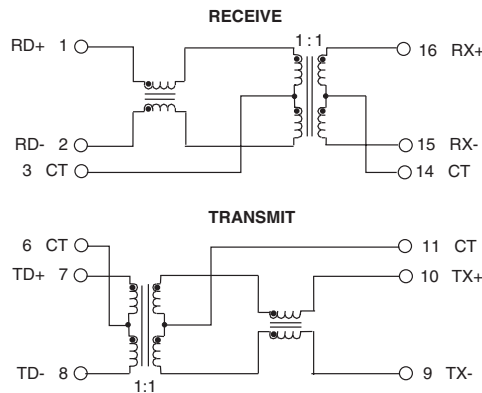

H0010

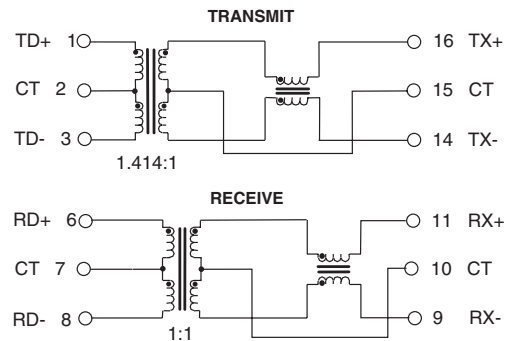

H0020

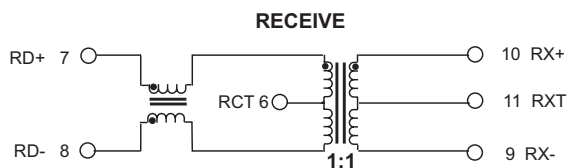
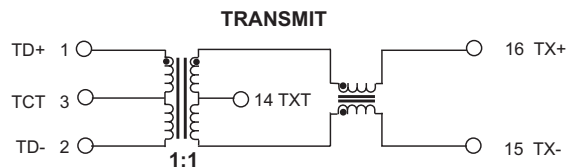

H0022, H0026

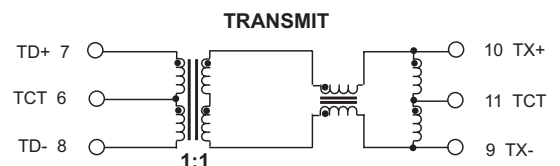
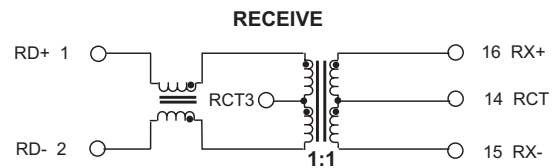

NOTE: The H0026 is IEEE 802.3 compliant.

10/100 PC CARD LAN MAGNETICS SOLUTIONS



Application Notes

The Pulse 10/100 PC Card modules provide isolation, impedance matching and noise attenuation in very low profile surface mount packages. This series provides various transmit turns ratios designed for use with the IC physical layer solutions offered by TDK, ICS, QSI and others.

Electrical Functions

Data integrity - The low profile magnetics modules are 100% tested to provide high reliable connectivity.

Equipment isolation - Each module is designed and 100% tested to provide 1500 Vrms minimum isolation per IEEE 802.3 requirements.

EMI suppression - High impedance common mode chokes attenuate signal harmonics which may contribute to radiated and conducted emissions. Transformer center-taps, when grounded, provide noise-shunting paths. The H0022 provides a shunt inductor on the transmit channel for additional noise suppression. Please note the recommended values and ratings of the bypass capacitors shown in the application circuit.

Mechanical Attributes

Design Flexibility - The H0005 is a half port design that offers additional flexibility in PCB layout. H0010 and H0013 are complete 10/100 single port solutions, offering the smallest over all board usage. Each device has a .078" (1,98 mm) maximum height package for use in the most height-restrictive applications. The H0022 maximum height is .085" (2,16 mm) to facilitate additional EMI performance with minimal sacrifice in footprint dimensions. The H0026 provides the industry's smallest IEEE compliant, five core design.

Process and Quality Standards

Process Integrity - The PE-69012, H0001 and H0002 offer IC-grade transfer molded packages and the H0005 through H0013 offer a bottom fill, leaded header type design. Both designs are suitable for high temperature IR reflow operations with peak temperature profiles up to 235°C.

Reliable Solder Connections - Compliant lead design provides a flexible lead resulting in excellent solder-joint reliability with ±.004" (0,10 mm) coplanarity.

All leads are solder-plated after final assembly to adhere to MIL-STD-202 (method 208) for solderability.

Note: All modules are packaged in tubes, unless Tape & Reel is specified. Please add the suffix "T" such as H0009T for Tape & Reel orders.

For More Information :

UNITED STATES (Worldwide)	UNITED KINGDOM (Northern Europe)	FRANCE (Southern Europe)	SINGAPORE (Southern Asia)	TAIWAN, R.O.C. (Northern Asia)	HONG KONG (China/Hong Kong)	DISTRIBUTOR
12220 World Trade Drive San Diego, CA 92128 U.S.A. http://www.pulseeng.com TEL: 619 674 8100 FAX: 619 674 8262	1 & 2 Huxley Road The Surrey Research Park Guildford, Surrey GU2 5RE United Kingdom TEL: 44 1483 401700 FAX: 44 1483 401701	Zone Industrielle F-39270 Orgelet France TEL: 33 3 84 35 04 04 FAX: 33 3 84 25 46 41	150 Kampong Ampat #07-01/02 KA Centre Singapore 368324 TEL: 65 287 8998 FAX: 65 280 0080	3F-4, No. 81, Sec. 1 HsinTai Wu Road Hsi-Chih, Taipei Hsien Taiwan, R.O.C. Tel: 886 2 2698 0228 FAX: 886 2 2698 0948	19/F, China United Plaza 1008 Tai Nan West Street Cheung Sha Wan, Kowloon Hong Kong, China TEL: 852 2788 6588 FAX: 852 2776 1055	

Performance warranty of products offered on this data sheet is limited to the parameters specified. Data is subject to change without notice. Other brand and product names mentioned herein may be trademarks or registered trademarks of their respective owners.

Printed on recycled paper. ©2002, all rights reserved. Pulse Engineering, Inc.

Application Circuits

