

## N - CHANNEL ENHANCEMENT MODE POWER MOS TRANSISTORS

TYPE	V <sub>DSS</sub>	R <sub>DS(on)</sub>	I <sub>D</sub>
IRF840	500 V	< 0.85 Ω	8 A
IRF840FI	500 V	< 0.85 Ω	4.5 A
IRF841	450 V	< 0.85 Ω	8 A
IRF841FI	450 V	< 0.85 Ω	4.5 A

- TYPICAL R<sub>DS(on)</sub> = 0.74 Ω
- AVALANCHE RUGGED TECHNOLOGY
- 100% AVALANCHE TESTED
- REPETITIVE AVALANCHE DATA AT 100°C

### APPLICATIONS

- HIGH CURRENT, HIGH SPEED SWITCHING
- SWITCH MODE POWER SUPPLIES (SMPS)
- CHOPPER REGULATORS, CONVERTERS, MOTOR CONTROL, LIGHTING FOR INDUSTRIAL AND CONSUMER ENVIRONMENT

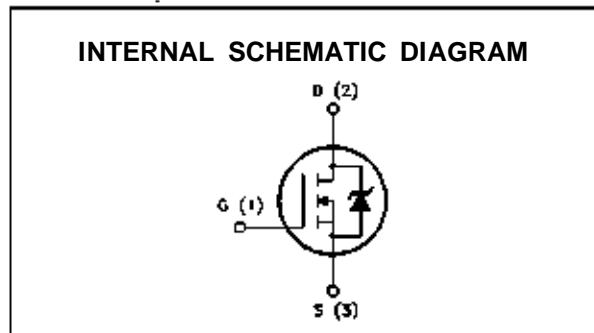
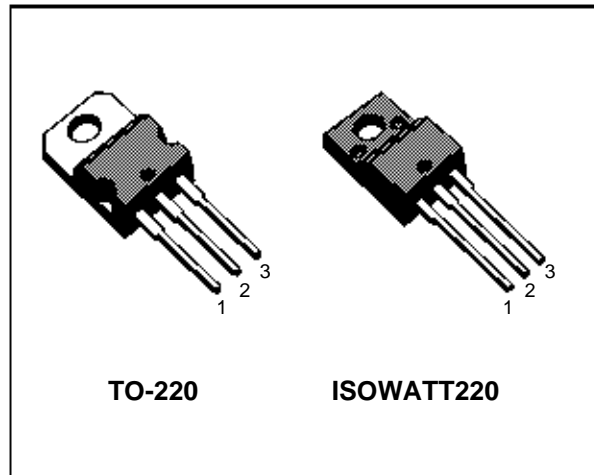

### ABSOLUTE MAXIMUM RATINGS

Symbol	Parameter	Value				Unit
		IRF				
		840	841	840FI	841FI	
V <sub>DS</sub>	Drain-source Voltage (V <sub>GS</sub> = 0)	500	450	500	450	V
V <sub>DGR</sub>	Drain- gate Voltage (R <sub>GS</sub> = 20 kΩ)	500	450	500	450	V
V <sub>GS</sub>	Gate-source Voltage	± 20				V
I <sub>D</sub>	Drain Current (cont.) at T <sub>c</sub> = 25 °C	8	8	4.5	4.5	A
I <sub>D</sub>	Drain Current (cont.) at T <sub>c</sub> = 100 °C	5.1	5.1	2.8	2.8	A
I <sub>DM</sub> (●)	Drain Current (pulsed)	32	32	32	32	A
P <sub>tot</sub>	Total Dissipation at T <sub>c</sub> = 25 °C	125		40		W
	Derating Factor	1		0.32		W/°C
V <sub>ISO</sub>	Insulation Withstand Voltage (DC)	—		2000		
T <sub>stg</sub>	Storage Temperature	-65 to 150				°C
T <sub>j</sub>	Max. Operating Junction Temperature	150				°C

(●) Pulse width limited by safe operating area

## IRF840/FI - IRF841/FI

### THERMAL DATA

		TO-220	ISOWATT220		
R <sub>thj-case</sub>	Thermal Resistance Junction-case	Max	1	3.12	°C/W
R <sub>thj-amb</sub>	Thermal Resistance Junction-ambient	Max	62.5		°C/W
R <sub>thc-s</sub>	Thermal Resistance Case-sink	Typ	0.5		°C/W
T <sub>l</sub>	Maximum Lead Temperature For Soldering Purpose		300		°C

### AVALANCHE CHARACTERISTICS

Symbol	Parameter	Max Value	Unit
I <sub>AR</sub>	Avalanche Current, Repetitive or Not-Repetitive (pulse width limited by T <sub>j</sub> max, δ < 1%)	8	A
E <sub>AS</sub>	Single Pulse Avalanche Energy (starting T <sub>j</sub> = 25 °C, I <sub>D</sub> = I <sub>AR</sub> , V <sub>DD</sub> = 25 V)	510	mJ
E <sub>AR</sub>	Repetitive Avalanche Energy (pulse width limited by T <sub>j</sub> max, δ < 1%)	13	mJ
I <sub>AR</sub>	Avalanche Current, Repetitive or Not-Repetitive (T <sub>c</sub> = 100 °C, pulse width limited by T <sub>j</sub> max, δ < 1%)	5.1	A

### ELECTRICAL CHARACTERISTICS (T<sub>case</sub> = 25 °C unless otherwise specified)

OFF

Symbol	Parameter	Test Conditions	Min.	Typ.	Max.	Unit
V <sub>(BR)DSS</sub>	Drain-source Breakdown Voltage	I <sub>D</sub> = 250 μA V <sub>GS</sub> = 0 for IRF840/840FI for IRF841/841FI	500 450			V V
I <sub>DSS</sub>	Zero Gate Voltage Drain Current (V <sub>GS</sub> = 0)	V <sub>DS</sub> = Max Rating V <sub>DS</sub> = Max Rating x 0.8 T <sub>c</sub> = 125 °C			250 1000	μA μA
I <sub>GSS</sub>	Gate-body Leakage Current (V <sub>DS</sub> = 0)	V <sub>GS</sub> = ± 20 V			± 100	nA

ON (\*)

Symbol	Parameter	Test Conditions	Min.	Typ.	Max.	Unit
V <sub>GS(th)</sub>	Gate Threshold Voltage	V <sub>DS</sub> = V <sub>GS</sub> I <sub>D</sub> = 250 μA	2	3	4	V
R <sub>DS(on)</sub>	Static Drain-source On Resistance	V <sub>GS</sub> = 10V I <sub>D</sub> = 4.4 A		0.74	0.85	Ω
I <sub>D(on)</sub>	On State Drain Current	V <sub>DS</sub> > I <sub>D(on)</sub> x R <sub>DS(on)max</sub> V <sub>GS</sub> = 10 V	8			A

### DYNAMIC

Symbol	Parameter	Test Conditions	Min.	Typ.	Max.	Unit
g <sub>fs</sub> (*)	Forward Transconductance	V <sub>DS</sub> > I <sub>D(on)</sub> x R <sub>DS(on)max</sub> I <sub>D</sub> = 4.4 A	4.9	6		S
C <sub>iss</sub>	Input Capacitance	V <sub>DS</sub> = 25 V f = 1 MHz V <sub>GS</sub> = 0		1100	1500	pF
C <sub>oss</sub>	Output Capacitance			190	240	pF
C <sub>rss</sub>	Reverse Transfer Capacitance			80	110	pF

**ELECTRICAL CHARACTERISTICS** (continued)

SWITCHING RESISTIVE LOAD

Symbol	Parameter	Test Conditions	Min.	Typ.	Max.	Unit
$t_{d(on)}$	Turn-on Time	$V_{DD} = 200\text{ V}$ $I_D = 4\text{ A}$ $R_i = 4.7\ \Omega$ (see test circuit)		40	50	ns
$t_r$	Rise Time			35	43	ns
$t_{d(off)}$	Turn-off Delay Time			80	100	ns
$t_f$	Fall Time			20	25	ns
$Q_g$	Total Gate Charge	$I_D = 8\text{ A}$ $V_{GS} = 10\text{ V}$ $V_{DD} = \text{Max Rating} \times 0.8$ (see test circuit)		75	95	nC
$Q_{gs}$	Gate-Source Charge			9		nC
$Q_{gd}$	Gate-Drain Charge			39		nC

SOURCE DRAIN DIODE

Symbol	Parameter	Test Conditions	Min.	Typ.	Max.	Unit
$I_{SD}$	Source-drain Current				8	A
$I_{SDM}(\bullet)$	Source-drain Current (pulsed)				32	A
$V_{SD} (*)$	Forward On Voltage	$I_{SD} = 8\text{ A}$ $V_{GS} = 0$			2	V
$t_{rr}$	Reverse Recovery Time	$I_{SD} = 8\text{ A}$ $di/dt = 100\text{ A}/\mu\text{s}$ $V_{DD} = 100\text{ V}$ $T_j = 150\text{ }^\circ\text{C}$		700		ns
$Q_{rr}$	Reverse Recovery Charge				12	$\mu\text{C}$

(\*) Pulsed: Pulse duration = 300  $\mu\text{s}$ , duty cycle 1.5 %  
 (•) Pulse width limited by safe operating area

Safe Operating Area for TO-220

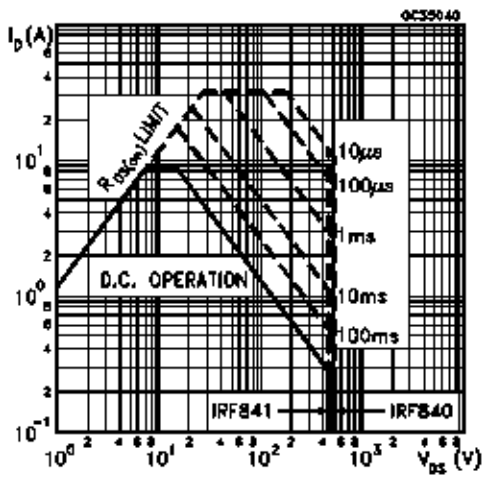

Safe Operating Area for ISOWATT220

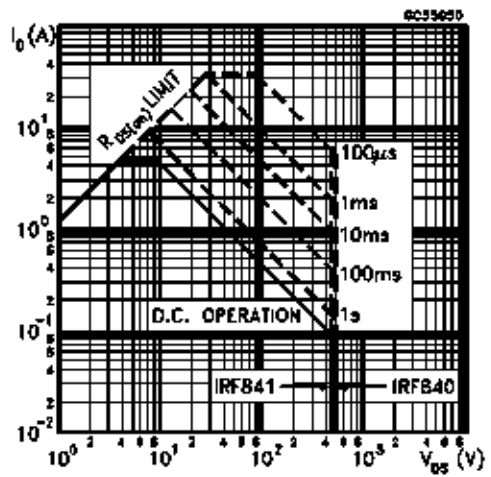

# IRF840/FI - IRF841/FI

Thermal Impedance for TO-220

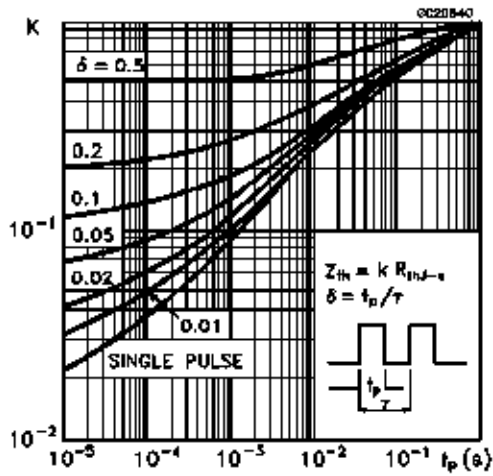

Thermal Impedance for ISOWATT220

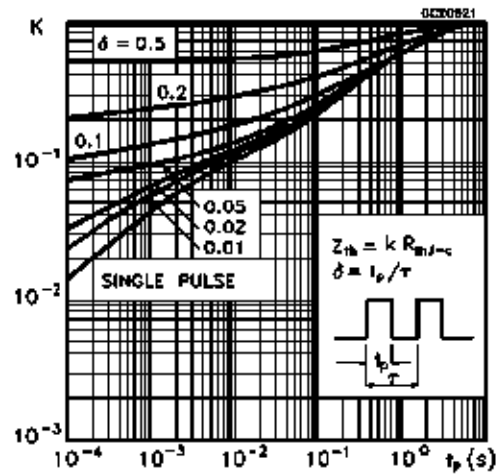

Derating Curve for TO-220

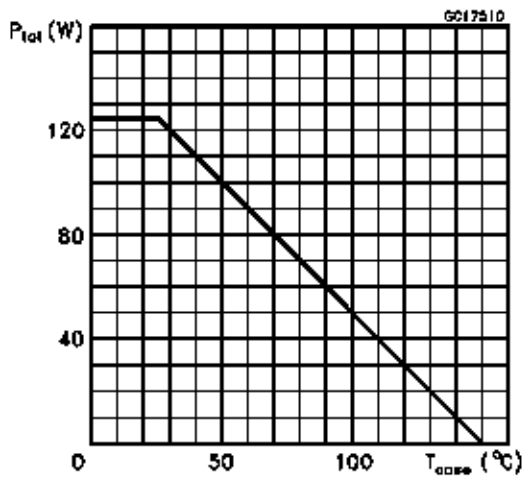

Derating Curve for ISOWATT220

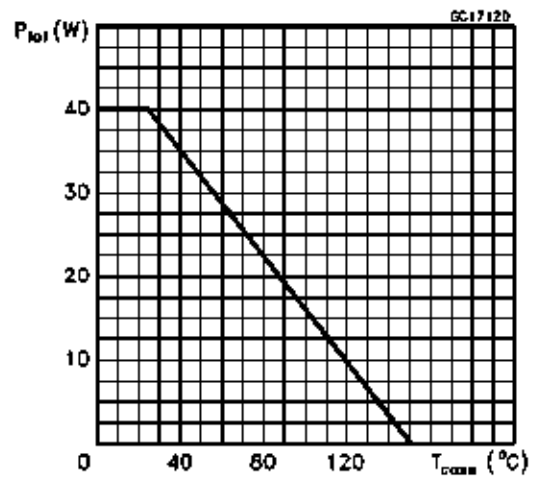

Output Characteristics

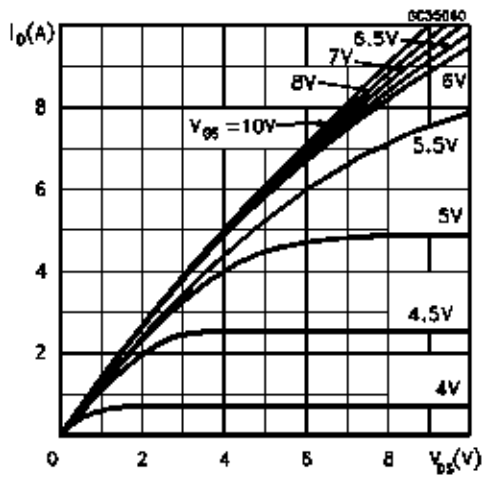

Output Characteristics

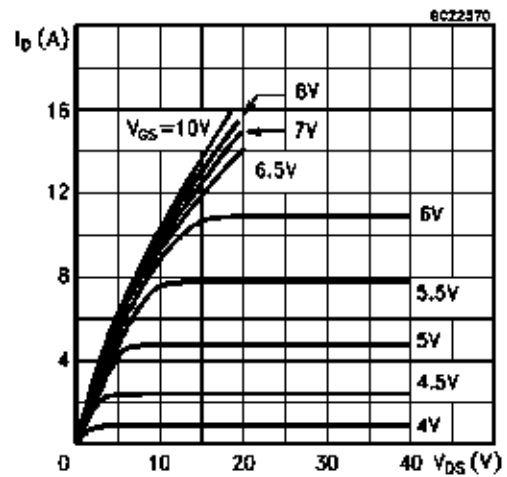

Transfer Characteristics

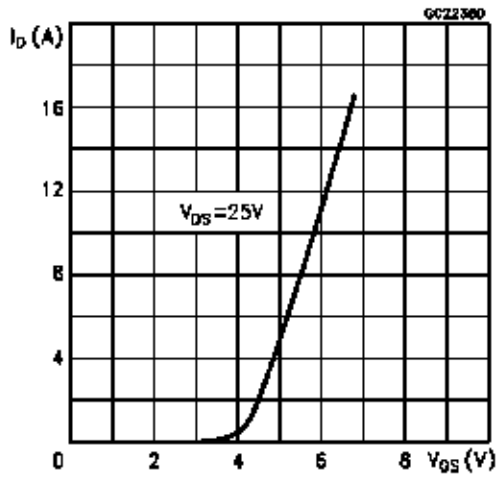

Transconductance

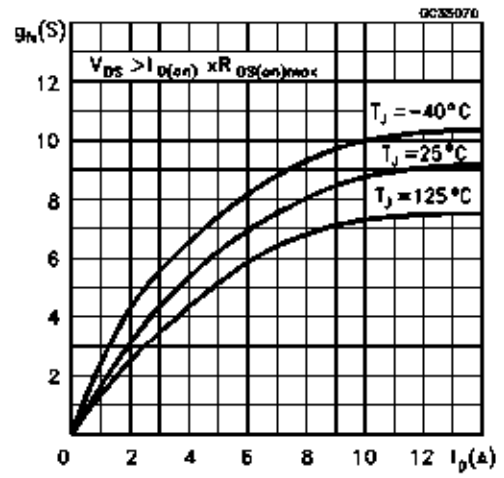

Static Drain-source On Resistance

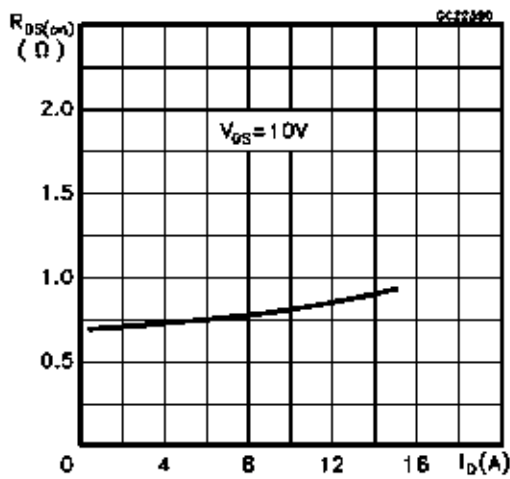

Maximum Drain Current vs Temperature

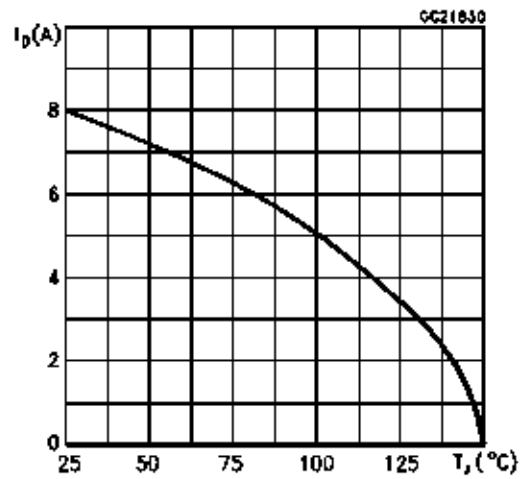

Gate Charge vs Gate-source Voltage

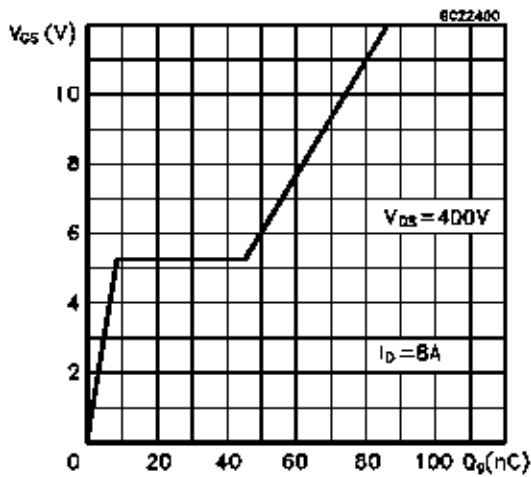

Capacitance Variations

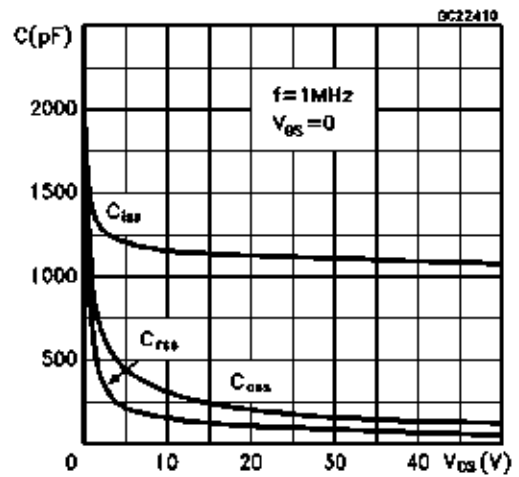

Normalized Breakdown Voltage vs Temperature

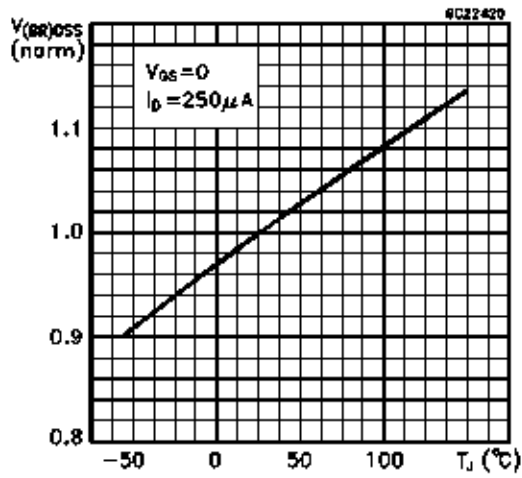

Normalized On Resistance vs Temperature

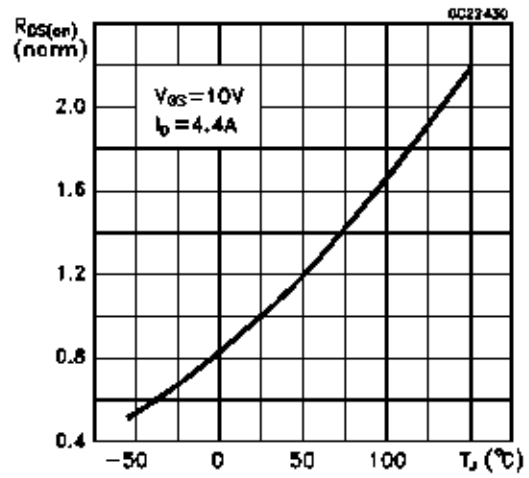

Source-drain Diode Forward Characteristics

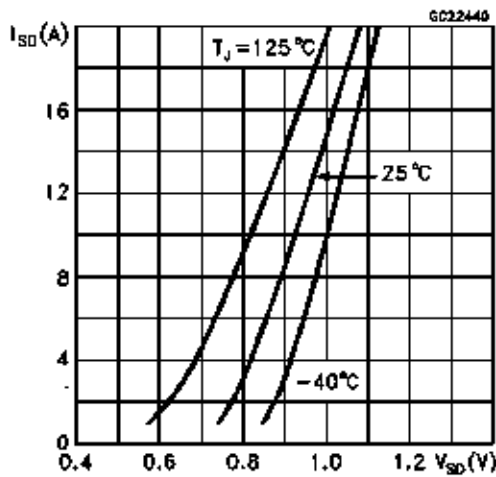

Unclamped Inductive Load Test Circuit

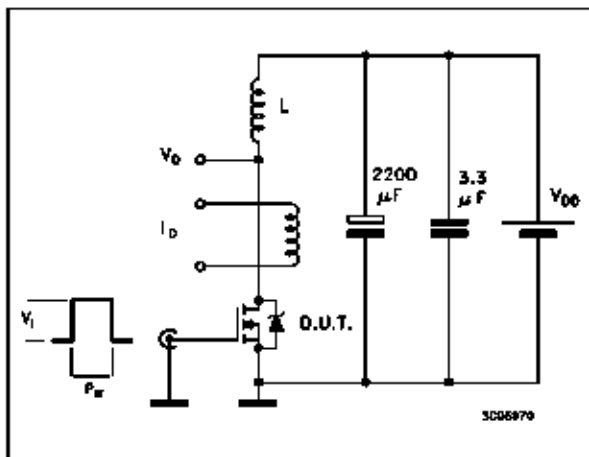

Unclamped Inductive Waveforms

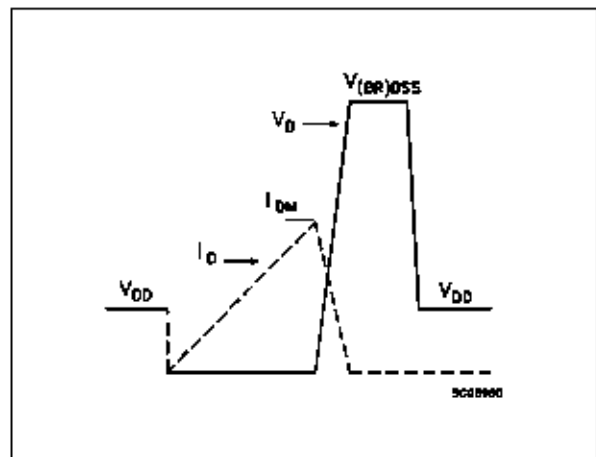

Switching Time Test Circuit

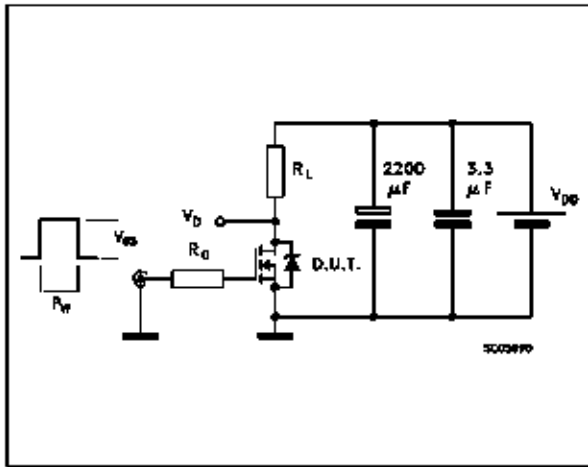

Gate Charge Test Circuit

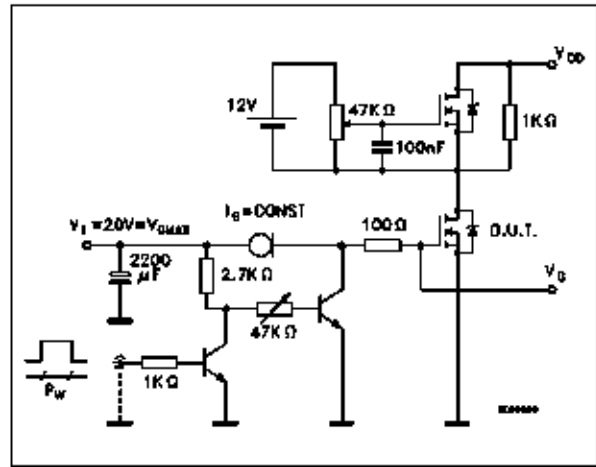

**TO-220 MECHANICAL DATA**

DIM.	mm			inch		
	MIN.	TYP.	MAX.	MIN.	TYP.	MAX.
A	4.40		4.60	0.173		0.181
C	1.23		1.32	0.048		0.051
D	2.40		2.72	0.094		0.107
D1		1.27			0.050	
E	0.49		0.70	0.019		0.027
F	0.61		0.88	0.024		0.034
F1	1.14		1.70	0.044		0.067
F2	1.14		1.70	0.044		0.067
G	4.95		5.15	0.194		0.203
G1	2.4		2.7	0.094		0.106
H2	10.0		10.40	0.393		0.409
L2		16.4			0.645	
L4	13.0		14.0	0.511		0.551
L5	2.65		2.95	0.104		0.116
L6	15.25		15.75	0.600		0.620
L7	6.2		6.6	0.244		0.260
L9	3.5		3.93	0.137		0.154
DIA.	3.75		3.85	0.147		0.151

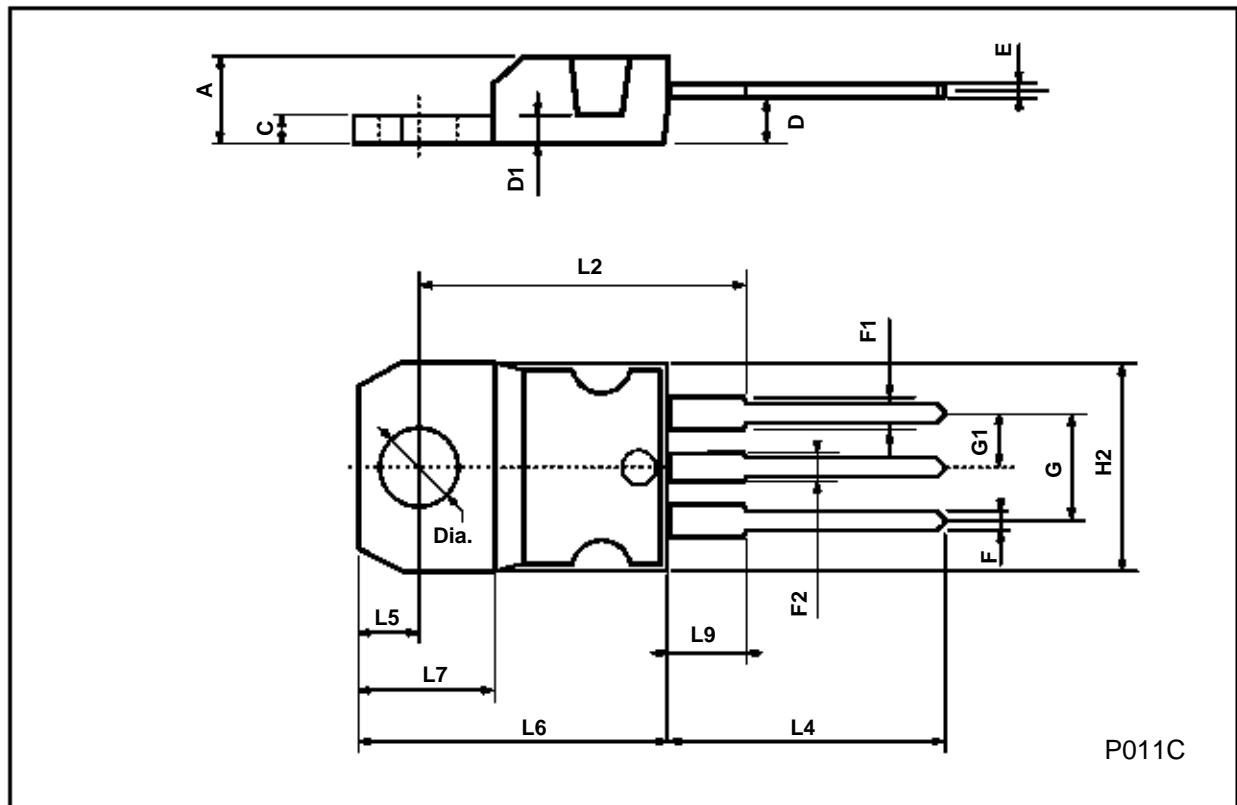



**ISOWATT220 MECHANICAL DATA**

DIM.	mm			inch		
	MIN.	TYP.	MAX.	MIN.	TYP.	MAX.
A	4.4		4.6	0.173		0.181
B	2.5		2.7	0.098		0.106
D	2.5		2.75	0.098		0.108
E	0.4		0.7	0.015		0.027
F	0.75		1	0.030		0.039
F1	1.15		1.7	0.045		0.067
F2	1.15		1.7	0.045		0.067
G	4.95		5.2	0.195		0.204
G1	2.4		2.7	0.094		0.106
H	10		10.4	0.393		0.409
L2		16			0.630	
L3	28.6		30.6	1.126		1.204
L4	9.8		10.6	0.385		0.417
L6	15.9		16.4	0.626		0.645
L7	9		9.3	0.354		0.366
∅	3		3.2	0.118		0.126

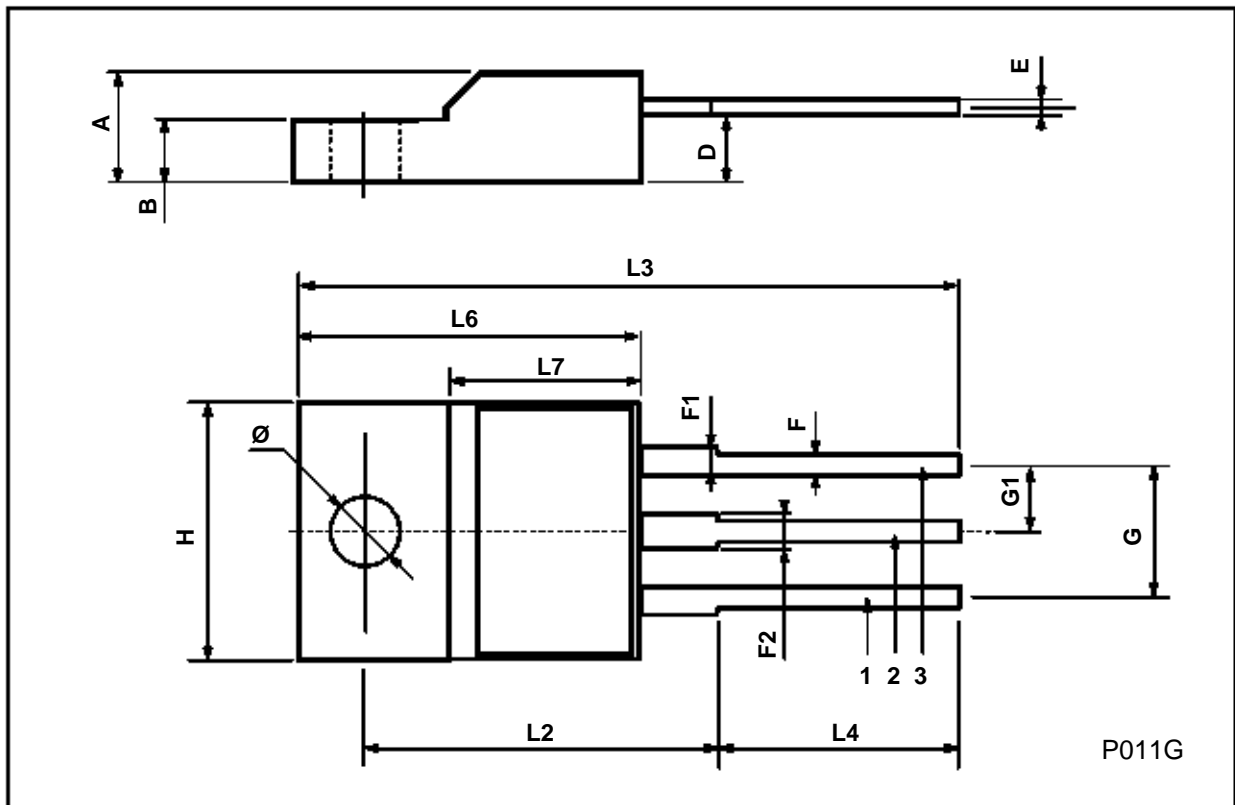

Information furnished is believed to be accurate and reliable. However, SGS-THOMSON Microelectronics assumes no responsibility for the consequences of use of such information nor for any infringement of patents or other rights of third parties which may result from its use. No license is granted by implication or otherwise under any patent or patent rights of SGS-THOMSON Microelectronics. Specifications mentioned in this publication are subject to change without notice. This publication supersedes and replaces all information previously supplied. SGS-THOMSON Microelectronics products are not authorized for use as critical components in life support devices or systems without express written approval of SGS-THOMSON Microelectronics.

© 1994 SGS-THOMSON Microelectronics - All Rights Reserved

SGS-THOMSON Microelectronics GROUP OF COMPANIES  
Australia - Brazil - France - Germany - Hong Kong - Italy - Japan - Korea - Malaysia - Malta - Morocco - The Netherlands -  
Singapore - Spain - Sweden - Switzerland - Taiwan - Thailand - United Kingdom - U.S.A