

# M54563P/FP

8-UNIT 500mA SOURCE TYPE DARLINGTON TRANSISTOR ARRAY WITH CLAMP DIODE

## DESCRIPTION

M54563FP is an eight-circuit output-sourcing Darlington transistor array. The circuits are made of PNP and NPN transistors. This semiconductor integrated circuit performs high-current driving with extremely low input-current supply.

## FEATURES

- High breakdown voltage ( $BV_{CEO} \geq 50V$ )
- High-current driving ( $I_{o(max)} = -500mA$ )
- With clamping diodes
- Driving available with PMOS IC output of 6 ~ 16V or with TTL output
- Wide operating temperature range ( $T_a = -20$  to  $+75^\circ C$ )
- Output current-sourcing type

## APPLICATION

Drives of relays, printers, LEDs, fluorescent display tubes and lamps, and interfaces between MOS-bipolar logic systems and relays, solenoids, or small motors

## FUNCTION

The M54563P and M54563FP each have eight circuits, which are made of input inverters and current-sourcing outputs. The outputs are made of PNP transistors and NPN Darlington transistors. The PNP transistor base current is constant. A clamping diode is provided between each output and GND.  $V_s$  and GND are used commonly among the eight circuits.

The inputs have resistance of  $3k\Omega$ , and voltage of up to 10V is applicable. Output current is 500 mA maximum. Supply voltage  $V_s$  is 50V maximum.

The M54563FP is enclosed in a molded small flat package, enabling space-saving design.

## PIN CONFIGURATION

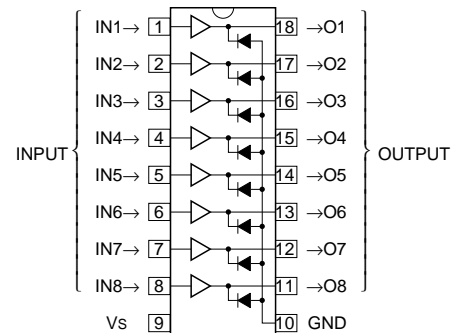

Package type 18P4G(P)

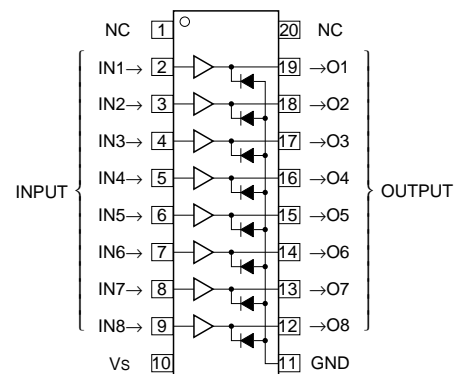

Package type 20P2N-A(FP)

NC : No connection

## CIRCUIT DIAGRAM

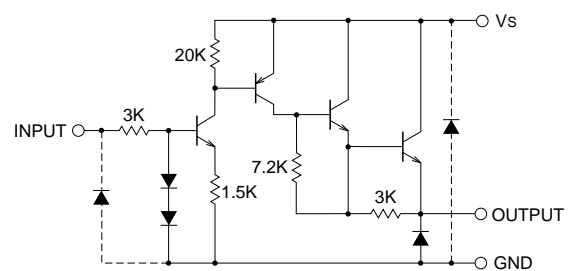

The eight circuits share the  $V_s$  and GND.

The diode, indicated with the dotted line, is parasitic, and cannot be used.

Unit :  $\Omega$

**M54563P/FP**

8-UNIT 500mA SOURCE TYPE DARLINGTON TRANSISTOR ARRAY WITH CLAMP DIODE

**ABSOLUTE MAXIMUM RATINGS** (Unless otherwise noted, Ta = -20 ~ +75°C)

Symbol	Parameter	Conditions	Ratings	Unit
V <sub>CEO</sub> #	Collector-emitter voltage	Output, L	-0.5 ~ +50	V
V <sub>S</sub>	Supply voltage		50	V
V <sub>I</sub>	Input voltage		-0.5 ~ +10	V
I <sub>O</sub>	Output current	Current per circuit output, H	-500	mA
I <sub>F</sub>	Clamping diode forward current		-500	mA
V <sub>R</sub> #	Clamping diode reverse voltage		50	V
P <sub>d</sub>	Power dissipation	Ta = 25°C, when mounted on board	1.79(P)/1.10(FP)	W
T <sub>opr</sub>	Operating temperature		-20 ~ +75	°C
T <sub>stg</sub>	Storage temperature		-55 ~ +125	°C

# : Unused I/O pins must be connected to GND.

**RECOMMENDED OPERATING CONDITIONS** (Unless otherwise noted, Ta = -20 ~ +75°C)

Symbol	Parameter	Limits			Unit	
		min	typ	max		
V <sub>S</sub>	Supply voltage	0	—	50	V	
I <sub>O</sub>	Output current (Current per 1 circuit when 8 circuits are coming on simultaneously)	Duty Cycle P : no more than 8% FP : no more than 5%	0	—	-350	mA
		Duty Cycle P : no more than 55% FP : no more than 30%	0	—	-100	
V <sub>IH</sub>	"H" input voltage	2.4	—	10	V	
V <sub>IL</sub>	"L" input voltage	0	—	0.2	V	

**ELECTRICAL CHARACTERISTICS** (Unless otherwise noted, Ta = -20 ~ +75°C)

Symbol	Parameter	Test conditions	Limits			Unit
			min	typ*	max	
I <sub>S (leak)</sub> #	Supply leak current	V <sub>S</sub> = 50V, V <sub>I</sub> = 0.2V	—	—	100	μA
V <sub>CE (sat)</sub>	Collector-emitter saturation voltage	V <sub>S</sub> = 10V, V <sub>I</sub> = 2.4V, I <sub>O</sub> = -350mA	—	1.6	2.4	V
		V <sub>S</sub> = 10V, V <sub>I</sub> = 2.4V, I <sub>O</sub> = -100mA	—	1.45	2.0	
I <sub>I</sub>	Input current	V <sub>I</sub> = 3V	—	0.6	1.0	mA
		V <sub>I</sub> = 10V	—	2.9	5.0	
I <sub>S</sub>	Supply current	V <sub>S</sub> = 50V, V <sub>I</sub> = 3V (all input)	—	5.6	15.0	mA
V <sub>F</sub>	Clamping diode forward voltage	I <sub>F</sub> = -350mA	—	-1.2	-2.4	V
I <sub>R</sub> #	Clamping diode reverse current	V <sub>R</sub> = 50V	—	—	100	μA

\* : The typical values are those measured under ambient temperature (Ta) of 25°C. There is no guarantee that these values are obtained under any conditions.

# : Unused I/O pins must be connected to GND.

**SWITCHING CHARACTERISTICS** (Unless otherwise noted, Ta = 25°C)

Symbol	Parameter	Test conditions	Limits			Unit
			min	typ	max	
t <sub>on</sub>	Turn-on time	C <sub>L</sub> = 15pF (note 1)	—	100	—	ns
t <sub>off</sub>	Turn-off time		—	4800	—	ns

# M54563P/FP

## 8-UNIT 500mA SOURCE TYPE DARLINGTON TRANSISTOR ARRAY WITH CLAMP DIODE

### NOTE 1 TEST CIRCUIT

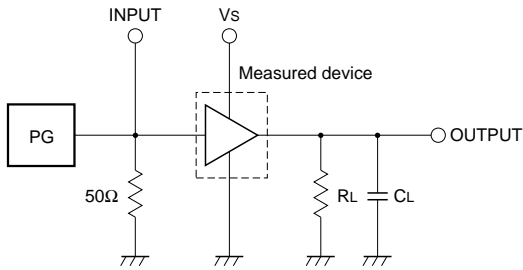

- (1) Pulse generator (PG) characteristics : PRR = 1kHz,  
 $t_w = 10\mu s$ ,  $t_r = 6ns$ ,  $t_f = 6ns$ ,  $Z_o = 50\Omega$   
 $V_i = 0$  to  $2.4V$
- (2) Input-output conditions :  $R_L = 30\Omega$ ,  $V_s = 10V$
- (3) Electrostatic capacity  $C_L$  includes floating capacitance at connections and input capacitance at probes

### TIMING DIAGRAM

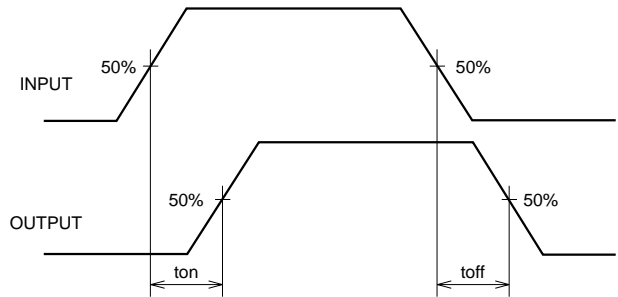

### TYPICAL CHARACTERISTICS

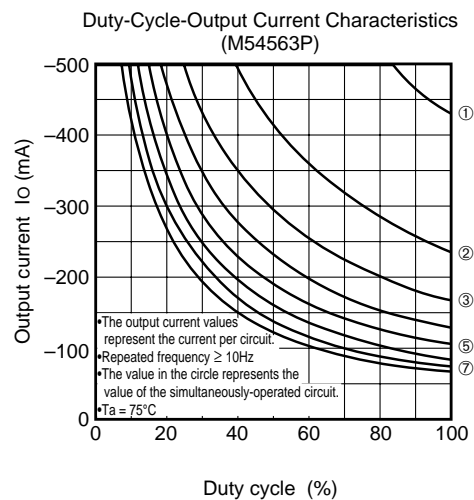
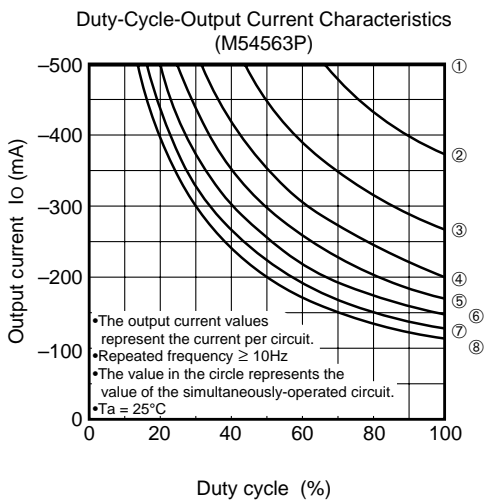
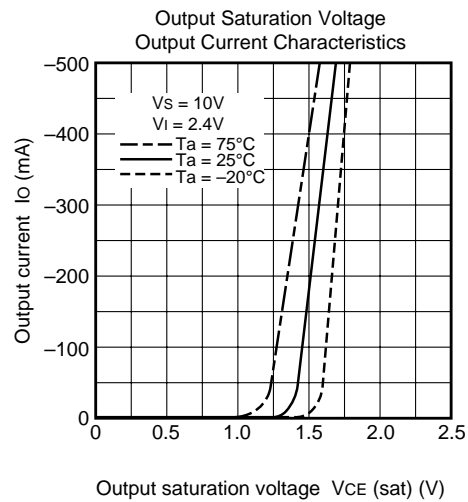
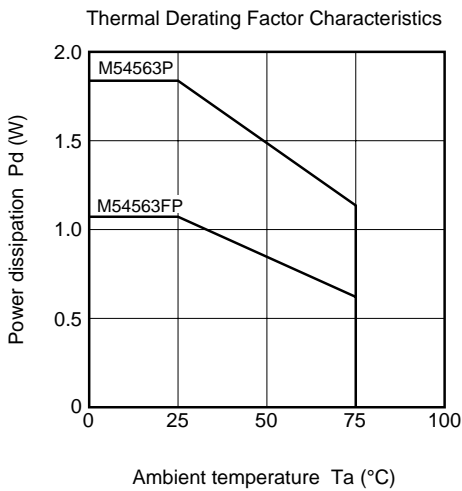

M54563P/FP

8-UNIT 500mA SOURCE TYPE DARLINGTON TRANSISTOR ARRAY WITH CLAMP DIODE

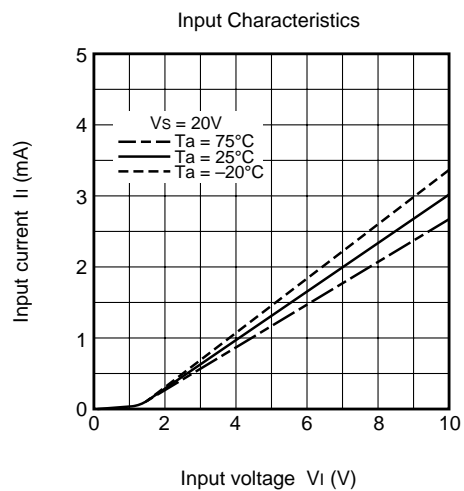
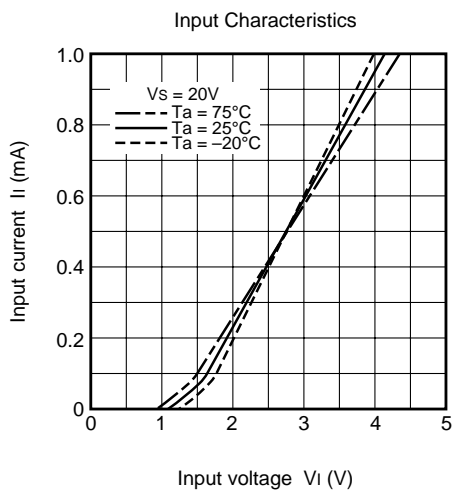
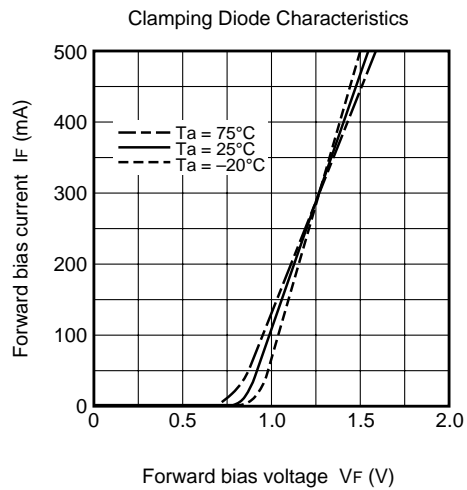
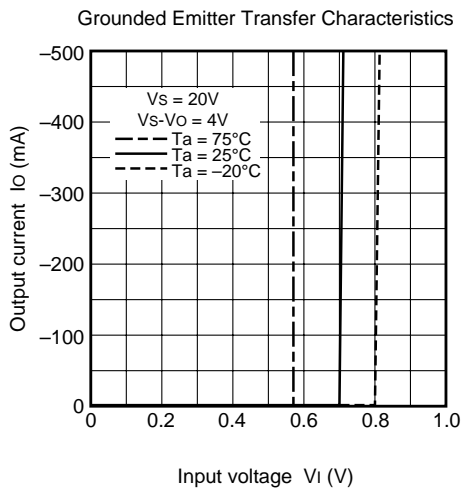
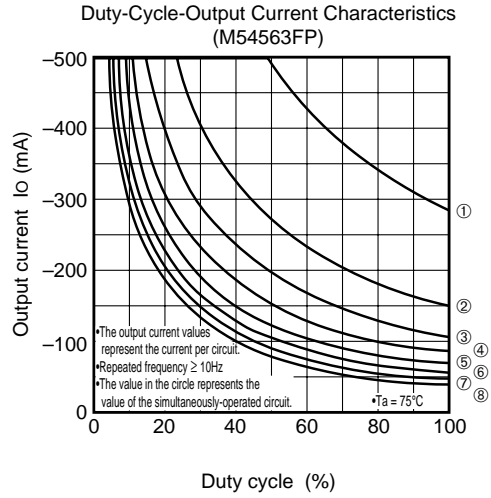
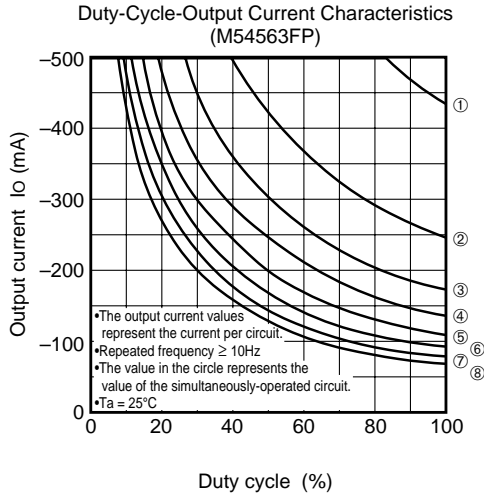

This datasheet has been download from:

[www.datasheetcatalog.com](http://www.datasheetcatalog.com)

Datasheets for electronics components.