

# MA3810

## OUTLINE DIMENSIONS

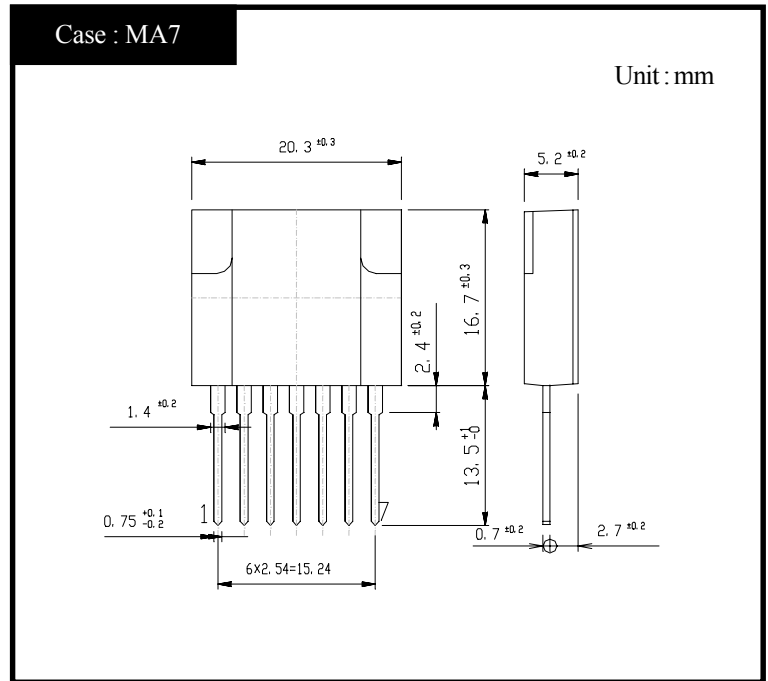

## RATINGS

### Absolute Maximum Ratings

Item	Symbol	Conditions	Ratings	Unit
Storage Temperature	T <sub>stg</sub>		-30~125	°C
Operating Temperature	T <sub>op</sub>		-20~125	°C
Junction Temperature	T <sub>j</sub>		150	°C
Peak Input Voltage	V <sub>in</sub>	②+,④-,Fig.1 is Measurement Circuit of Peak Input Voltage V <sub>in</sub> and Collector Cutoff Current I <sub>CEX</sub> .	850	V
Input Current	I <sub>in</sub>	DC ②+,④- Pulse ②+,④- Pulse Width 150 μs MAX, Duty 1/2, Sawtooth Wave, Peak Value.	2 4	A
Maximum Power Dissipation	P <sub>D</sub>	T <sub>a</sub> =25°C	3	W
	P <sub>D</sub>	Heatsink T <sub>c</sub> =100°C	14	W
Dielectric Strength	V <sub>dis</sub>	Terminals To Case AC 1 min	2	kV
Insulation Resistance		Terminals To Case 500VDC	100	MΩ
Max Voltage ④ to ⑦	V <sub>④·⑦</sub>	④+,⑦-	6	V
Max Current ⑥ to ④	I <sub>⑥·④</sub>	⑥+,④- (Peak) Duty Max 3/5	100	mA
Max Current ⑤ to ④	I <sub>⑤·④</sub>	⑤+,④- (Q <sub>2</sub> Collector Current)	500	mA

### Electrical Characteristics (T<sub>c</sub>=25°C)

Item	Symbol	Conditions	Ratings	Unit	
Q1	Collector Cutoff Current	I <sub>CEX</sub>	V <sub>CE</sub> =850V, Fig.1 is Measurement Circuit of Peak Input Voltage V <sub>in</sub> and Collector Cutoff Current I <sub>CEX</sub> . , ②+,④-	MAX 100	μA
	DC Current Gain	h <sub>FE</sub>	V <sub>CE</sub> = 5V, I <sub>C</sub> = 1.0A, ②+,④-,⑤I <sub>B</sub>	11~22	
	Collector to Emitter Saturation Voltage	V <sub>CE(sat)</sub>	I <sub>C</sub> =1.0A, I <sub>B</sub> =0.2A, ②+,④-,⑤I <sub>B</sub>	MAX 1.0 MIN 1.7	V
	Driving Saturation Voltage	V <sub>D(sat)</sub>	I <sub>C</sub> =1.5A, I <sub>B</sub> =0.2A, ②+,④-,⑤I <sub>B</sub>	MAX 2.3	V
	Thermal Resistance	θ <sub>jc</sub>	Junction to Case	MAX 3.5	°C/W

●Standard Operating Condition • Design Standard For Application Circuit

Item	Conditions	Ratings	Unit
Input Rated Voltage		AC175~276	V
Output Nominal Wattage		40	W
Output Nominal Voltage		12	V
Output Nominal Current		3.3	A

●Standard Operating Condition • Standard Operating Characteristics (Ta=25°C)

Item	Conditions	Ratings	Unit		
AC Input Voltage	$I_O=3.3A, 10.5V \leq V_O \leq 12.6V$	MAX 175	V		
Minimum Input Full Load Output Voltage	$V_{in}=180V, I_O=3.3A$	$12.0 \pm 0.6$	V	Fig 2, ① Refer	
Maximum Input Light Load Output Voltage	$V_{in}=276V, I_O=0.0A$	$12.0 \pm 0.6$	V	Fig 2, ② Refer	
Over Current Protection	Foldback Current	$V_{in}=276V, V_O=10V$	MAX 5.3	A	Fig 2, ③ Refer
	Short Circuit	$V_{in}=276V, R_O=0.5 \Omega$	Nodamage To Any Device, Automatic Recovery.	-	Fig 2, ④ Refer

Figure in ○=Terminal Sign

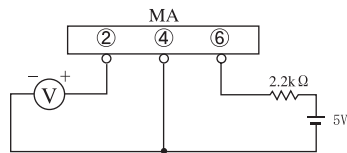

Fig1. Measurement Circuit

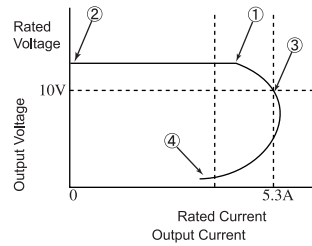
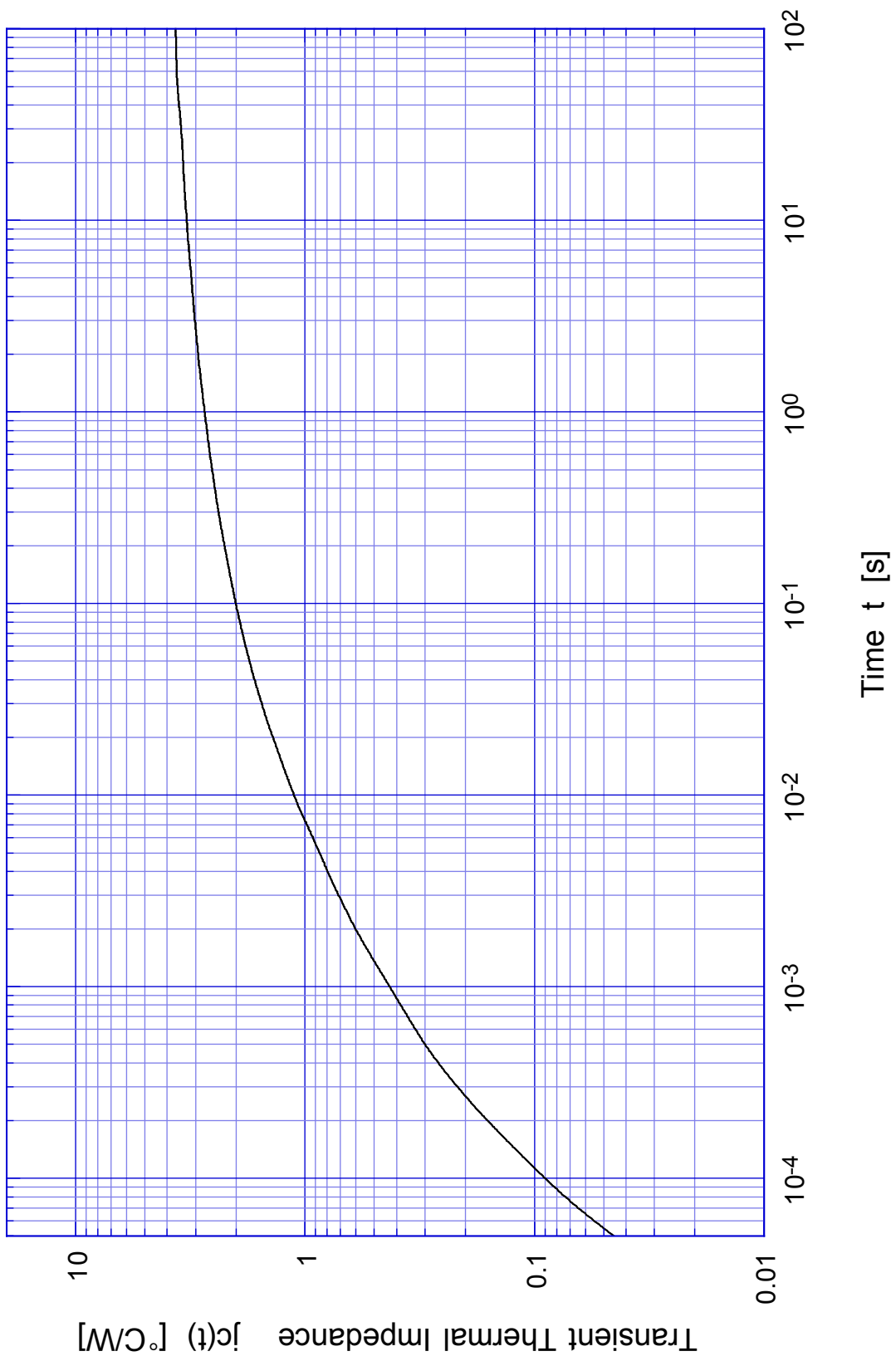

Fig2. Output Voltage/Current

# MA3810 Transient Thermal Impedance



MA3810

Forward Bias SOA

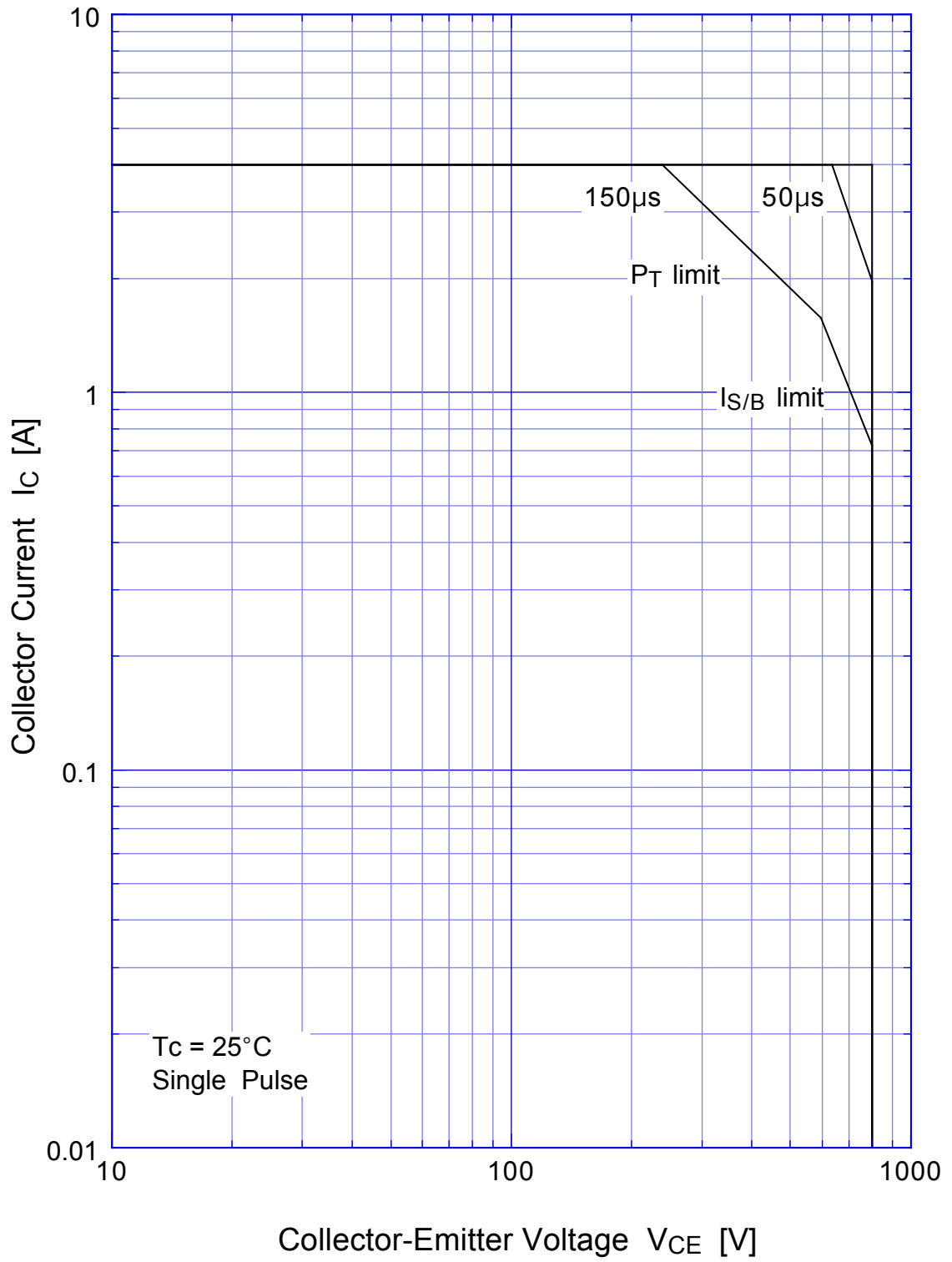

# MA3810

## Collector Current Derating

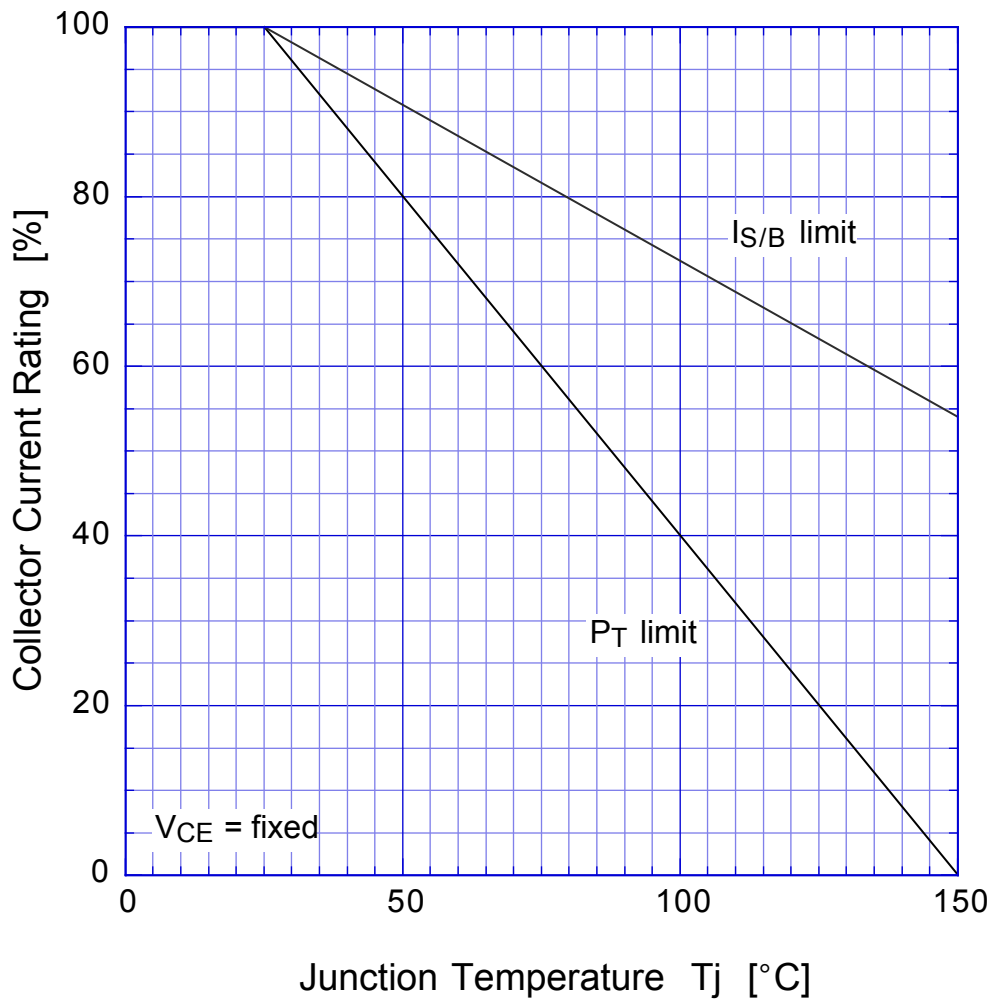

MA3810

Reverse Bias SOA

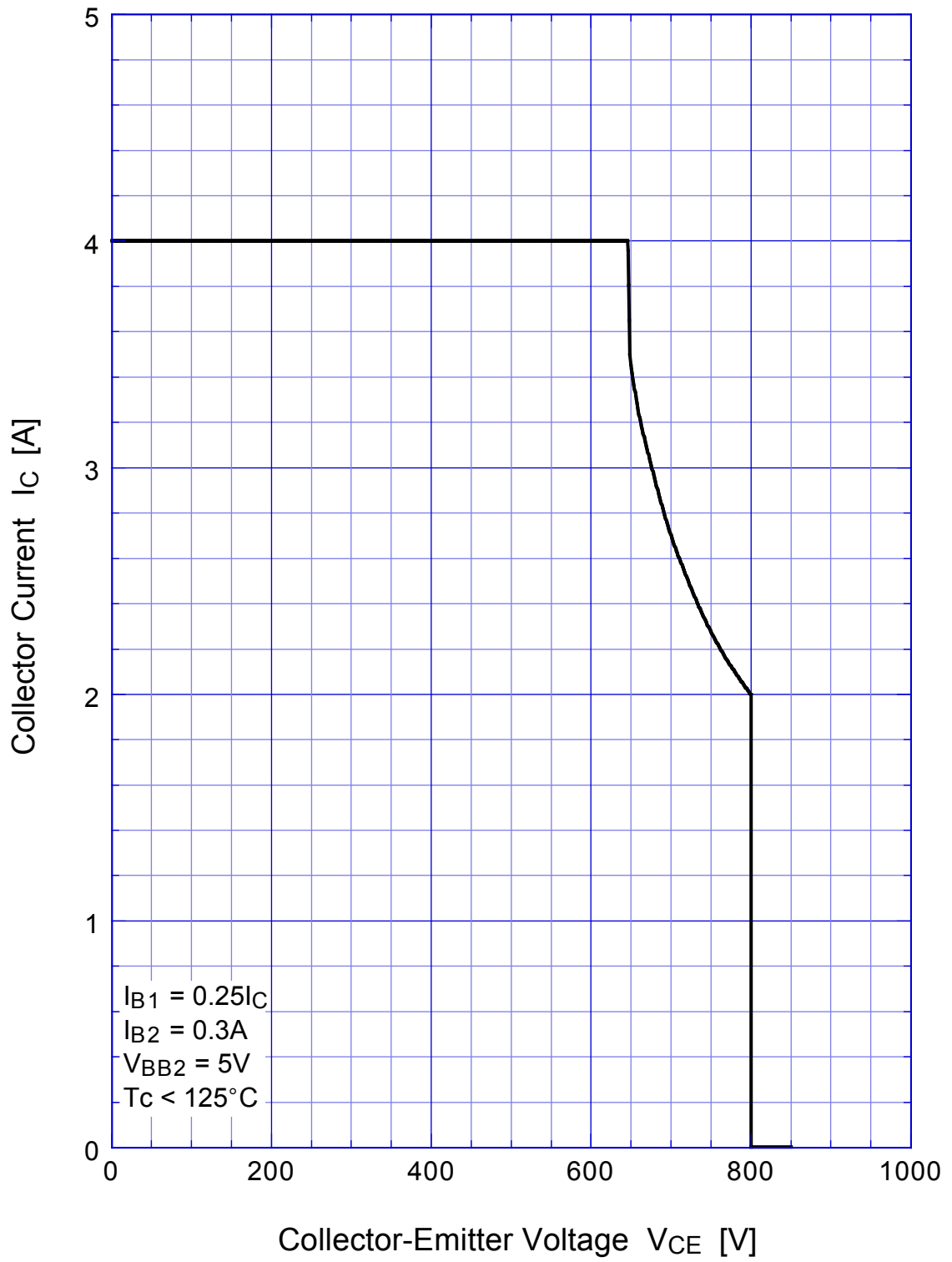

# MA3810

## $h_{FE} - I_C$

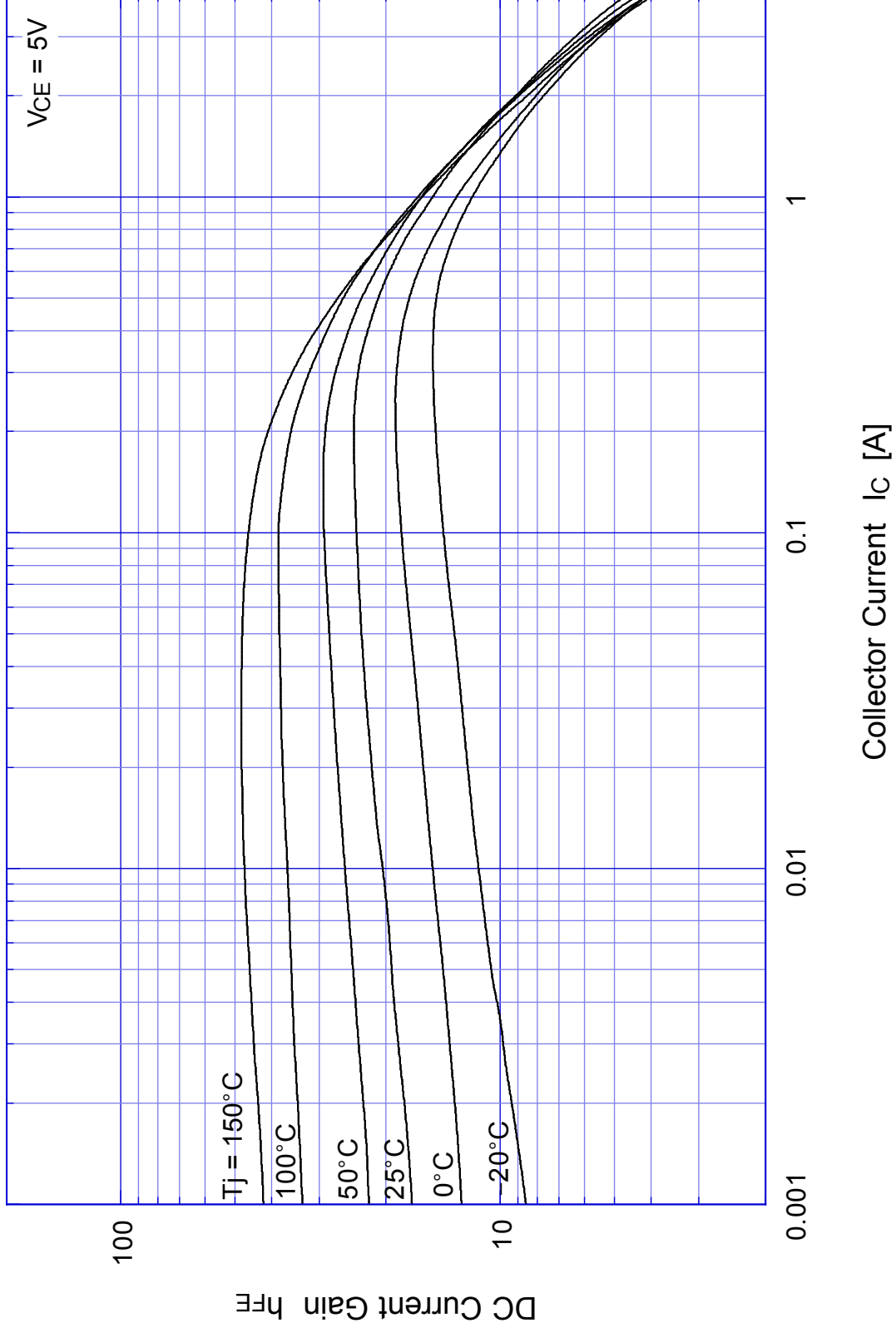

This datasheet has been download from:

[www.datasheetcatalog.com](http://www.datasheetcatalog.com)

Datasheets for electronics components.