

Dual N-Channel 60-V (D-S) MOSFET

GENERAL DESCRIPTION

The ME4946 is the Dual N-Channel logic enhancement mode power field effect transistors are produced using high cell density, DMOS trench technology. This high density process is especially tailored to minimize on-state resistance. These devices are particularly suited for low voltage application such as cellular phone and notebook computer power management and other battery powered circuits where high-side switching and low in-line power loss are needed in a very small outline surface mount package.

FEATURES

- $R_{DS(ON)} \leq 41m\Omega @ V_{GS}=10V$
- $R_{DS(ON)} \leq 52m\Omega @ V_{GS}=4.5V$
- Super high density cell design for extremely low $R_{DS(ON)}$
- Exceptional on-resistance and maximum DC current capability

APPLICATIONS

- Power Management
- DC/DC Converter
- LCD TV & Monitor Display inverter
- CCFL inverter

PIN CONFIGURATION

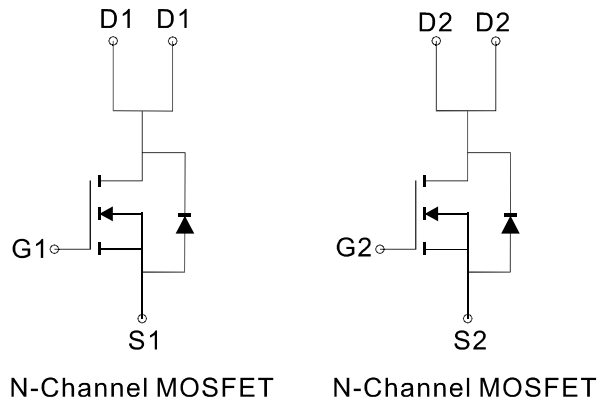
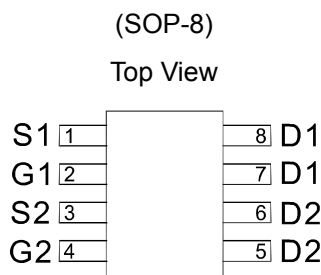

Absolute Maximum Ratings (TA=25°C Unless Otherwise Noted)

Parameter	Symbol	10 secs	Steady State	Unit
Drain-Source Voltage	V_{DSS}	60		V
Gate-Source Voltage	V_{GSS}	± 20		
Continuous Drain Current (Tj=150°C)	I_D	6.4	5	A
		5.1	4	
Pulsed Drain Current	I_{DM}	30		
Continuous Source-Drain Diode Current	I_S	2		
Avalanche Current	I_{AS}	15		mJ
Single-Pulse Avalanche Energy	E_{AS}	12		
Maximum Power Dissipation	P_D	2.7	1.6	W
		1.7	1	
Operating Junction & Storage Temperature Range	T_J	-55 to 150		°C
Thermal Resistance-Junction to Ambient *	$R_{\theta JA}$	46	76	°C/W
Thermal Resistance-Junction to Case *	$R_{\theta JC}$	43		

*The device mounted on 1in² FR4 board with 2 oz copper

Dual N-Channel 60-V (D-S) MOSFET

Electrical Characteristics (T_A = 25°C Unless Otherwise Specified)

Symbol	Parameter	Conditions	Min	Typ	Max	Unit
STATIC						
V _{DS}	Drain-Source Breakdown Voltage	V _{GS} =0V, I _D =250 μA	60			V
V _{GS(th)}	Gate Threshold Voltage	V _{DS} =V _{GS} , I _D =250 μA	1.0	1.8	3.0	V
I _{GSS}	Gate Leakage Current	V _{DS} =0V, V _{GS} =±20V			±100	nA
I _{DSS}	Zero Gate Voltage Drain Current	V _{DS} =60V, V _{GS} =0V			1	μA
		V _{DS} =60V, V _{GS} =0V			10	
		T _J =55°C				
R _{DS(ON)}	Drain-Source On-Resistance ^a	V _{GS} =10V, I _D = 5.3A		33	41	mΩ
		V _{GS} =4.5V, I _D = 4.7A		40	52	
V _{SD}	Diode Forward Voltage	I _S =2A		0.8	1.2	V
DYNAMIC						
C _{iss}	Input capacitance	V _{DS} =30V, V _{GS} =0V, f=1.0MHz		940	1100	pF
C _{oss}	Output Capacitance			71		
C _{rss}	Reverse Transfer Capacitance			33		
Q _g	Total Gate Charge	V _{DS} =30V, V _{GS} =10V, I _D =5.3A		22	29	nC
				13.3	18	
Q _{gs}	Gate-Source Charge	V _{DS} =30V, V _{GS} =5V, I _D =5.3A		7.1		
Q _{gd}	Gate-Drain Charge			7.5		
R _g	Gate Resistance	f=1MHz		0.9		Ω
t _{d(on)}	Turn-On Delay Time	V _{DD} =30V, R _L =6.8Ω I _D =4.4A, V _{GEN} =10V R _G =1Ω		14	18	ns
t _r	Turn-On Rise Time			26	33	
t _{d(off)}	Turn-Off Delay Time			41	52	
t _f	Turn-Off Fall Time			3.6	6	
t _{d(on)}	Turn-On Delay Time	V _{DD} =30V, R _L =6.8Ω I _D =4.4A, V _{GEN} =4.5V R _G =1Ω		12	16	
t _r	Turn-On Rise Time			26	33	
t _{d(off)}	Turn-Off Delay Time			42	52	
t _f	Turn-Off Fall Time			3.8	7	

Notes: a. Pulse test; pulse width ≤ 300us, duty cycle ≤ 2%

Typical Characteristics (T_J = 25°C Noted)

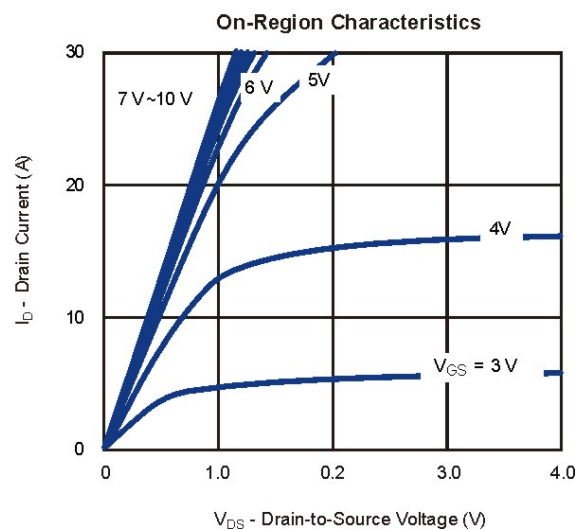
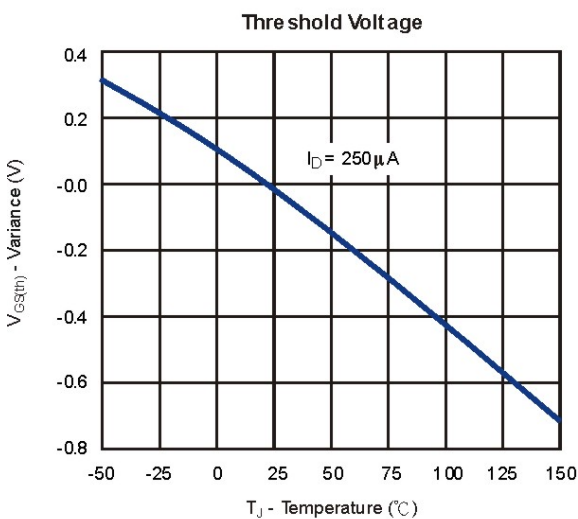
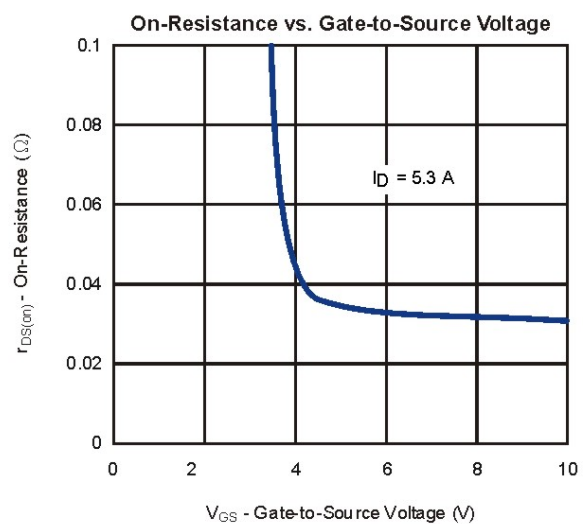
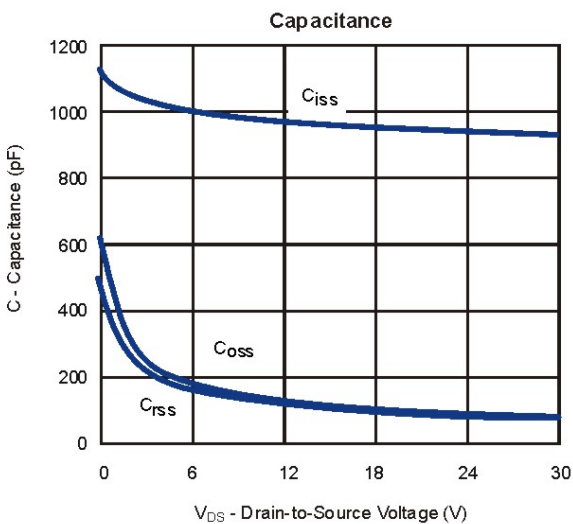
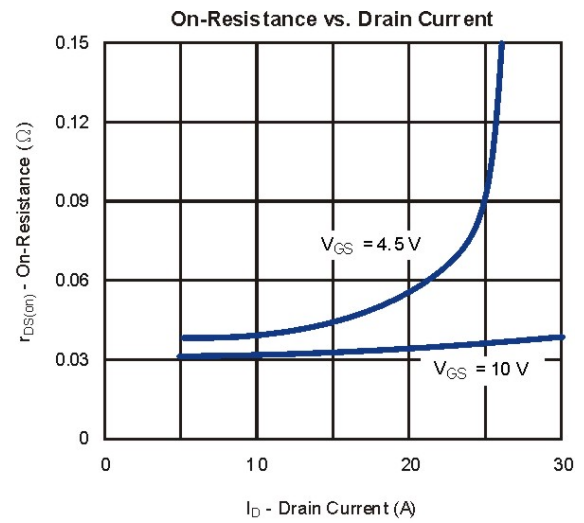
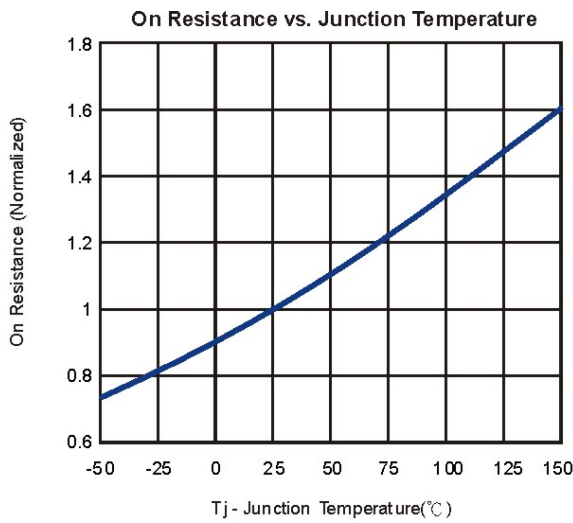

Typical Characteristics (T_J = 25°C Noted)

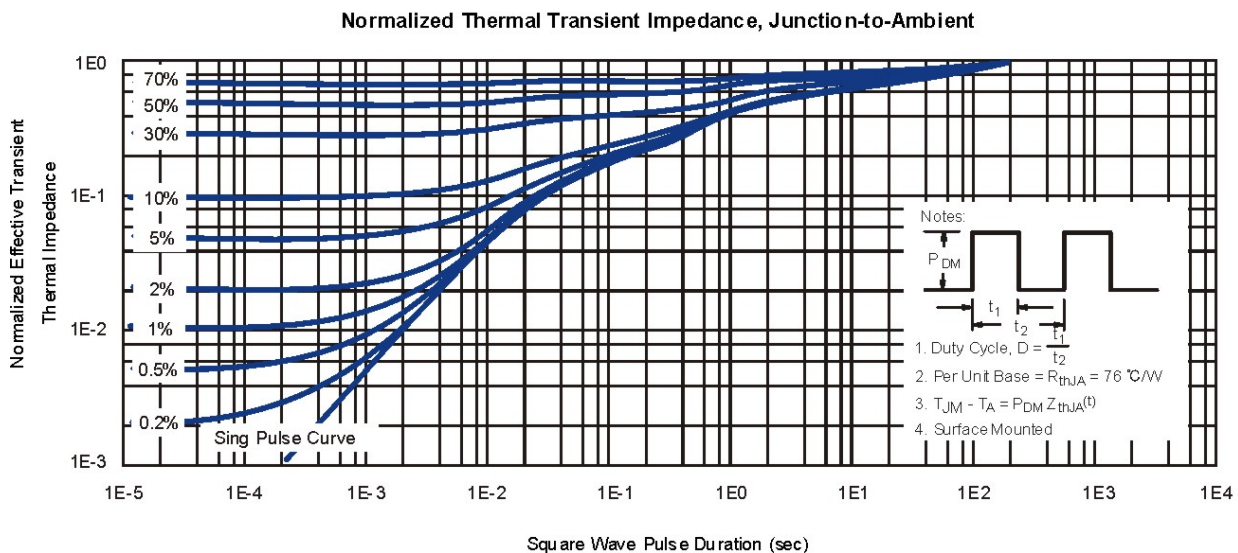
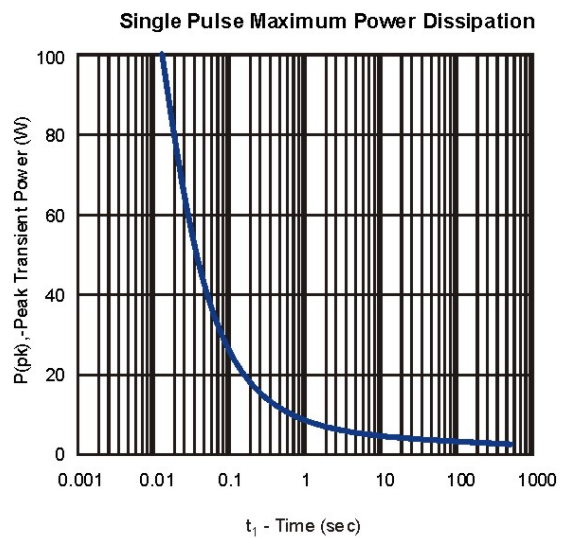
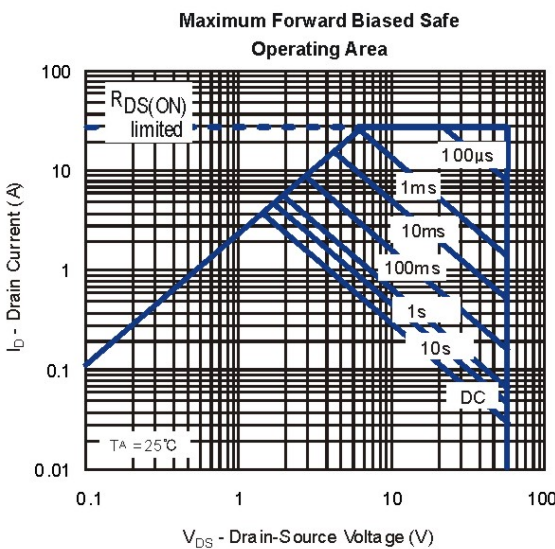
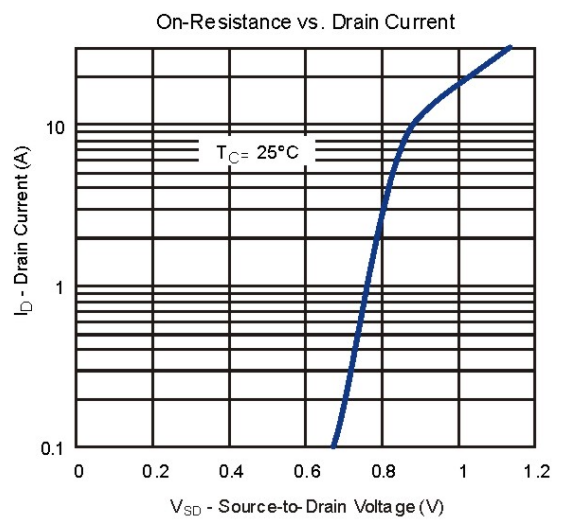
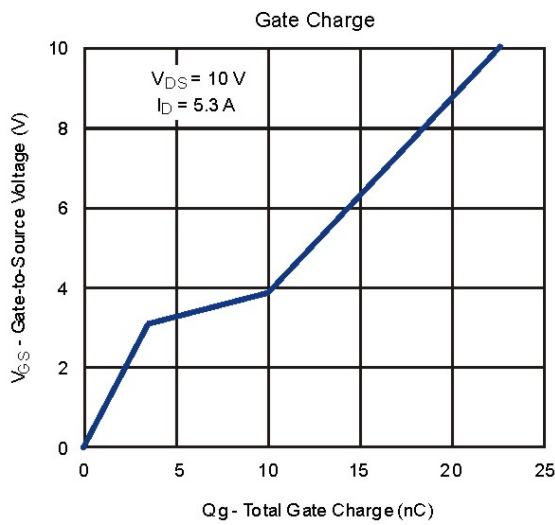

SOP-8 Package Outline

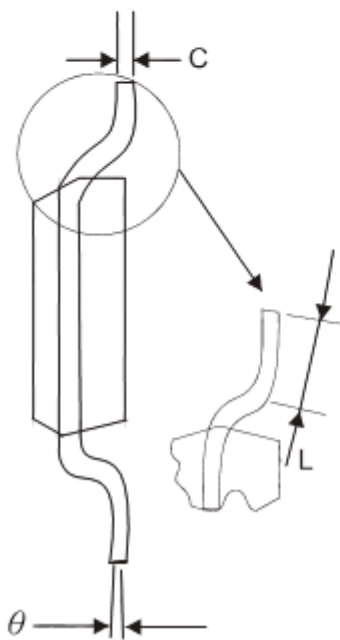
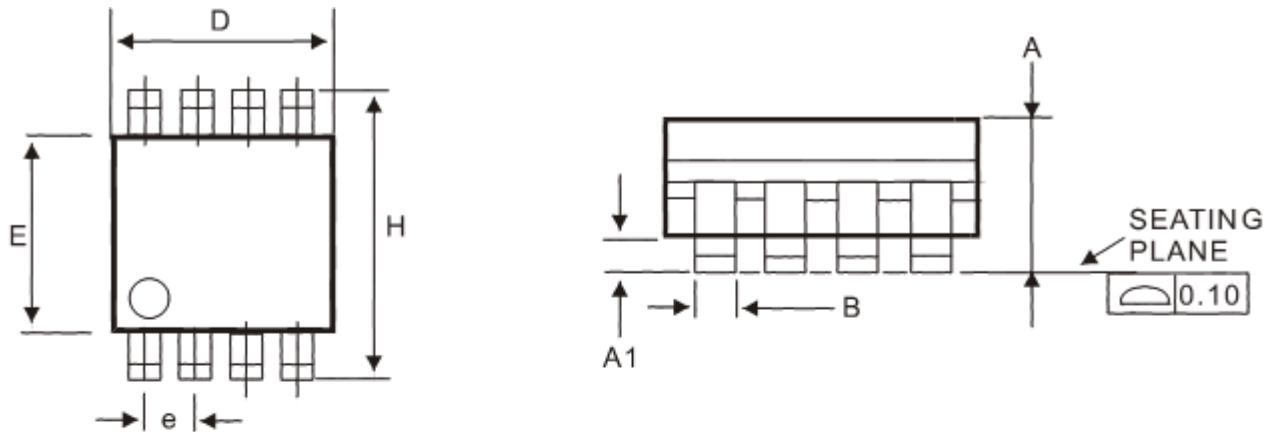

DIM	MILLIMETERS (mm)	
	MIN	MAX
A	1.35	1.75
A1	0.10	0.25
B	0.35	0.49
C	0.18	0.25
D	4.80	5.00
E	3.80	4.00
e	1.27 BSC	
H	5.80	6.20
L	0.40	1.25
θ	0°	7°

Note: 1. Refer to JEDEC MS-012AA.

2. Dimension "D" does not include mold flash, protrusions or gate burrs . Mold flash, protrusions or gate burrs shall not exceed 0.15 mm per side.