

# MTW8N60E

Preferred Device

## Power MOSFET 8 Amps, 600 Volts N-Channel TO-247

This high voltage MOSFET uses an advanced termination scheme to provide enhanced voltage-blocking capability without degrading performance over time. In addition, this advanced Power MOSFET is designed to withstand high energy in the avalanche and commutation modes. The new energy efficient design also offers a drain-to-source diode with a fast recovery time. Designed for high voltage, high speed switching applications in power supplies, converters and PWM motor controls, these devices are particularly well suited for bridge circuits where diode speed and commutating safe operating areas are critical and offer additional safety margin against unexpected voltage transients.

- Robust High Voltage Termination
- Avalanche Energy Specified
- Source-to-Drain Diode Recovery Time Comparable to a Discrete Fast Recovery Diode
- Diode is Characterized for Use in Bridge Circuits
- $I_{DSS}$  and  $V_{DS(on)}$  Specified at Elevated Temperature
- Isolated Mounting Hole Reduces Mounting Hardware

### MAXIMUM RATINGS ( $T_C = 25^\circ\text{C}$ unless otherwise noted)

Rating	Symbol	Value	Unit
Drain-Source Voltage	$V_{DSS}$	600	Vdc
Drain-Gate Voltage ( $R_{GS} = 1.0\text{ M}\Omega$ )	$V_{DGR}$	600	Vdc
Gate-Source Voltage	$V_{GS}$	$\pm 20$	Vdc
– Continuous	$V_{GSM}$	$\pm 40$	Vpk
– Non-Repetitive ( $t_p \leq 10\text{ ms}$ )			
Drain Current – Continuous	$I_D$	8.0	Adc
– Continuous @ $100^\circ\text{C}$	$I_D$	6.4	
– Single Pulse ( $t_p \leq 10\ \mu\text{s}$ )	$I_{DM}$	24	Apk
Total Power Dissipation	$P_D$	180	Watts
Derate above $25^\circ\text{C}$		1.43	W/ $^\circ\text{C}$
Operating and Storage Temperature Range	$T_J, T_{stg}$	$-55$ to $150$	$^\circ\text{C}$
Single Pulse Drain-to-Source Avalanche Energy – Starting $T_J = 25^\circ\text{C}$ ( $V_{DD} = 100\text{ Vdc}$ , $V_{GS} = 10\text{ Vdc}$ , $I_L = 24\text{ Apk}$ , $L = 3.0\text{ mH}$ , $R_G = 25\ \Omega$ )	$E_{AS}$	864	mJ
Thermal Resistance – Junction to Case	$R_{\theta JC}$	0.70	$^\circ\text{C/W}$
– Junction to Ambient	$R_{\theta JA}$	40	
Maximum Lead Temperature for Soldering Purposes, $1/8''$ from case for 10 seconds	$T_L$	260	$^\circ\text{C}$



ON Semiconductor

<http://onsemi.com>

**8 AMPERES**  
**600 VOLTS**  
 $R_{DS(on)} = 550\text{ m}\Omega$

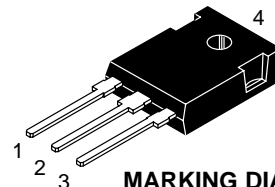
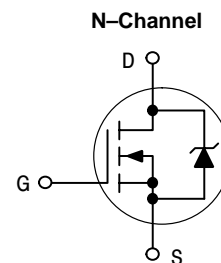

TO-247AE  
CASE 340K  
Style 1

### MARKING DIAGRAM & PIN ASSIGNMENT

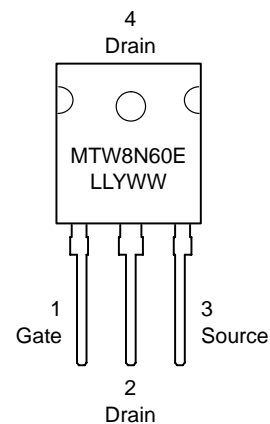

LL = Location Code  
Y = Year  
WW = Work Week

### ORDERING INFORMATION

Device	Package	Shipping
MTW8N60E	TO-247	30 Units/Rail

Preferred devices are recommended choices for future use and best overall value.

# MTW8N60E

## ELECTRICAL CHARACTERISTICS (T<sub>J</sub> = 25°C unless otherwise noted)

Characteristic	Symbol	Min	Typ	Max	Unit
<b>OFF CHARACTERISTICS</b>					
Drain–Source Breakdown Voltage (V <sub>GS</sub> = 0 Vdc, I <sub>D</sub> = 250 μAdc) Temperature Coefficient (Positive)	V <sub>(BR)DSS</sub>	600 –	– 695	– –	Vdc mV/°C
Zero Gate Voltage Drain Current (V <sub>DS</sub> = 600 Vdc, V <sub>GS</sub> = 0 Vdc) (V <sub>DS</sub> = 600 Vdc, V <sub>GS</sub> = 0 Vdc, T <sub>J</sub> = 125°C)	I <sub>DSS</sub>	– –	– –	10 100	μAdc
Gate–Body Leakage Current (V <sub>GS</sub> = ± 20 Vdc, V <sub>DS</sub> = 0)	I <sub>GSS</sub>	–	–	100	nAdc

## ON CHARACTERISTICS (Note 1.)

Gate Threshold Voltage (V <sub>DS</sub> = V <sub>GS</sub> , I <sub>D</sub> = 250 μAdc) Temperature Coefficient (Negative)	V <sub>GS(th)</sub>	2.0 –	3.0 7.0	4.0 –	Vdc mV/°C
Static Drain–Source On–Resistance (V <sub>GS</sub> = 10 Vdc, I <sub>D</sub> = 4.0 Adc)	R <sub>DS(on)</sub>	–	0.46	0.55	Ohm
Drain–Source On–Voltage (V <sub>GS</sub> = 10 Vdc) (I <sub>D</sub> = 8.0 Adc) (I <sub>D</sub> = 4.0 Adc, T <sub>J</sub> = 125°C)	V <sub>DS(on)</sub>	– –	3.2 –	4.8 4.6	Vdc
Forward Transconductance (V <sub>DS</sub> = 15 Vdc, I <sub>D</sub> = 4.0 Adc)	g <sub>FS</sub>	4.0	8.5	–	mhos

## DYNAMIC CHARACTERISTICS

Input Capacitance	(V <sub>DS</sub> = 25 Vdc, V <sub>GS</sub> = 0 Vdc, f = 1.0 MHz)	C <sub>iss</sub>	–	2480	3470	pF
Output Capacitance		C <sub>oss</sub>	–	247	346	
Reverse Transfer Capacitance		C <sub>rss</sub>	–	56	120	

## SWITCHING CHARACTERISTICS (Note 2.)

Turn–On Delay Time	(V <sub>DD</sub> = 300 Vdc, I <sub>D</sub> = 8.0 Adc, V <sub>GS</sub> = 10 Vdc, R <sub>G</sub> = 9.1 Ω)	t <sub>d(on)</sub>	–	23.6	50	ns
Rise Time		t <sub>r</sub>	–	37.6	70	
Turn–Off Delay Time		t <sub>d(off)</sub>	–	80	170	
Fall Time		t <sub>f</sub>	–	48	95	
Gate Charge (See Figure 8)	(V <sub>DS</sub> = 300 Vdc, I <sub>D</sub> = 8.0 Adc, V <sub>GS</sub> = 10 Vdc)	Q <sub>T</sub>	–	67	100	nC
		Q <sub>1</sub>	–	17	–	
		Q <sub>2</sub>	–	26	–	
		Q <sub>3</sub>	–	27	–	

## SOURCE–DRAIN DIODE CHARACTERISTICS

Forward On–Voltage (Note 1.)	(I <sub>S</sub> = 8.0 Adc, V <sub>GS</sub> = 0 Vdc) (I <sub>S</sub> = 8.0 Adc, V <sub>GS</sub> = 0 Vdc, T <sub>J</sub> = 125°C)	V <sub>SD</sub>	– –	0.829 0.71	1.1 –	Vdc
Reverse Recovery Time (See Figure 14)	(I <sub>S</sub> = 8.0 Adc, V <sub>GS</sub> = 0 Vdc, di <sub>S</sub> /dt = 100 A/μs)	t <sub>rr</sub>	–	381	–	ns
		t <sub>a</sub>	–	225	–	
		t <sub>b</sub>	–	156	–	
Reverse Recovery Stored Charge		Q <sub>RR</sub>	–	4.61	–	μC

## INTERNAL PACKAGE INDUCTANCE

Internal Drain Inductance (Measured from the drain lead 0.25" from package to center of die)	L <sub>D</sub>	–	4.5	–	nH
Internal Source Inductance (Measured from the source lead 0.25" from package to source bond pad)	L <sub>S</sub>	–	13	–	nH

1. Pulse Test: Pulse Width ≤ 300 μs, Duty Cycle ≤ 2%.
2. Switching characteristics are independent of operating junction temperature.

# MTW8N60E

## TYPICAL ELECTRICAL CHARACTERISTICS

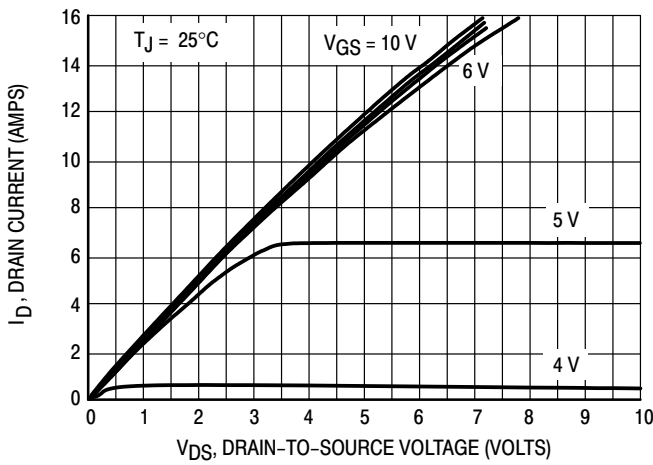

Figure 1. On-Region Characteristics

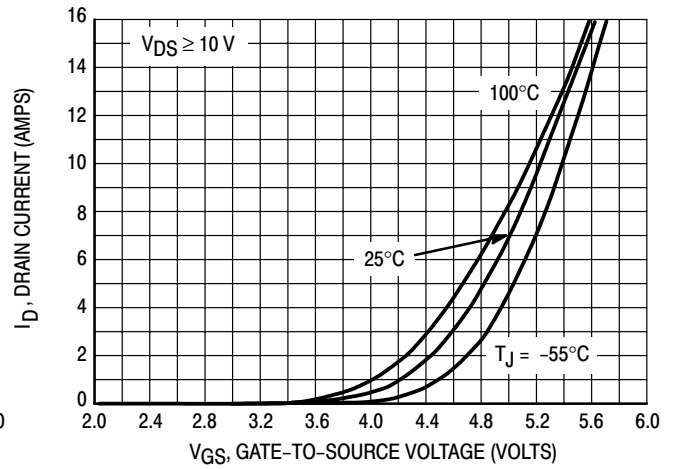

Figure 2. Transfer Characteristics

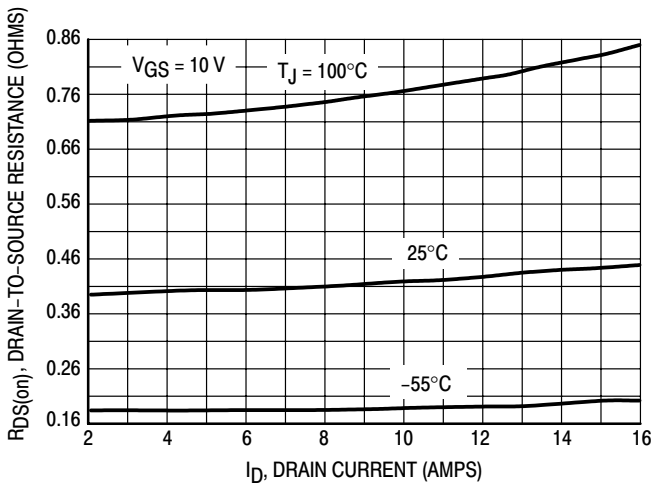

Figure 3. On-Resistance versus Drain Current and Temperature

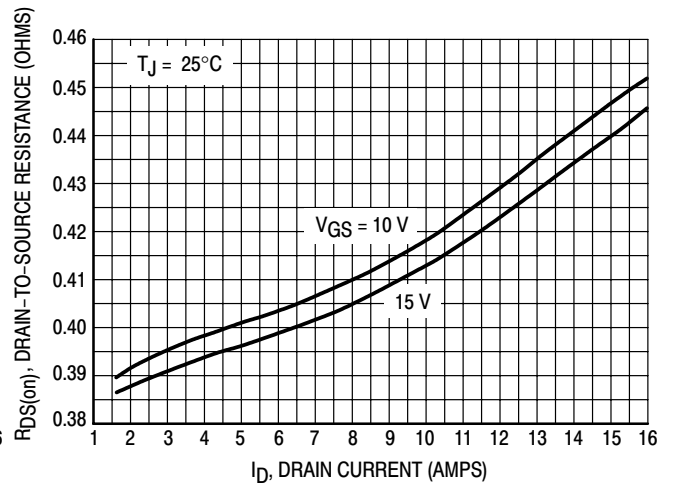

Figure 4. On-Resistance versus Drain Current and Gate Voltage

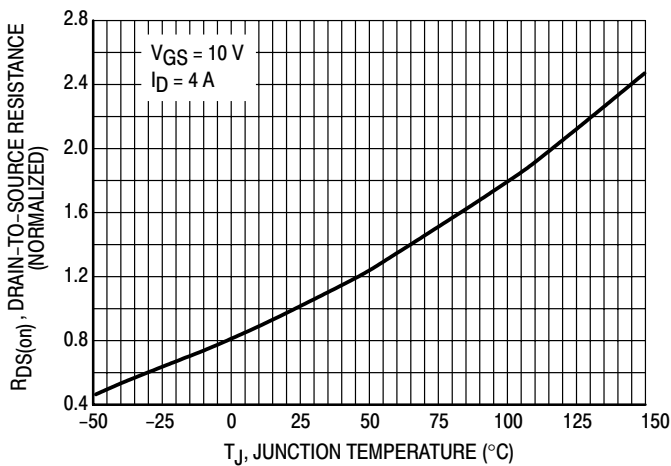

Figure 5. On-Resistance Variation with Temperature

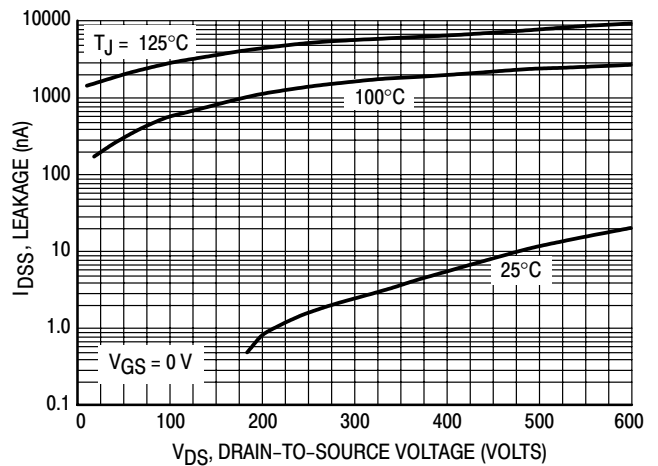

Figure 6. Drain-To-Source Leakage Current versus Voltage

POWER MOSFET SWITCHING

Switching behavior is most easily modeled and predicted by recognizing that the power MOSFET is charge controlled. The lengths of various switching intervals ( $\Delta t$ ) are determined by how fast the FET input capacitance can be charged by current from the generator.

The published capacitance data is difficult to use for calculating rise and fall because drain-gate capacitance varies greatly with applied voltage. Accordingly, gate charge data is used. In most cases, a satisfactory estimate of average input current ( $I_{G(AV)}$ ) can be made from a rudimentary analysis of the drive circuit so that

$$t = Q/I_{G(AV)}$$

During the rise and fall time interval when switching a resistive load,  $V_{GS}$  remains virtually constant at a level known as the plateau voltage,  $V_{SGP}$ . Therefore, rise and fall times may be approximated by the following:

$$t_r = Q_2 \times R_G / (V_{GG} - V_{SGP})$$

$$t_f = Q_2 \times R_G / V_{SGP}$$

where

$V_{GG}$  = the gate drive voltage, which varies from zero to  $V_{GG}$

$R_G$  = the gate drive resistance

and  $Q_2$  and  $V_{SGP}$  are read from the gate charge curve.

During the turn-on and turn-off delay times, gate current is not constant. The simplest calculation uses appropriate values from the capacitance curves in a standard equation for voltage change in an RC network. The equations are:

$$t_{d(on)} = R_G C_{iss} \ln [V_{GG}/(V_{GG} - V_{SGP})]$$

$$t_{d(off)} = R_G C_{iss} \ln (V_{GG}/V_{SGP})$$

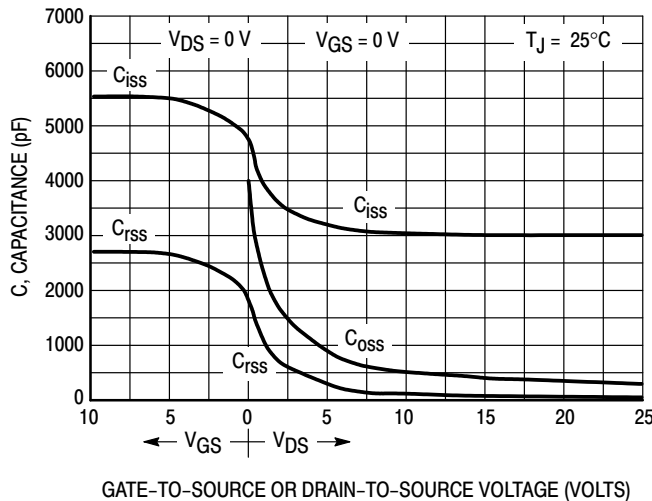

Figure 7a. Capacitance Variation

The capacitance ( $C_{iss}$ ) is read from the capacitance curve at a voltage corresponding to the off-state condition when calculating  $t_{d(on)}$  and is read at a voltage corresponding to the on-state when calculating  $t_{d(off)}$ .

At high switching speeds, parasitic circuit elements complicate the analysis. The inductance of the MOSFET source lead, inside the package and in the circuit wiring which is common to both the drain and gate current paths, produces a voltage at the source which reduces the gate drive current. The voltage is determined by  $L di/dt$ , but since  $di/dt$  is a function of drain current, the mathematical solution is complex. The MOSFET output capacitance also complicates the mathematics. And finally, MOSFETs have finite internal gate resistance which effectively adds to the resistance of the driving source, but the internal resistance is difficult to measure and, consequently, is not specified.

The resistive switching time variation versus gate resistance (Figure 9) shows how typical switching performance is affected by the parasitic circuit elements. If the parasitics were not present, the slope of the curves would maintain a value of unity regardless of the switching speed. The circuit used to obtain the data is constructed to minimize common inductance in the drain and gate circuit loops and is believed readily achievable with board mounted components. Most power electronic loads are inductive; the data in the figure is taken with a resistive load, which approximates an optimally snubbed inductive load. Power MOSFETs may be safely operated into an inductive load; however, snubbing reduces switching losses.

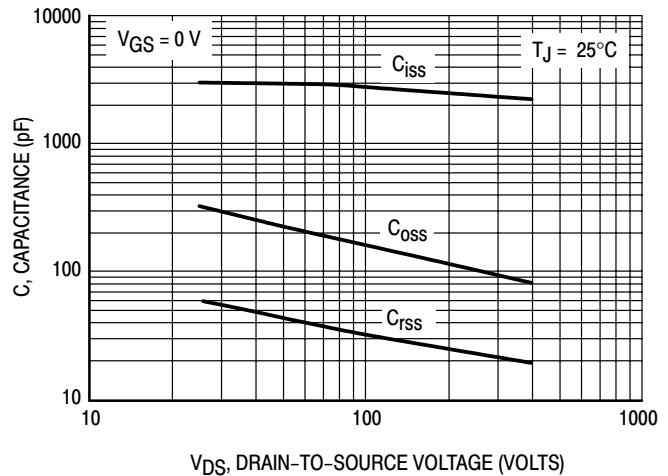

Figure 7b. High Voltage Capacitance Variation

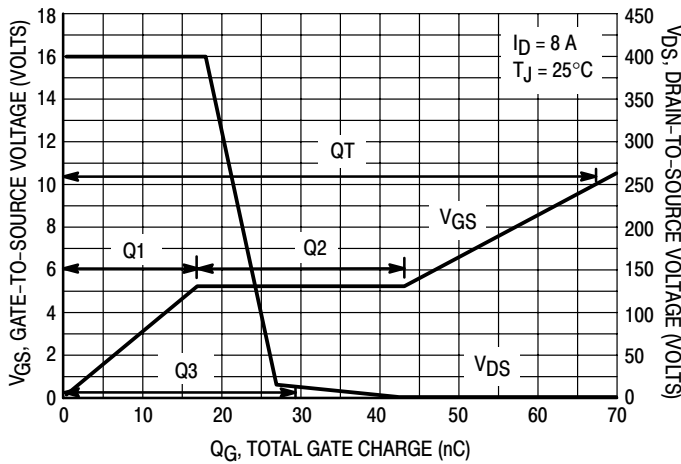

Figure 8. Gate-to-Source and Drain-to-Source Voltage versus Total Charge

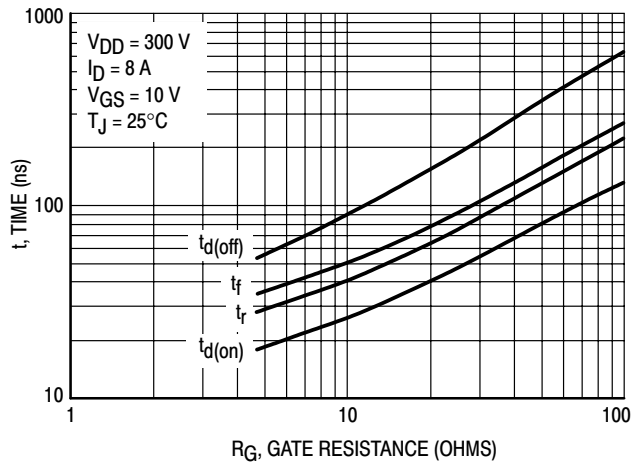

Figure 9. Resistive Switching Time Variation versus Gate Resistance

DRAIN-TO-SOURCE DIODE CHARACTERISTICS

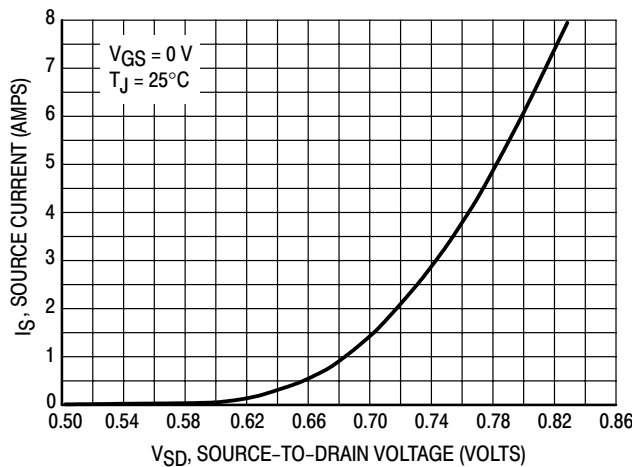

Figure 10. Diode Forward Voltage versus Current

SAFE OPERATING AREA

The Forward Biased Safe Operating Area curves define the maximum simultaneous drain-to-source voltage and drain current that a transistor can handle safely when it is forward biased. Curves are based upon maximum peak junction temperature and a case temperature ( $T_C$ ) of 25°C. Peak repetitive pulsed power limits are determined by using the thermal response data in conjunction with the procedures discussed in AN569, “Transient Thermal Resistance—General Data and Its Use.”

Switching between the off-state and the on-state may traverse any load line provided neither rated peak current ( $I_{DM}$ ) nor rated voltage ( $V_{DSS}$ ) is exceeded and the transition time ( $t_r, t_f$ ) do not exceed 10  $\mu s$ . In addition the total power averaged over a complete switching cycle must not exceed  $(T_{J(MAX)} - T_C)/(R_{\theta JC})$ .

A Power MOSFET designated E-FET can be safely used in switching circuits with unclamped inductive loads. For

reliable operation, the stored energy from circuit inductance dissipated in the transistor while in avalanche must be less than the rated limit and adjusted for operating conditions differing from those specified. Although industry practice is to rate in terms of energy, avalanche energy capability is not a constant. The energy rating decreases non-linearly with an increase of peak current in avalanche and peak junction temperature

Although many E-FETs can withstand the stress of drain-to-source avalanche at currents up to rated pulsed current ( $I_{DM}$ ), the energy rating is specified at rated continuous current ( $I_D$ ), in accordance with industry custom. The energy rating must be derated for temperature as shown in the accompanying graph (Figure 12). Maximum energy at currents below rated continuous  $I_D$  can safely be assumed to equal the values indicated.

# MTW8N60E

## SAFE OPERATING AREA

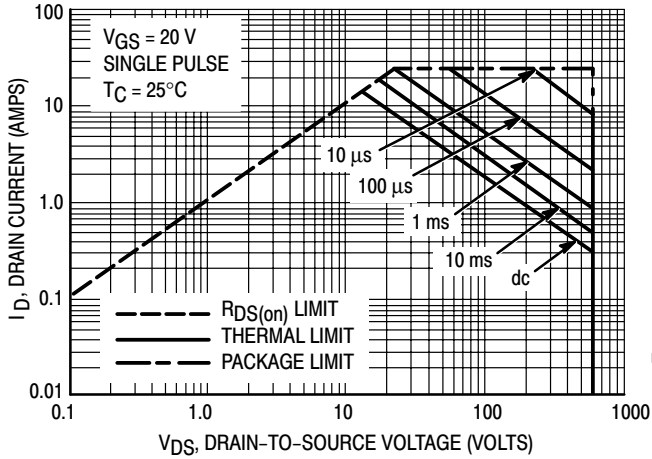

**Figure 11. Maximum Rated Forward Biased Safe Operating Area**

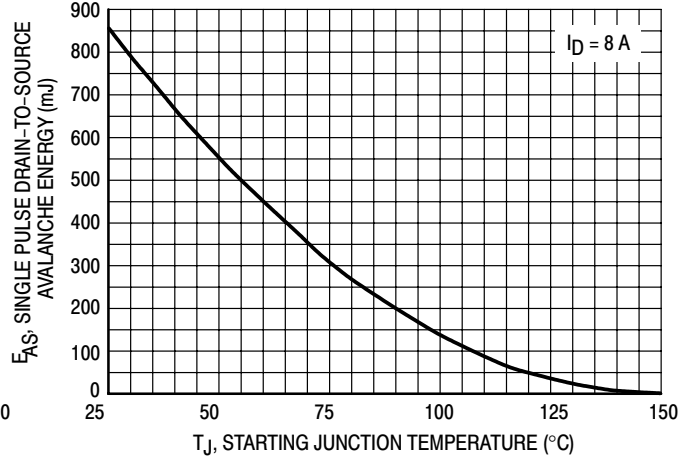

**Figure 12. Maximum Avalanche Energy versus Starting Junction Temperature**

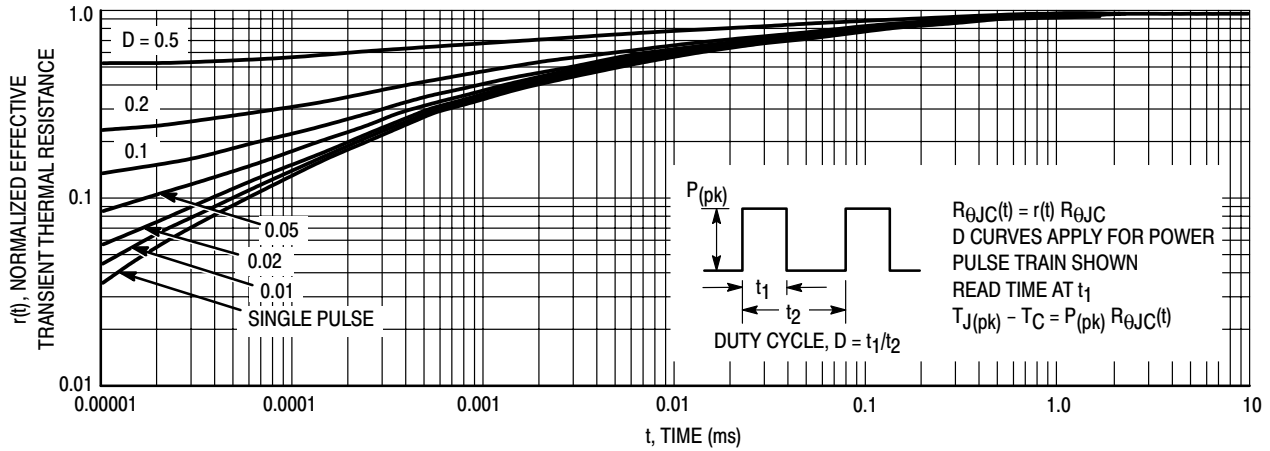

**Figure 13. Thermal Response**

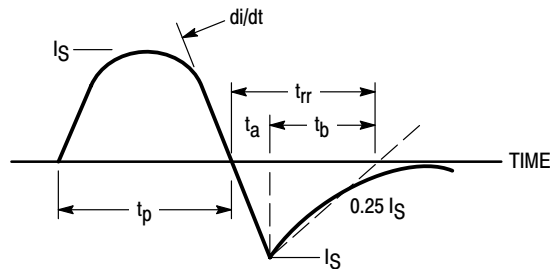
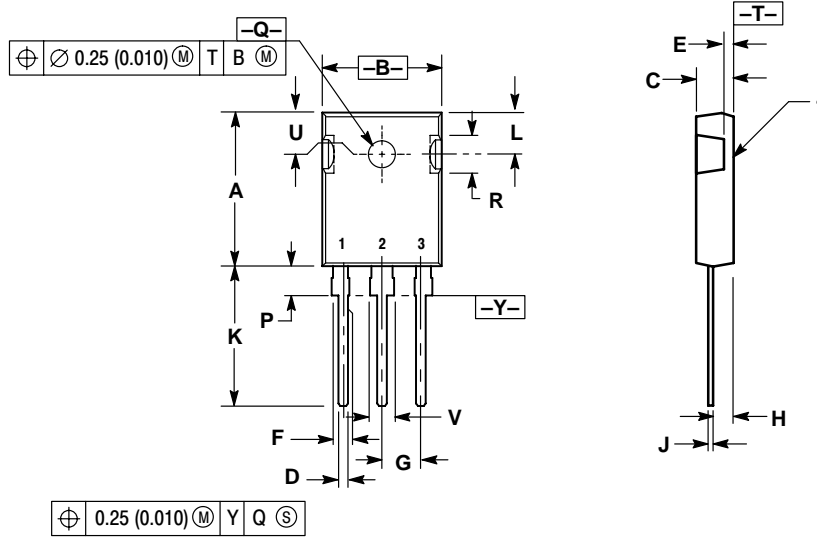

**Figure 14. Diode Reverse Recovery Waveform**

# MTW8N60E

## PACKAGE DIMENSIONS

TO-247  
CASE 340K-01  
ISSUE C



NOTES:  
1. DIMENSIONING AND TOLERANCING PER ANSI Y14.5M, 1982.  
2. CONTROLLING DIMENSION: MILLIMETER.

DIM	MILLIMETERS		INCHES	
	MIN	MAX	MIN	MAX
A	19.7	20.3	0.776	0.799
B	15.3	15.9	0.602	0.626
C	4.7	5.3	0.185	0.209
D	1.0	1.4	0.039	0.055
E	1.27 REF		0.050 REF	
F	2.0	2.4	0.079	0.094
G	5.5 BSC		0.216 BSC	
H	2.2	2.6	0.087	0.102
J	0.4	0.8	0.016	0.031
K	14.2	14.8	0.559	0.583
L	5.5 NOM		0.217 NOM	
P	3.7	4.3	0.146	0.169
Q	3.55	3.65	0.140	0.144
R	5.0 NOM		0.197 NOM	
U	5.5 BSC		0.217 BSC	
V	3.0	3.4	0.118	0.134

STYLE 1:  
PIN 1. GATE  
2. DRAIN  
3. SOURCE  
4. DRAIN

**ON Semiconductor** and  are trademarks of Semiconductor Components Industries, LLC (SCILLC). SCILLC reserves the right to make changes without further notice to any products herein. SCILLC makes no warranty, representation or guarantee regarding the suitability of its products for any particular purpose, nor does SCILLC assume any liability arising out of the application or use of any product or circuit, and specifically disclaims any and all liability, including without limitation special, consequential or incidental damages. "Typical" parameters which may be provided in SCILLC data sheets and/or specifications can and do vary in different applications and actual performance may vary over time. All operating parameters, including "Typicals" must be validated for each customer application by customer's technical experts. SCILLC does not convey any license under its patent rights nor the rights of others. SCILLC products are not designed, intended, or authorized for use as components in systems intended for surgical implant into the body, or other applications intended to support or sustain life, or for any other application in which the failure of the SCILLC product could create a situation where personal injury or death may occur. Should Buyer purchase or use SCILLC products for any such unintended or unauthorized application, Buyer shall indemnify and hold SCILLC and its officers, employees, subsidiaries, affiliates, and distributors harmless against all claims, costs, damages, and expenses, and reasonable attorney fees arising out of, directly or indirectly, any claim of personal injury or death associated with such unintended or unauthorized use, even if such claim alleges that SCILLC was negligent regarding the design or manufacture of the part. SCILLC is an Equal Opportunity/Affirmative Action Employer.

## PUBLICATION ORDERING INFORMATION

### **NORTH AMERICA Literature Fulfillment:**

Literature Distribution Center for ON Semiconductor  
P.O. Box 5163, Denver, Colorado 80217 USA  
**Phone:** 303-675-2175 or 800-344-3860 Toll Free USA/Canada  
**Fax:** 303-675-2176 or 800-344-3867 Toll Free USA/Canada  
**Email:** ONlit@hibbertco.com  
Fax Response Line: 303-675-2167 or 800-344-3810 Toll Free USA/Canada

**N. American Technical Support:** 800-282-9855 Toll Free USA/Canada

**EUROPE:** LDC for ON Semiconductor – European Support

**German Phone:** (+1) 303-308-7140 (Mon-Fri 2:30pm to 7:00pm CET)  
**Email:** ONlit-german@hibbertco.com

**French Phone:** (+1) 303-308-7141 (Mon-Fri 2:00pm to 7:00pm CET)  
**Email:** ONlit-french@hibbertco.com

**English Phone:** (+1) 303-308-7142 (Mon-Fri 12:00pm to 5:00pm GMT)  
**Email:** ONlit@hibbertco.com

**EUROPEAN TOLL-FREE ACCESS\*: 00-800-4422-3781**

\*Available from Germany, France, Italy, UK, Ireland

### **CENTRAL/SOUTH AMERICA:**

**Spanish Phone:** 303-308-7143 (Mon-Fri 8:00am to 5:00pm MST)  
**Email:** ONlit-spanish@hibbertco.com

**Toll-Free from Mexico:** Dial 01-800-288-2872 for Access –  
then Dial 866-297-9322

**ASIA/PACIFIC:** LDC for ON Semiconductor – Asia Support

**Phone:** 303-675-2121 (Tue-Fri 9:00am to 1:00pm, Hong Kong Time)  
**Toll Free from Hong Kong & Singapore:**

**001-800-4422-3781**

**Email:** ONlit-asia@hibbertco.com

**JAPAN:** ON Semiconductor, Japan Customer Focus Center

4-32-1 Nishi-Gotanda, Shinagawa-ku, Tokyo, Japan 141-0031  
**Phone:** 81-3-5740-2700

**Email:** r14525@onsemi.com

**ON Semiconductor Website:** <http://onsemi.com>

For additional information, please contact your local Sales Representative.



This datasheet has been download from:

[www.datasheetcatalog.com](http://www.datasheetcatalog.com)

Datasheets for electronics components.