



Convertor Grade Stud-Base Thyristor Type N105P/N105R

110 amperes average: up to 1500 volts V_{RRM}

Ratings (Maximum values at 125°C Tj unless stated otherwise)

RATING	CONDITIONS	SYMBOL	
Average on-state current	Half sine wave. 90°C case temperature	$I_T(AV)$	110A
R.M.S on-state current		$I_T(RMS)$	175A
Continuous on-state current		I_T	175A
Peak one-cycle surge (non-repetitive) on-state current	10ms duration, 60% V_{RRM} re-applied	$I_{TSM}(1)$	2450A
	10ms duration, $V_R \leq 10$ volts	$I_{TSM}(2)$	2695A
Maximum permissible surge energy	10ms duration, $V_R \leq 10$ volts	$I^2t(2)$	$36300A^2s$
	3ms duration, $V_R \leq 10$ volts	I^2t	$27000A^2s$
Peak forward gate current	Anode positive with respect to cathode	I_{FGM}	19A
Peak forward gate voltage	Anode positive with respect to cathode	V_{FGM}	18V
Peak reverse gate voltage		V_{RGM}	5V
Average gate power		P_G	2W
Peak gate power	100µs pulse width	P_{GM}	100W
Rate of rise of off-state voltage	To 80% V_{DRM} , gate open-circuit	dv/dt	*200V/µs
Rate of rise of on-state current (repetitive)	} Gate drive 20 volts, 20 ohms with $t_r \leq 1\mu s$. } Anode voltage $\leq 80\% V_{DRM}$	$di/dt(1)$	500A/µs
Rate of rise on on-state current (non-repetitive)		$di/dt(2)$	1000A/µs
Operating temperature range		T case	-40 + 125°C
Storage temperature range		T_{stg}	-40 + 150°C

Characteristics (Maximum values at 125°C Tj unless stated otherwise)

CHARACTERISTIC	CONDITIONS	SYMBOL	
Peak on-state voltage	At 377 A, I_{TM}	V_{TM}	1.57V
Forward conduction threshold voltage		V_O	0.9V
Forward conduction slope resistance		r	1.79mΩ
Repetitive peak off-state current	At V_{DRM}	I_{DRM}	20mA
Repetitive peak reverse current	At V_{RRM}	I_{RRM}	20mA
Maximum gate current required to fire all devices	} $V_A = 6V, I_A = 2A$ at 25°C Tj } }	I_{GT}	150mA
Maximum gate voltage required to fire all devices		V_{GT}	3V
Maximum holding current		I_H	600mA
Maximum gate voltage which will not trigger any device		V_{GD}	0.25V
Thermal resistance, junction to case for a device with a maximum forward volt drop characteristic	DC and 180° sine wave	$R_{th(j-c)}$	0.23°C/W
	120° rectangular wave		0.28°C/W
Thermal resistance case to heatsink		$R_{th(c-hs)}$	0.08°C/W

VOLTAGE CODE		H02	H04	H06	H08	H10	H12	H14	H15
Repetitive peak voltages	V_{RRM} V_{DRM} V_{DMS}	200	400	600	800	1000	1200	1400	1500
Non-repetitive peak off-state voltage									
Non-repetitive peak reverse blocking voltage	V_{RSM}	300	500	700	900	1100	1300	1500	1600

Ordering Information (Please quote device code as explained below – 8 digits)

N 1 0 5 P	● ● ●	Typical code: N105PH12 = 1200 V_{RRM} 1200 V_{DRM} , 200 V/µs. dv/dt to 80% V_{DRM}
	Voltage code (see ratings)	

* Other values of dv/dt may be available.

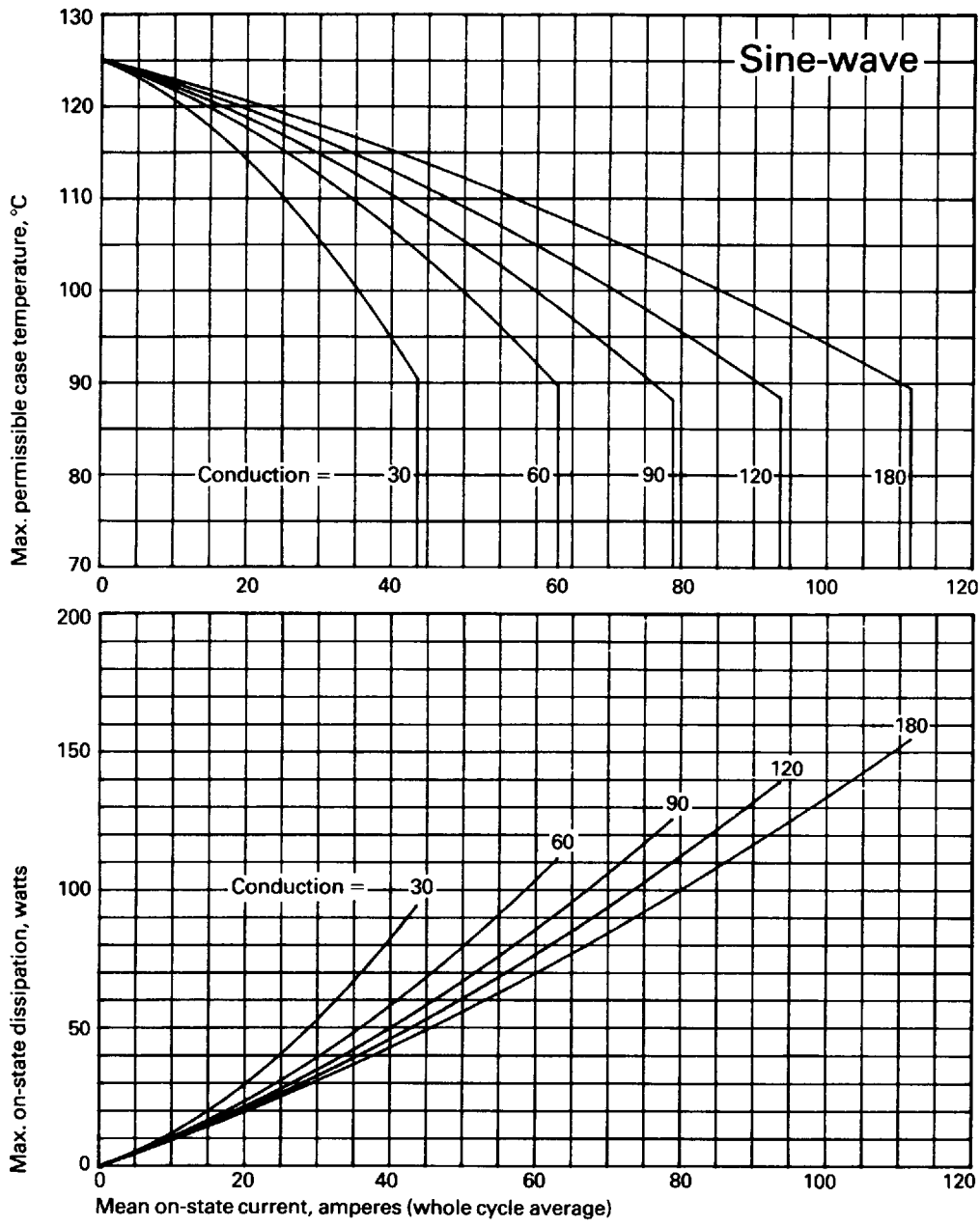

Figure 1 Dissipation and case temperature v. current

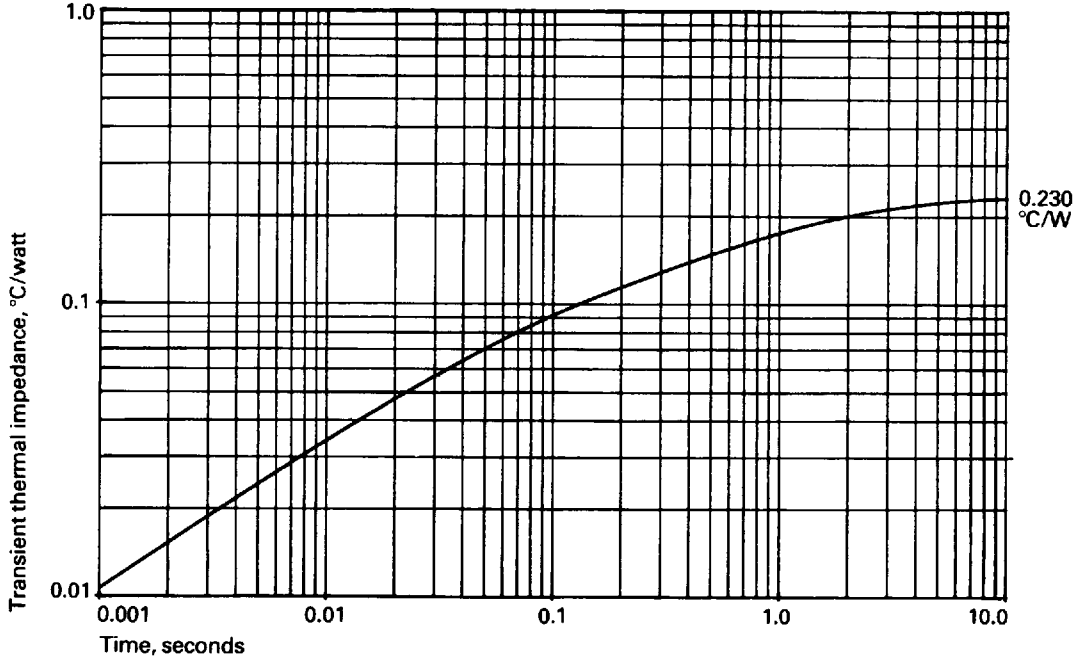

Figure 2 Junction to case thermal impedance

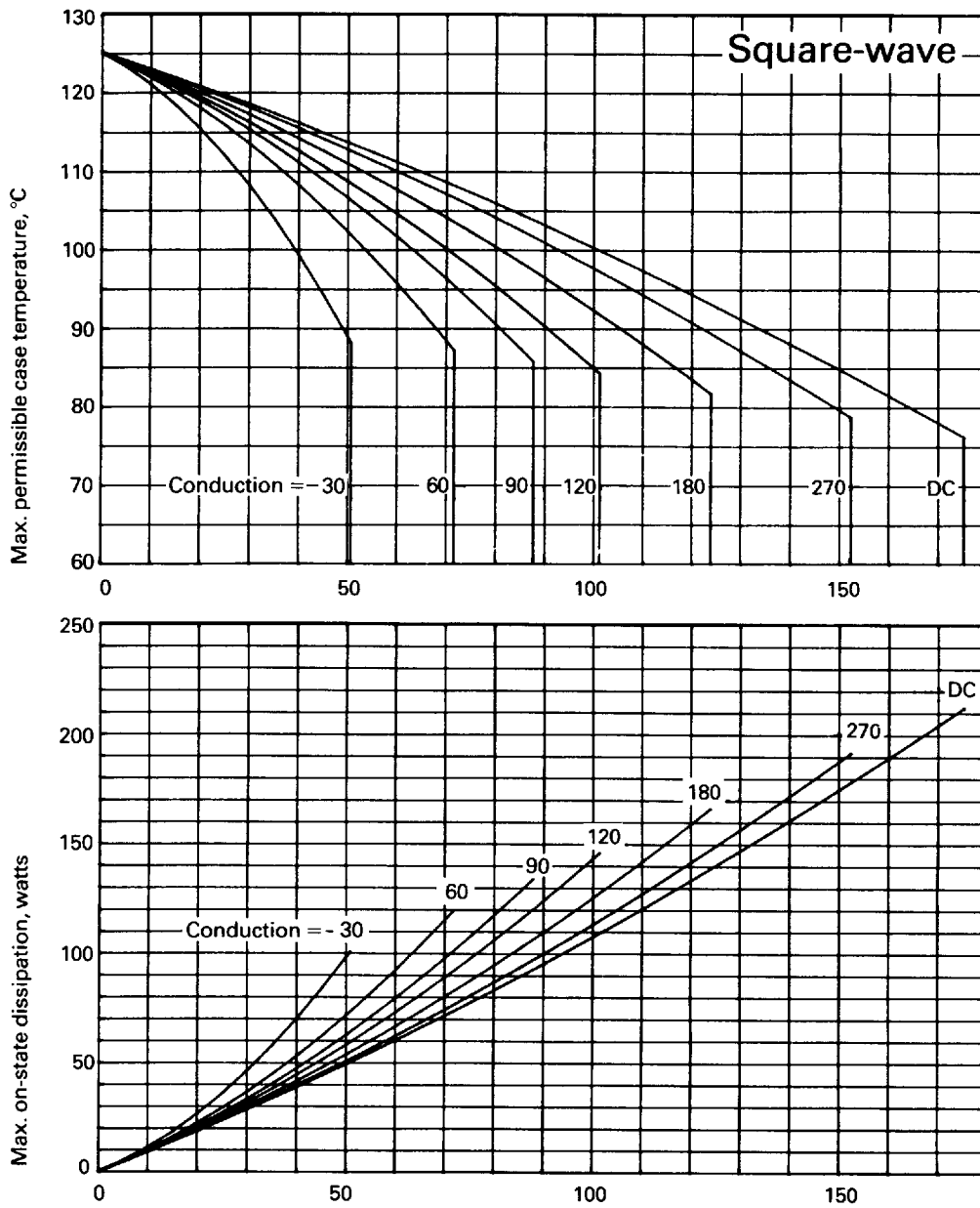

Figure 3 Dissipation and case temperature v. current

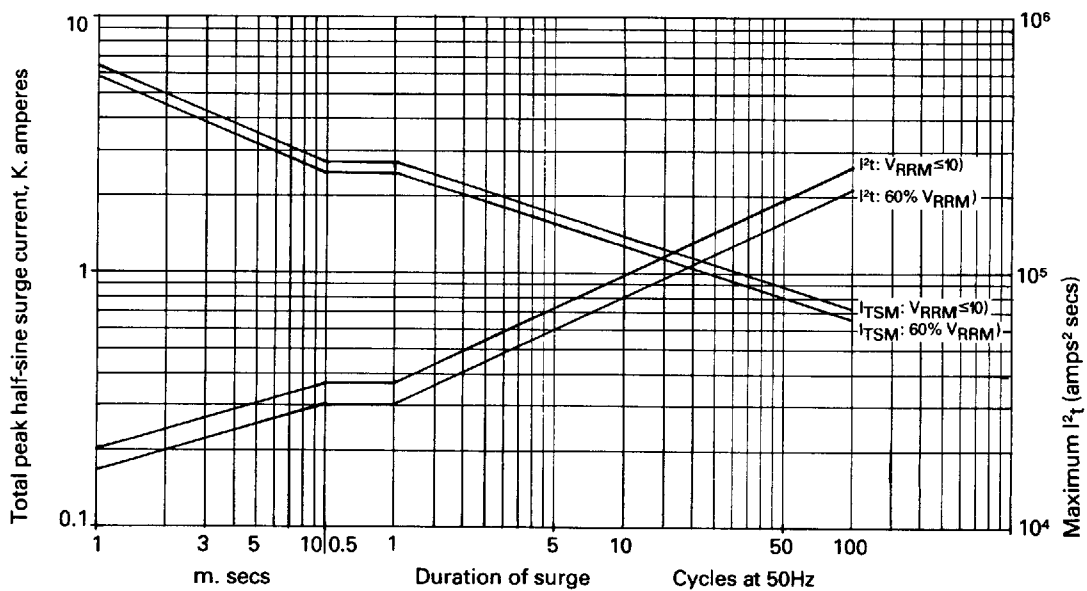

Figure 4 Max. non-repetitive surge current at initial junction temperature 125°C.

(gate may temporarily lose control of firing angle)

Note: This rating must not be interpreted as an intermittent rating

TN105P

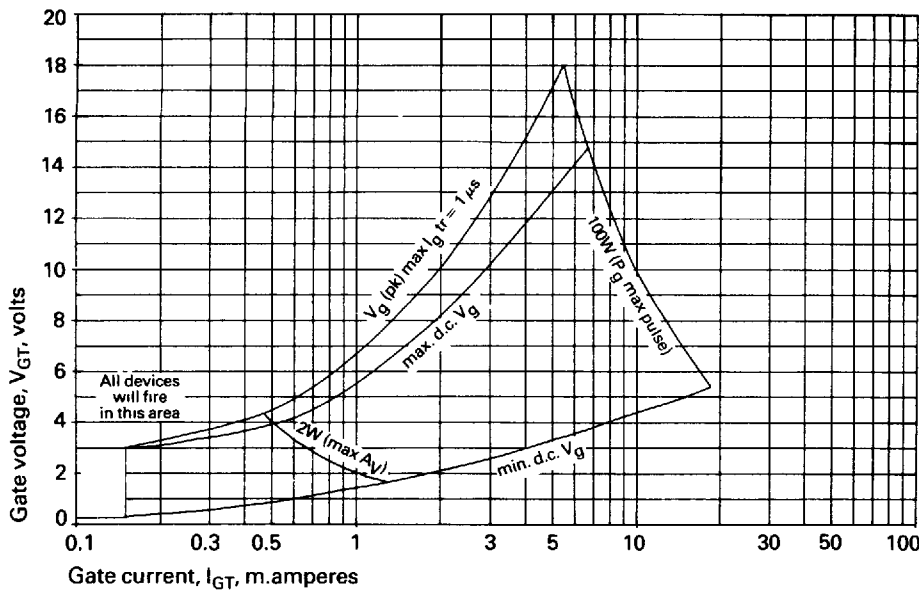

Figure 5 Gate characteristic at 25°C junction temperature

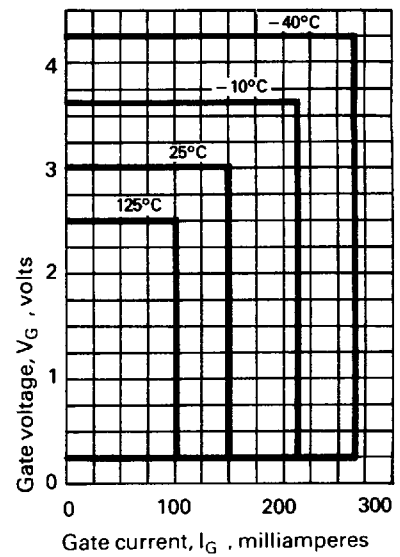

Figure 6 Gate triggering characteristics

Trigger points of all thyristors lie within the areas shown

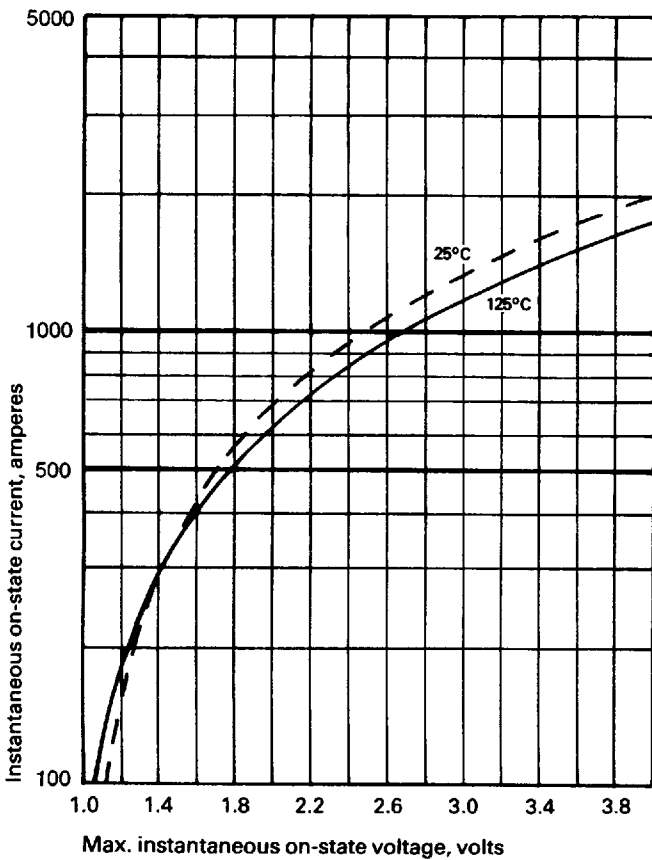
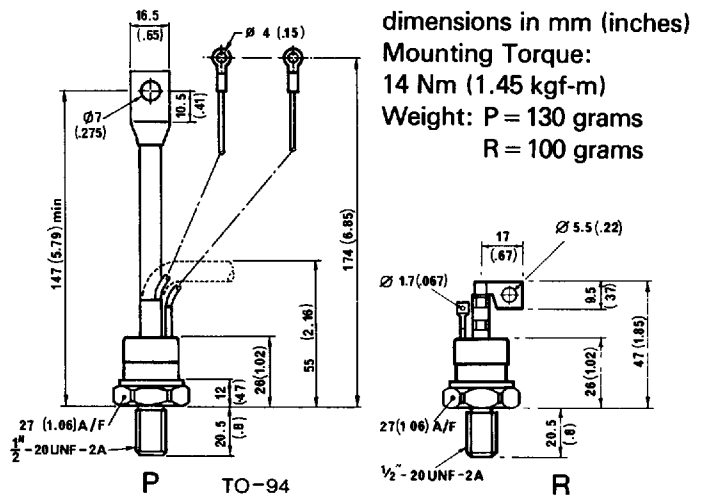

Figure 7 Limit on-state characteristic



In the interest of product improvement, Westcode reserves the right to change specifications at any time without notice.

WESTCODE SEMICONDUCTORS LTD

P.O. Box 57 Chippenham Wiltshire SN15 1JL England
 Telephone Chippenham (0249) 654141 Telex 44751

HAWKER SIDDELEY

Westinghouse Brake and Signal Co. Ltd.

