

PC852 Series PC853/PC853H

* Lead forming type (I type) and taping reel type (P type) are also available. (PC852I/PC852P/PC853I/PC853P)

■ Features

- High collector-emitter voltage
PC852 Series, PC853 ($V_{CEO} : 300V$)
PC853H ($V_{CEO} : 350V$)
- High current transfer ratio
(CTR: MIN. 1 000% at $I_F = 1mA, V_{CE} = 2V$)
- High isolation voltage between input and output ($V_{iso} : 5\ 000V_{rms}$)
- Compact dual-in-line package
PC852, PC853, PC853H (1-channel type)

High Collector-emitter Voltage Type Photocouplers

- PC852I/PC852P/PC853I/PC853P**
PC8D52 (2-channel type)
PC8Q52 (4-channel type)
- Large collector power dissipation.
PC853, PC853H ($P_c : 300mW$)
- Recognized by UL (NO. E64380)

■ Applications

- Telephone sets
- Copiers, facsimiles
- Interface with various power supply circuits, power distribution boards
- Numerical control machines

(Unit : mm)

■ Outline Dimensions

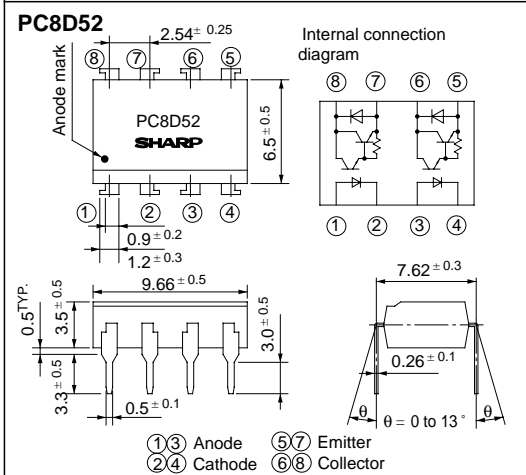
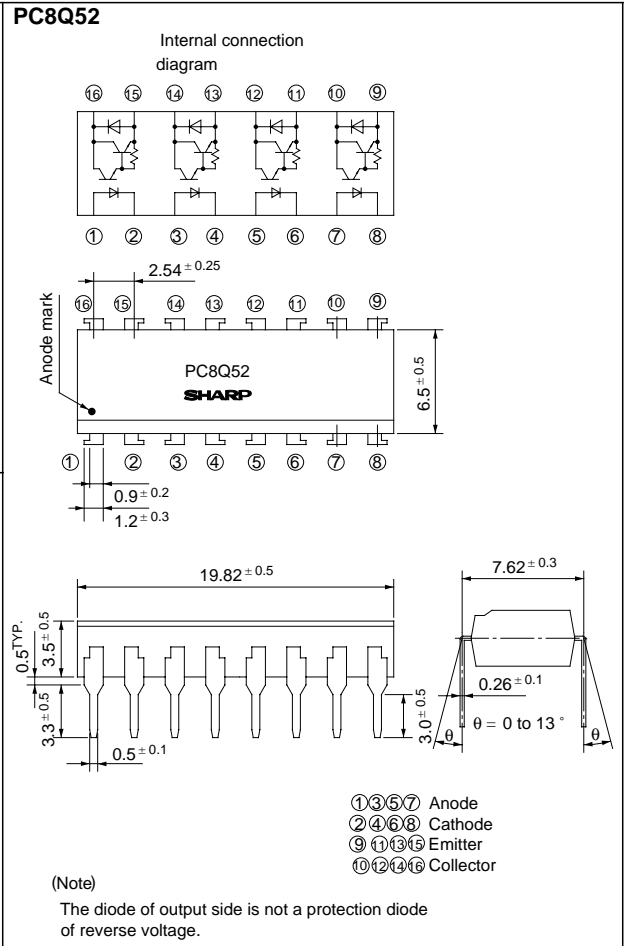
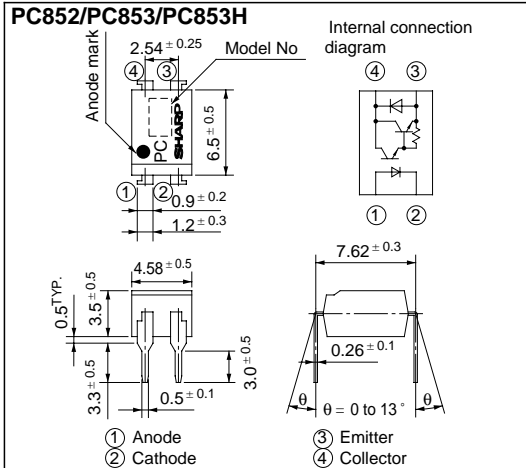

Absolute Maximum Ratings

(Ta = 25°C)

Parameter	Symbol	Rating			Unit
		PC852 Series	PC853	PC853H	
Input	Forward current	I _F	50	50	mA
	*1 Peak forward current	I _{FM}	1	1	A
	Reverse voltage	V _R	6	6	V
	Power dissipation	P	70	70	mW
Output	Collector-emitter voltage	V _{CEO}	300	300 350	V
	Emitter-collector voltage	V _{ECO}	0.1	0.1	V
	Collector current	I _C	150	150	mA
	Collector power dissipation	P _C	150	300	mW
	Total power dissipation	P _{tot}	200	320	mW
*2 Isolation voltage	V _{iso}	5 000	5 000	V _{rms}	
Operating temperature	T _{opr}	- 30 to + 100	- 30 to + 100	°C	
Storage temperature	T _{stg}	- 55 to + 125	- 55 to + 125	°C	
*3 Soldering temperature	T _{sol}	260	260	°C	

*1 Pulse width ≤ 100μs, Duty ratio : 0.001

*2 40 to 60% RH, AC for 1 minute

*3 For 10 seconds

Electro-optical Characteristics

(Ta = 25°C)

Parameter		Symbol	Conditions	MIN.	TYP.	MAX.	Unit
Input	Forward voltage	V _F	I _F = 10mA	-	1.2	1.4	V
	Reverse current	I _R	V _R = 4V	-	-	10	μA
	Terminal capacitance	C _t	V = 0, f = 1kHz	-	30	250	pF
Output	Collector dark current	I _{CEO}	V _{CE} = 200V, I _F = 0	-	-	2 x 10 ⁻⁷	A
Transfer characteristics	Current transfer ratio	CTR	I _F = 1mA, V _{CE} = 2V	1 000	4 000	15 000	%
	Collector-emitter saturation voltage	V _{CE(sat)}	I _F = 20mA, I _C = 100mA	-	-	1.2	V
	Isolation resistance	R _{ISO}	DC500V, 40 to 60% RH	5 x 10 ¹⁰	10 ¹¹	-	Ω
	Floating capacitance	C _f	V = 0, f = 1MHz	-	0.6	1.0	pF
	Cut-off frequency	f _c	V _{CE} = 2V, I _C = 20mA, R _L = 100Ω, - 3dB	1	7	-	kHz
	Response time	Rise time	t _r	V _{CE} = 2V, I _C = 20mA	-	100	300
Fall time		t _f	R _L = 100Ω	-	20	100	μs

Fig. 1 Forward Current vs. Ambient Temperature

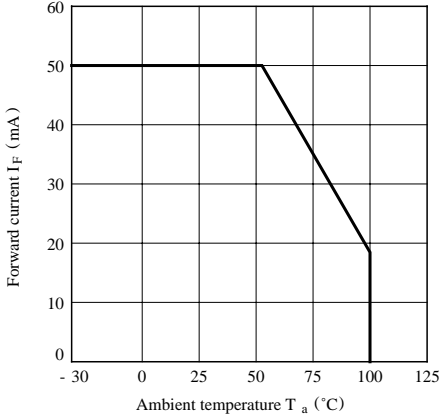

Fig. 2-a Collector Power Dissipation vs. Ambient Temperature (PC852 Series)

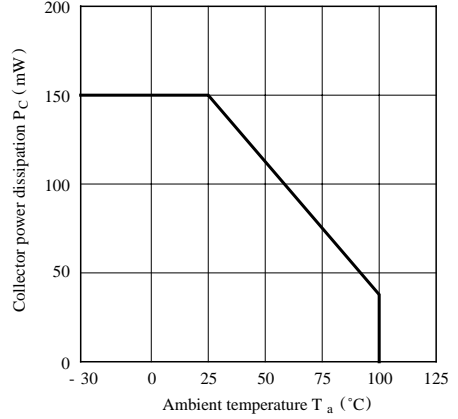

Fig. 2-b Collector Power Dissipation vs. Ambient Temperature (PC853/PC853H)

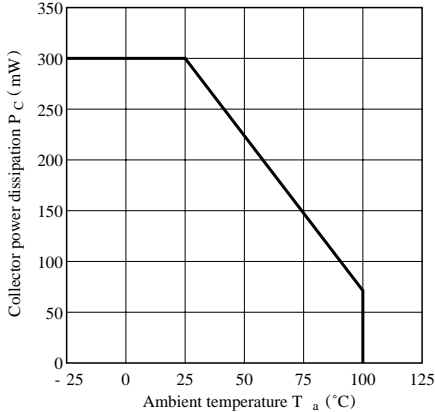

Fig. 3 Peak Forward Current vs. Duty Ratio

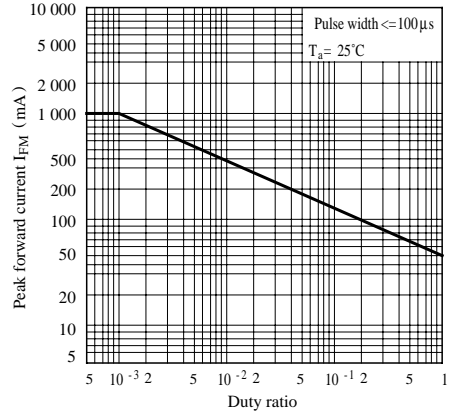

Fig. 4 Forward Current vs. Forward Voltage

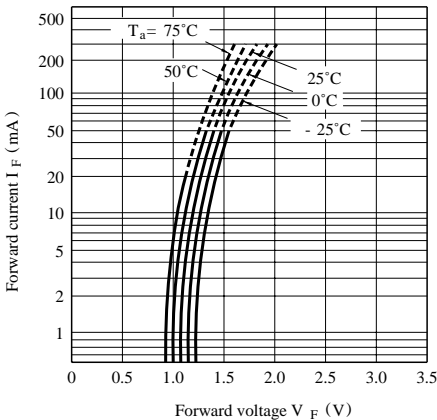

Fig. 5-a Current Transfer Ratio vs. Forward Current (PC852 Series)

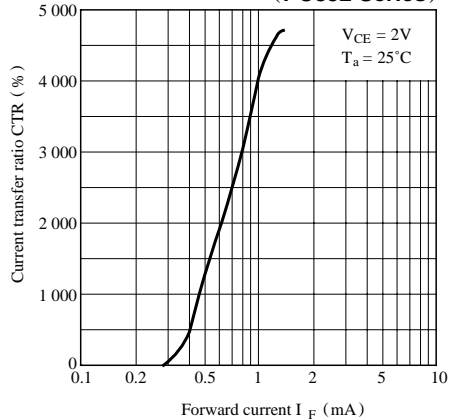

Fig. 5-b Current Transfer Ratio vs. Forward Current

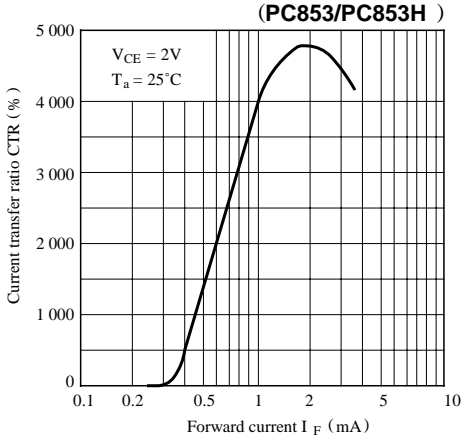

Fig. 6-a Collector Current vs. Collector-emitter Voltage
(PC852 Series)

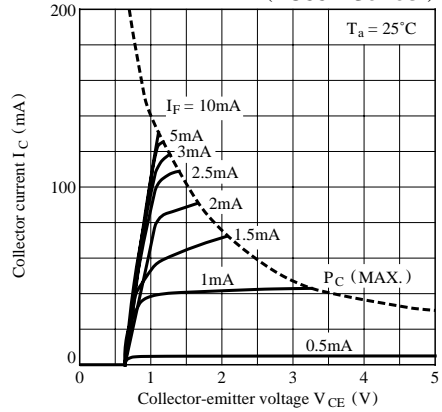

Fig. 6-b Collector Current vs. Collector-emitter Voltage
(PC853 / PC853H)

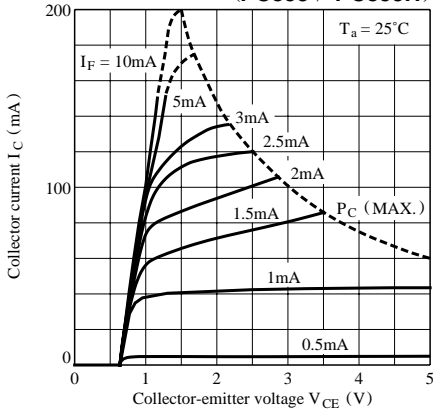

Fig. 7 Relative Current Transfer Ratio vs. Ambient Temperature

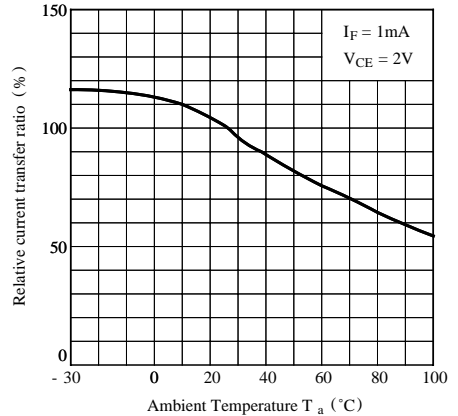

Fig. 8 Collector-emitter Saturation Voltage vs. Ambient Temperature

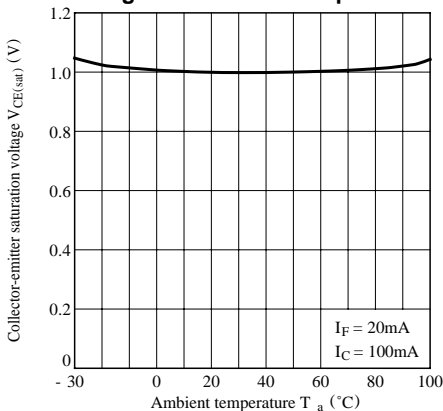

Fig. 9 Collector Dark Current vs. Ambient Temperature

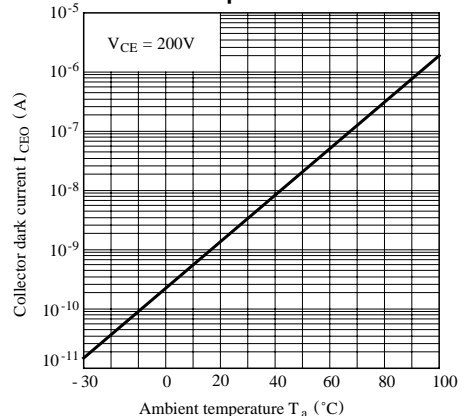

Fig.10 Response Time vs. Load Resistance

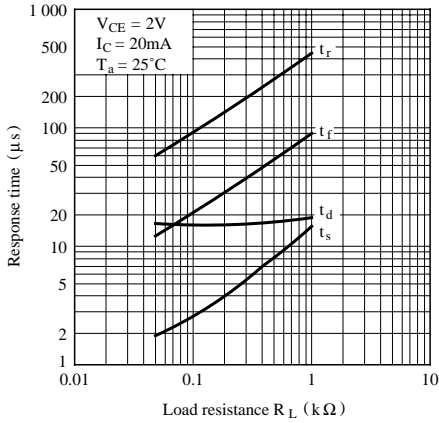

Fig.11 Frequency Response

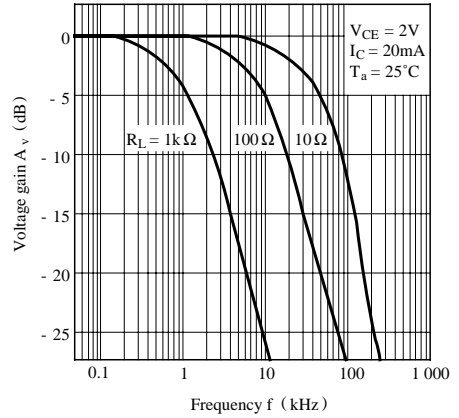
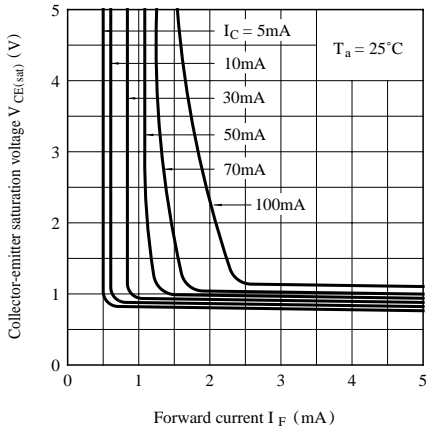

Fig.12 Collector-emitter Saturation Voltage vs. Forward Current



● Please refer to the chapter “Precautions for Use”

This datasheet has been download from:

www.datasheetcatalog.com

Datasheets for electronics components.