

1 Mbps, OPEN-COLLECTOR OUTPUT FOR GATE DRIVE INTERFACE INTELLIGENT POWER MODULE 5-PIN SOP PHOTOCOUPLER

PS9713

FEATURES

- **HIGH INSTANTANEOUS COMMON MODE REJECTION VOLTAGE**
CMH, CML = ± 15 kV/ μ s MIN
- **HIGH SPEED RESPONSE**
tPHL= 500 ns MAX, tPLH = 750 ns MAX
- **MAXIMUM PROPAGATION DELAYS**
tPLH- tPHL = 270 ns TYP
- **PULSE WIDTH DISTORTION**
| tPHL- tPLH | = 270 ns TYP
- **SMALL THIN PACKAGE**
5-pin SOP
- **TAPING PRODUCT NUMBER**
PS9713-F3, F4: 3,500 pcs/reel

DESCRIPTION

PS9713 is an optically coupled isolator containing a GaAlAs LED on the input side and a photo diode and a signal processing circuit on the output side on one chip.

APPLICATIONS

- **IPM DRIVER**
- **GENERAL PURPOSE INVERTER**

ELECTRICAL CHARACTERISTICS¹ (TA = -40 to +100°C, VCC = 15 V unless otherwise specified)

		PART NUMBER	PS9713			
	SYMBOL	PARAMETERS	UNITS	MIN	TYP	MAX
Diode	V _F	Forward Voltage, I _F = 10 mA	V	1.3	1.65	2.1
	I _R	Reverse Current, V _R = 3 V	μ A			200
	C _t	Terminal Capacitance, V = 0 V, f = 1 MHz, T _A = 25°C	pF		30	
Detector	V _{OL}	Low Level Output Voltage I _F = 10 mA, V _{CC} = 5 V, I _O = 2.4 mA	V		0.13	0.6
	I _{OH}	High Level Output Current V _{CC} = 30 V, V _F = 0.8 V	μ A		1.0	50
	I _{CCH}	High Level Supply Current, V _{CC} = 30 V, V _F = 0.8 V, V _O = open	mA		0.6	1.3
	I _{CCL}	Low Level Supply Current, V _{CC} = 30 V, I _F = 10 mA, V _O = open	mA		0.6	1.3
Coupled	I _{FHL}	Threshold Input Current (High \rightarrow Low), V _O = 0.8 V, I _O = 0.75 mA	mA		1.5	5.0
	CTR	Current Transfer Ratio, I _F = 10 mA, V _O = 0.6 V	%	44	110	
	R _{I-O}	Isolation Resistance, V _{I-O} = 1 k V _{DC} , R _H = 40 to 60%, T _A = 25°C	Ω	10 ¹¹		
	C _{I-O}	Isolation Capacitance, V = 0, f = 1 MHz, T _A = 25°C	pF		0.6	
	t _{PHL}	Propagation Delay Time ² , High \rightarrow Low I _F = 10 mA, R _L = 20 k Ω , C _L = 100 pF, V _{THHL} = 1.5 V, V _{THLH} = 2.0 V	ns		250	500
	t _{PLH}	Propagation Delay Time ² , High \rightarrow Low I _F = 10 mA, R _L = 20 k Ω , C _L = 100 pF, V _{THHL} = 1.5 V, V _{THLH} = 2.0 V	ns		520	750
	t _{PLH-t_{PHL}}	Maximum Propagation Delays I _F = 10 mA, R _L = 20 k Ω , C _L = 100 pF, V _{THHL} = 1.5 V, V _{THLH} = 2.0 V	ns	-200	270	650
	t _{PLH-t_{PHL}}	Pulse Width Distortion (PWD) ² I _F = 10 mA, R _L = 20 k Ω , C _L = 100 pF, V _{THHL} = 1.5 V, V _{THLH} = 2.0 V	ns		270	650
	CMH	Instantaneous Common Mode Rejection Voltage (Output:High) ³ T _A = 25°C, I _F = 0 mA, V _O > = 3.0 V, V _{CM} = 1.5 kV, R _L = 20 k Ω , C _L = 100 pF	kV/ μ s	15		
CML	Instantaneous Common Mode Rejection Voltage (Output:High) ³ T _A = 25°C, I _F = 10 mA, V _O < = 1.0 V, V _{CM} = 1.5 kV, R _L = 20 k Ω , C _L = 100 pF	kV/ μ s	15			

Notes: See Next Page

Notes:

1. Typical values at $T_A = 25\text{ }^\circ\text{C}$.
2. Test Circuit for Propagation delay time

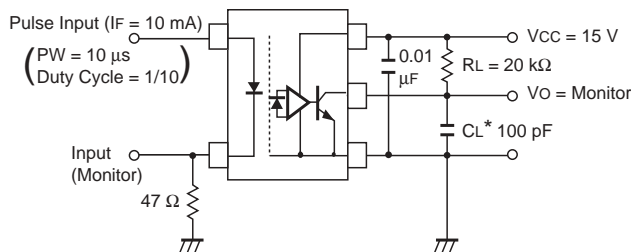

*CL includes probe and stray wiring capacitance.

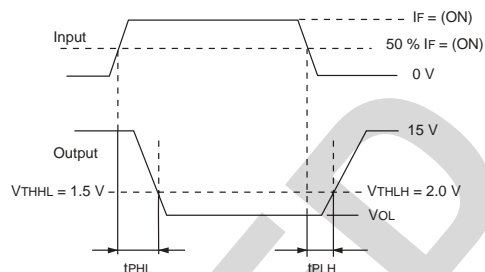

3. Test circuit for common mode transient immunity

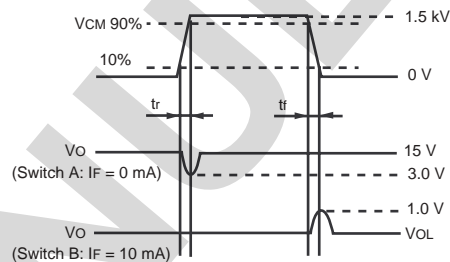
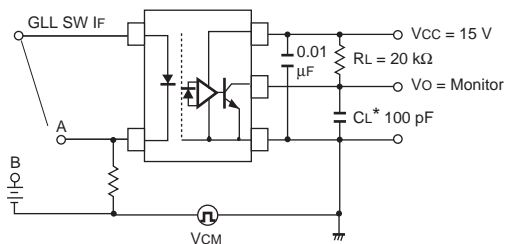

USAGE CAUTION

Bypass capacitor of more than 0.1 μF is used between Vcc and GND near device. Also, ensure that the distance between the leads of the photocoupler and capacitor is no more than 10 mm.

ABSOLUTE MAXIMUM RATINGS¹ ($T_A = 25\text{ }^\circ\text{C}$)

SYMBOLS	PARAMETERS	UNITS	RATINGS
Diode			
IF	Forward Current	mA	25
VR	Reverse Voltage	V	3.0
Detector			
Vcc	Supply Voltage	V	-0.5 to +35
Vo	Output Voltage	V	-0.5 to +35
Io	Output Current	mA	15
Pc	Power Dissipation	mW	100
Coupler			
BV	Isolation Voltage ²	V _{r.m.s.}	2500
TA	Operating Ambient Temp.	$^\circ\text{C}$	-40 to +100
TSTG	Storage Temperature	$^\circ\text{C}$	-55 to +125

Notes:

1. Operation in excess of any one of these parameters may result in permanent damage.
2. AC voltage for 1 minute at $T_A = 25\text{ }^\circ\text{C}$, RH = 60% between input and output.

RECOMMENDED OPERATING CONDITIONS

PART NUMBER			PS9713		
SYMBOLS	PARAMETERS	UNITS	MIN	TYP	MAX
IFH	High Level Input Current	mA	10		20
Vo	Output Voltage	V	0		30
Vcc	Supply Voltage	V	4.5		30
VF	LED off Voltage	V	0		0.8

ORDERING INFORMATION

PART NUMBER	PACKAGE	PACKING STYLE
PS9713	5-pin SOP	Magazine case 100 pcs
PS9713-F3		Embossed Tape 3500 pcs/reel
PS9713-F4	5-pin SOP	Magazine case 100 pcs
PS9713-V		
PS9713-V-F3		

OUTLINE DIMENSIONS (Units in mm)

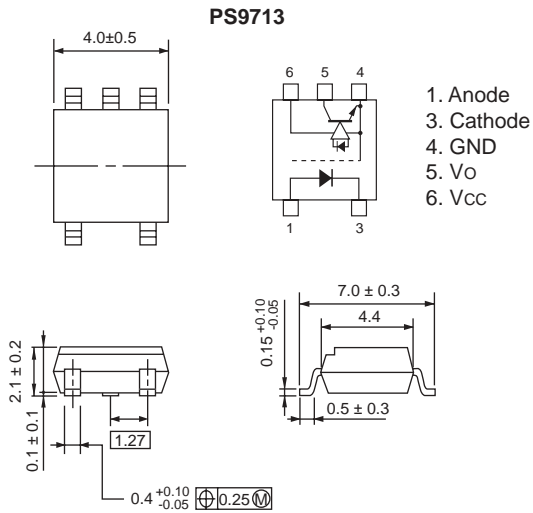

FUNCTIONAL DIAGRAM

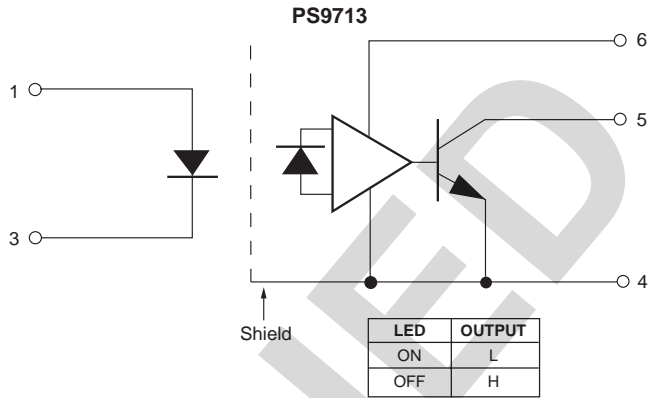

TYPICAL PERFORMANCE CURVES (TA = 25°C, unless otherwise specified)

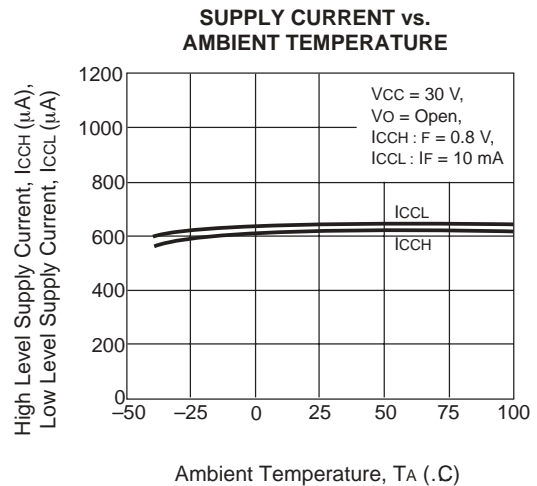
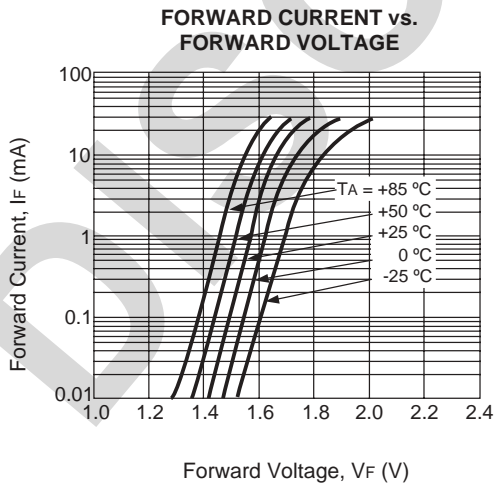
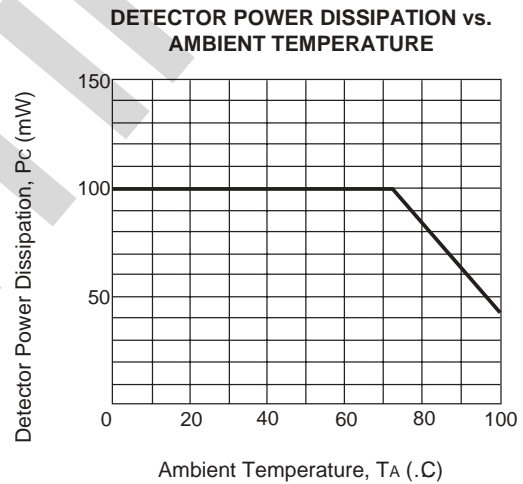
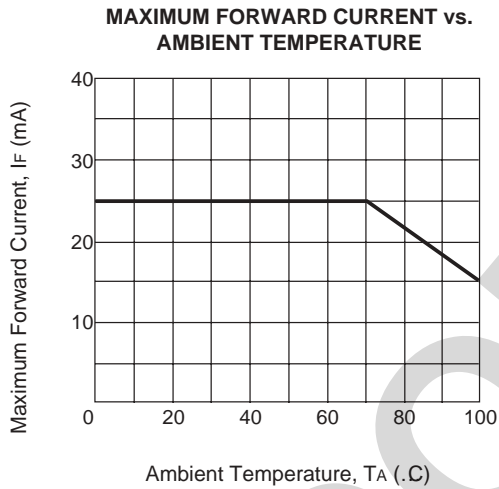

TYPICAL PERFORMANCE CURVES ($T_A = 25^\circ\text{C}$, unless otherwise specified)

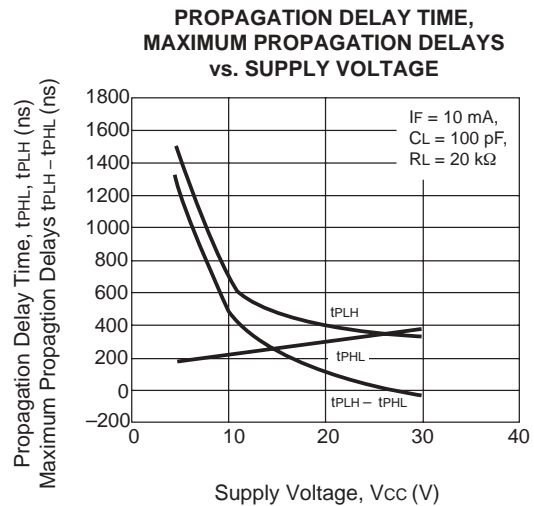
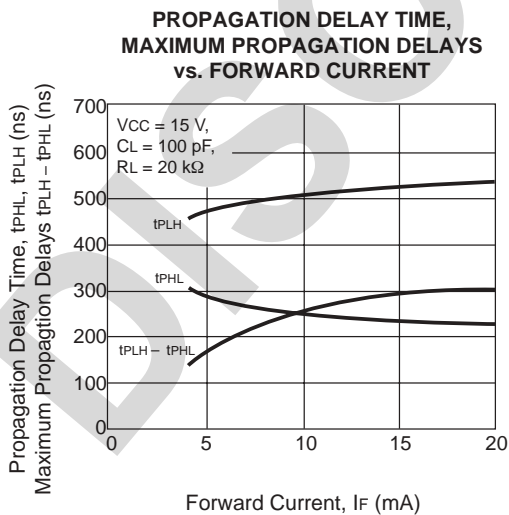
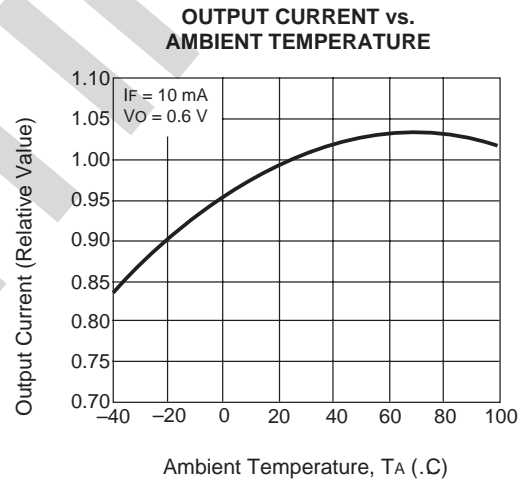
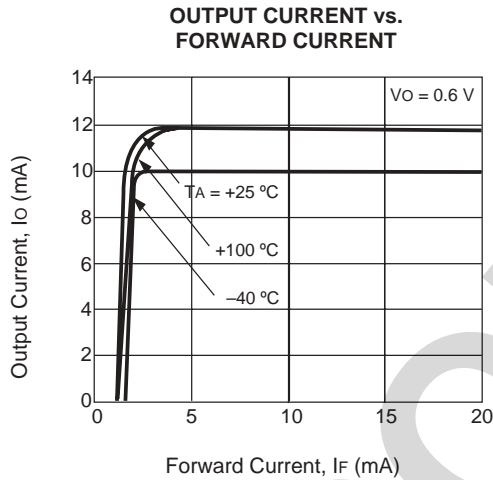
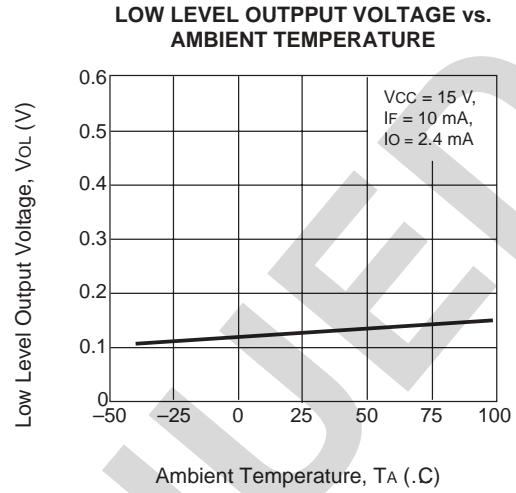
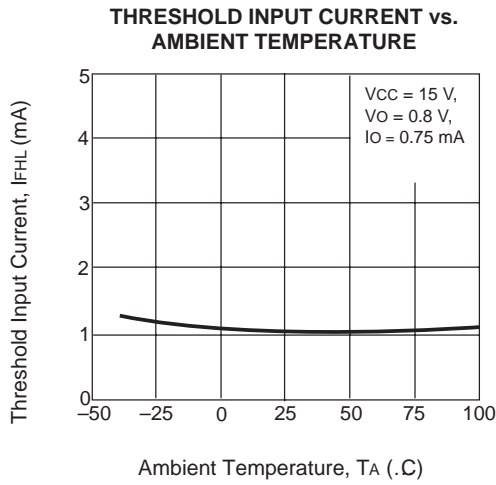

TYPICAL PERFORMANCE CURVES (TA = 25°C)

PROPAGATION DELAY TIME,
PULSE WIDTH DISTORTION
vs. AMBIENT TEMPERATURE

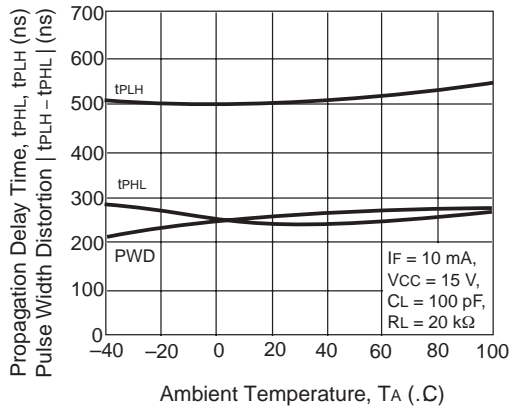

PROPAGATION DELAY TIME vs.
LOAD CAPACITANCE

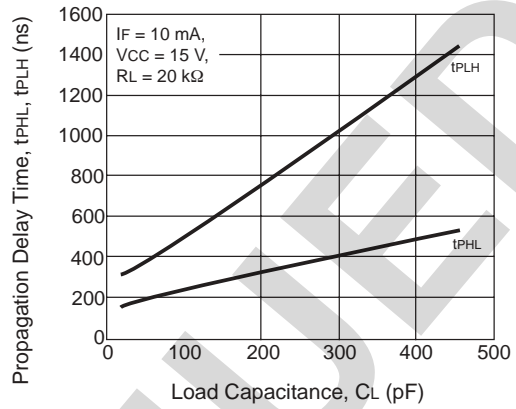

PROPAGATION DELAY TIME,
MAXIMUM PROPAGATION DELAYS
vs. LOAD RESISTANCE

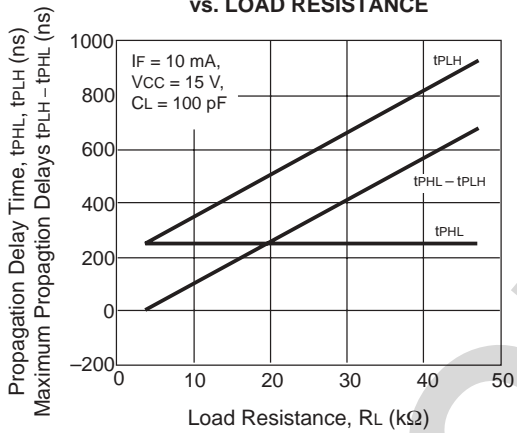

PROPAGATION DELAY TIME,
MAXIMUM PROPAGATION DELAYS
vs. LOAD RESISTANCE

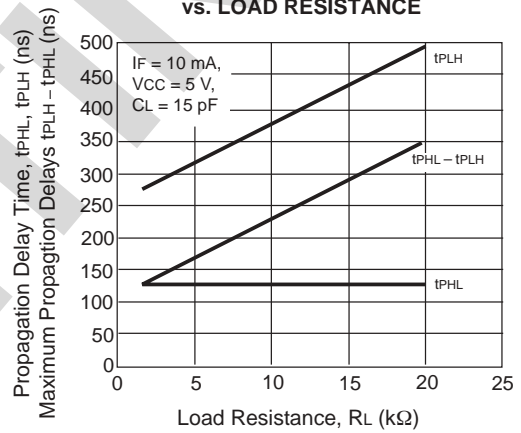

TAPING SPECIFICATIONS (Units in mm)

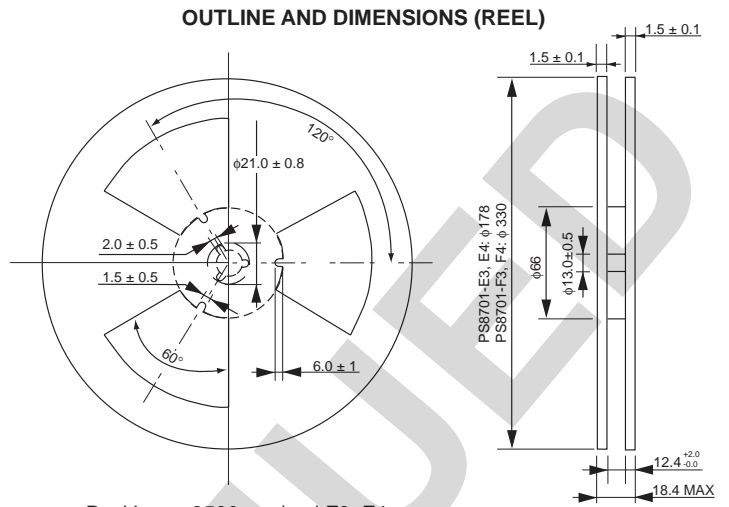
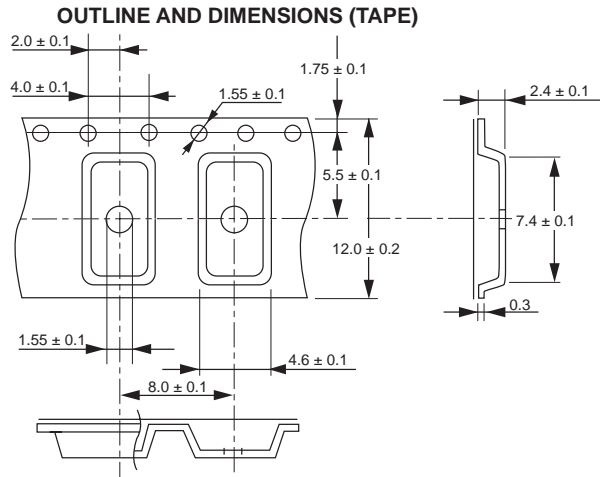

TAPE DIRECTION

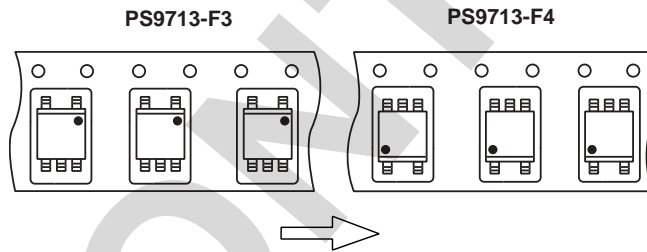

DISCO

RECOMMENDED SOLDERING CONDITIONS

(1) Infrared reflow soldering

- **Peak reflow temperature** 235 °C (package surface temperature)
- **Time of temperature higher than 210 °C** 30 seconds or less
- **Number of reflows** Three
- **Flux** Rosin flux containing small amount of chlorine (The flux with a max. chlorine content of 0.2 Wt % is recommended)

Recommended Temperature Profile of Infrared Reflow

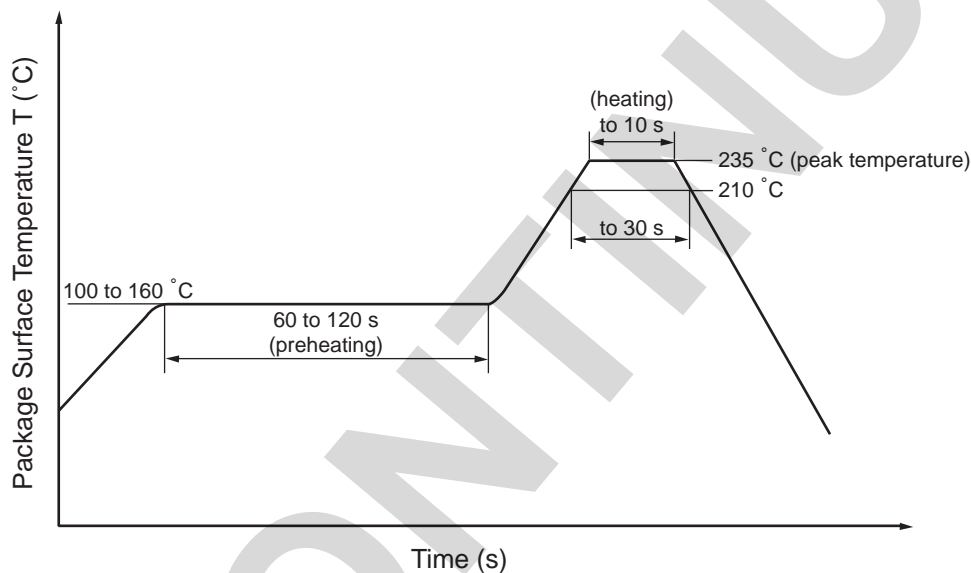

(2) Dip soldering

- **Temperature** 260 °C or below (molten solder temperature)
- **Time** 10 seconds or less
- **Number of times** One (Allowed to be dipped in solder including plastic mold portion.)
- **Flux** Rosin flux containing small amount of chlorine (The flux with a max. chlorine content of 0.2 Wt % is recommended.)

(3) Cautions

- **Fluxes** Avoid removing the residual flux with freon-based and chlorine-based cleaning solvent.

EXCLUSIVE NORTH AMERICAN AGENT FOR **NEC** RF, MICROWAVE & OPTOELECTRONIC SEMICONDUCTORS

CEL CALIFORNIA EASTERN LABORATORIES • Headquarters • 4590 Patrick Henry Drive • Santa Clara, CA 95054-1817 • (408) 988-3500 • Telex 34-6393 • FAX (408) 988-0279
24-Hour Fax-On-Demand: 800-390-3232 (U.S. and Canada only) • Internet: <http://WWW.CEL.COM>

DATA SUBJECT TO CHANGE WITHOUT NOTICE

08/30/2001