

Powerex, Inc., 200 Hillis Street, Youngwood, Pennsylvania 15697-1800 (412) 925-7272  
 Powerex, Europe, S.A. 428 Avenue G. Durand, BP107, 72003 Le Mans, France (43) 41.14.14

**Fast Recovery Rectifier**  
**400 Amperes Average**  
**1600 Volts**

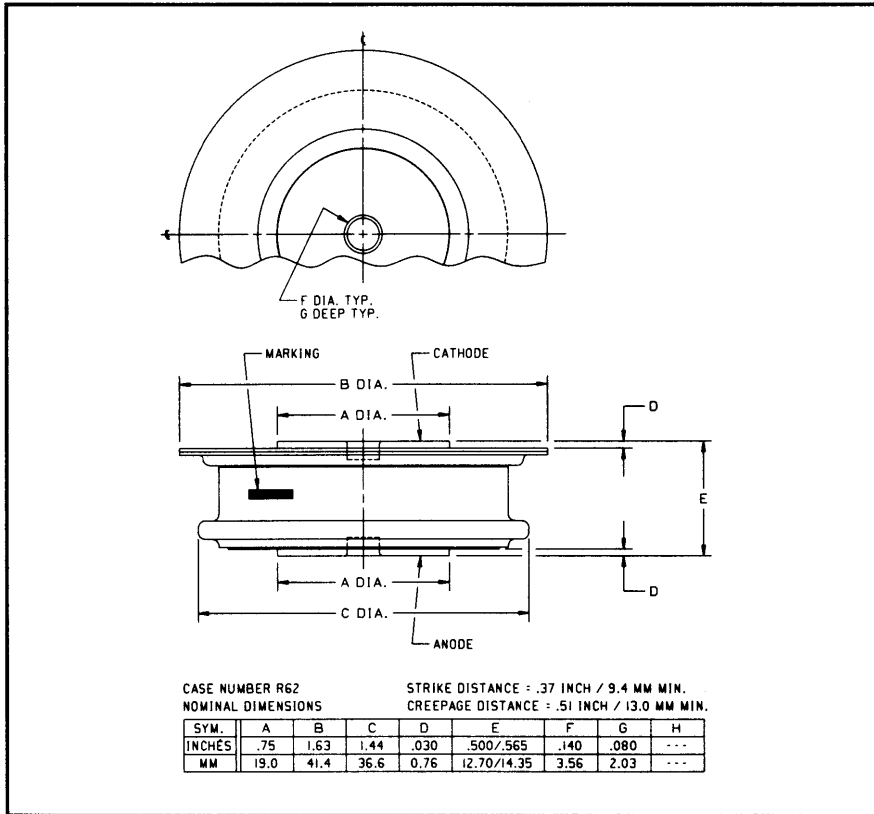

R622\_40 (Outline Drawing)

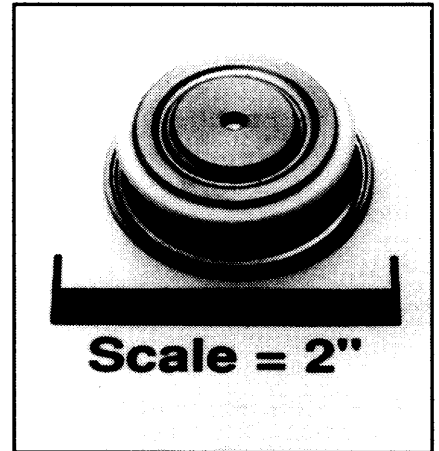

R622\_40  
**Fast Recovery Rectifier**  
 400 Amperes Average, 1600 Volts

**Features:**

- Fast Recovery Times
- Soft Recovery Characteristics
- High Surge Current Ratings
- High Rated Blocking Voltages
- Special Electrical Selection for Parallel and Series Operation
- Single or Double-sided Cooling
- Long Creepage and Strike Paths
- Hermetic Seal
- Special Selection of Recovery Characteristics Available

**Applications:**

- Inverters
- Choppers
- Transmitters
- Free Wheeling Diode

**Ordering Information:**

Select the complete part number you desire from the following table:

Type	Voltage		Current		Recovery Time		Leads	
	V <sub>RRM</sub> (Volts)	Code	I <sub>F(av)</sub> (A)	Code	t <sub>rr</sub> (μsec)	Code	Case	Code
R622	400	04	400	40	1.0	HS	R62	OO
	600	06						
	800	08						
	1000	10						
	1200	12						
	1400	14						
	1600	16						

**Example:** Type R622 rated at 400A average with V<sub>RRM</sub> = 1600V,  
 Recovery Tme = 1.0μsec, order as:

Type	Voltage		Current		Time	Leads				
R	6	2	2	1	6	4	0	HS	O	O
R	6	2	2	1	6	4	0	HS	O	O

**R622\_40**

**Fast Recovery Rectifier**

400 Amperes Average, 1600 Volts

**Absolute Maximum Ratings**

Characteristics	Symbol	R622_40	Units
RMS Forward Current	$I_{F(rms)}$	625	Amperes
Average Forward Current	$I_{F(av)}$	400	Amperes
One-half Cycle Surge Current	$I_{FSM}$	4500	Amperes
$i^2t$ (for Fusing), Times = 8.3 milliseconds	$i^2t$	85000	A <sup>2</sup> sec
Max. $i^2t$ of Package (for Times = 8.3 milliseconds)	$i^2t$	20 x 10 <sup>6</sup>	A <sup>2</sup> sec
Storage Temperature	$T_{stg}$	40 to +190	°C
Operating Temperature	$T_j$	40 to +150	°C
Mounting Force		1000 to 1400	lbs

**Electrical and Thermal Characteristics**

Characteristics	Symbol	Test Conditions	R622_40	Units
<b>Current - Conducting State Maximums</b>				
Forward Voltage Drop	$V_{FM}$	$T_j = 25^\circ\text{C}, I_{FM} = 800\text{A}$	2.0	Volts
<b>Voltage - Blocking State Maximums</b>				
Repetitive Peak Reverse Voltage (Rated Limit)	$V_{RRM}$		1600	Volts
Non-rep. Trans. Peak Rev. Voltage (Rated Limit)	$V_{RSM}$	$t \leq 5.0\text{msec}$	1800	Volts
Reverse Leakage Current, mA peak	$I_{RRM}$	$T_j$ at max., $V_{RRM} = \text{Rated}$	50	mA
<b>Switching</b>				
Maximum Reverse Recovery Time	$t_{rr}$	$I_{FM} = 785\text{A}, t_p = 100\mu\text{sec},$ $di_F/dt = 25\text{A}/\mu\text{sec}, T_C = 25^\circ\text{C}$	1.0	$\mu\text{sec}$
<b>Thermal</b>				
Maximum Resistance, Junction to Case	$R_{\theta(j-c)}$		0.095	°C/Watt
Maximum Resistance, Case to Sink (Lubricated)	$R_{\theta(c-s)}$		0.025	°C/Watt

Powerex, Inc., 200 Hillis Street, Youngwood, Pennsylvania 15697-1800 (412) 925-7272  
 Powerex, Europe, S.A. 428 Avenue G. Durand, BP107, 72003 Le Mans, France (43) 41.14.14

**R622\_40**  
**Fast Recovery Rectifier**  
 400 Amperes Average, 1600 Volts

Reverse Recovery Wave Form

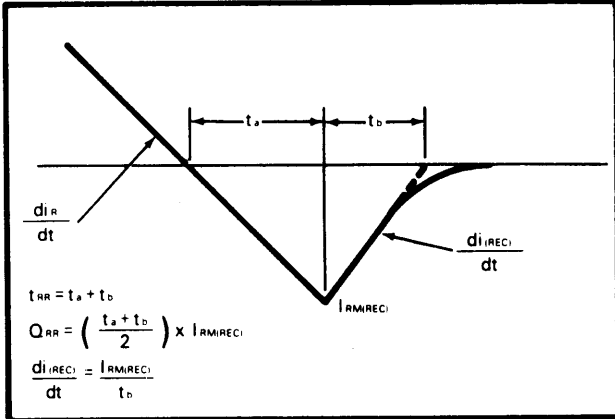

Typical Reverse Recovery Time Vs. Rate of Current Fall

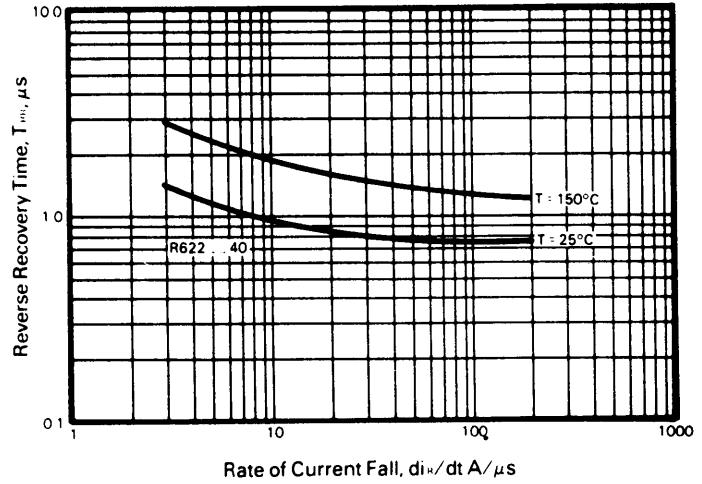

Typical Reverse Recovery Charge Vs. Rate of Current Fall

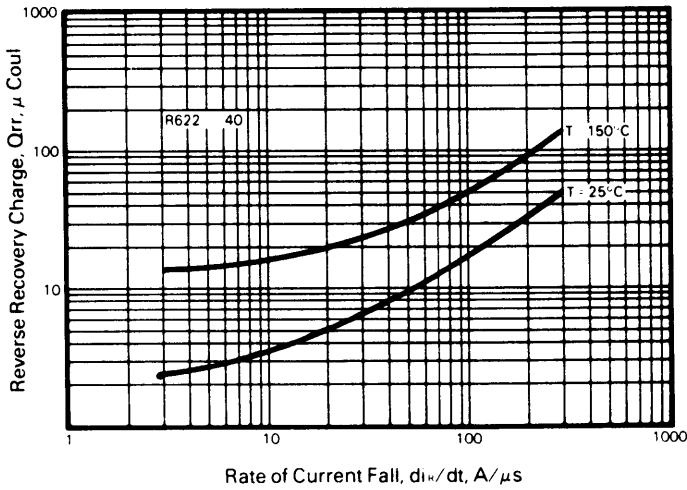

Typical Ratio of Current Recovery to Rate of Current Fall

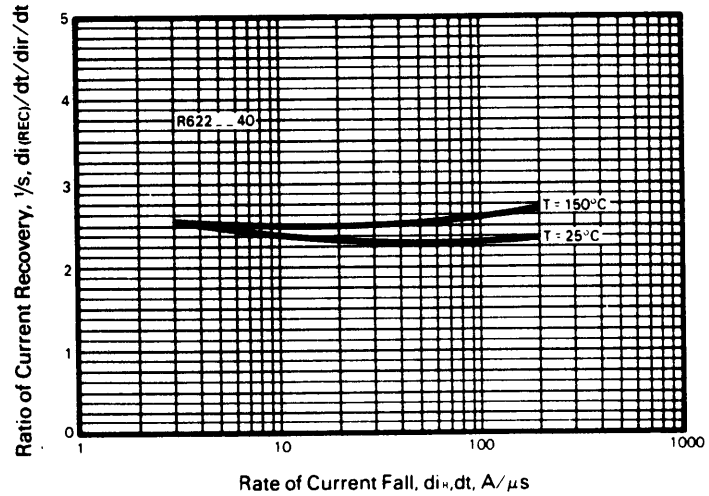

**R622\_40**

**Fast Recovery Rectifier**

400 Amperes Average, 1600 Volts

Forward Current Vs. Forward Voltage Drop

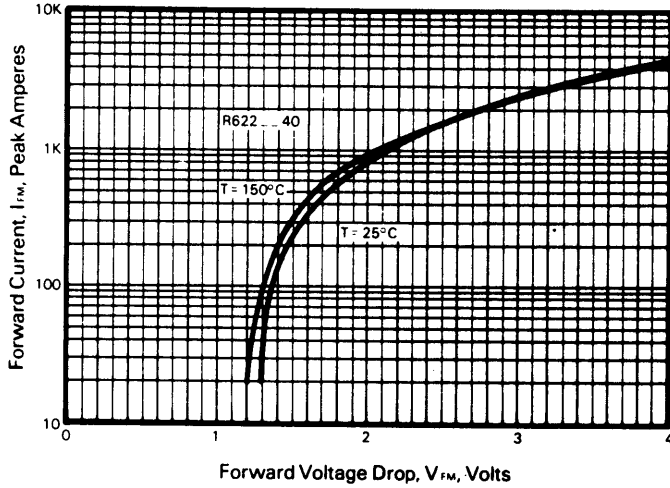

Transient Thermal Impedance Vs. Time

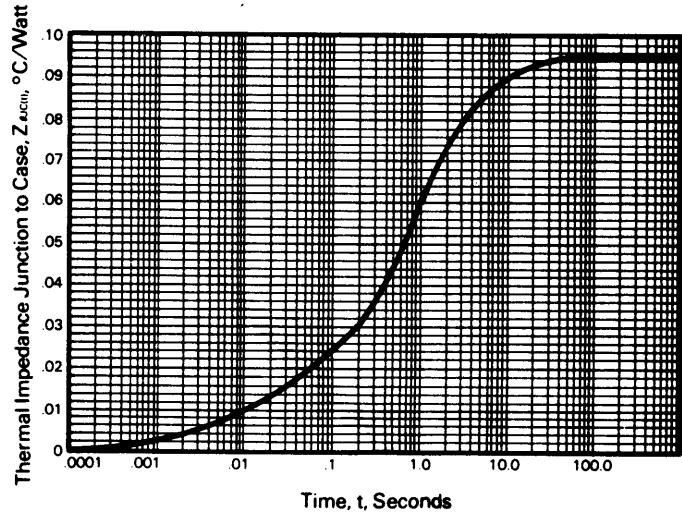

Energy Loss Per Pulse for Sinusoidal Pulses

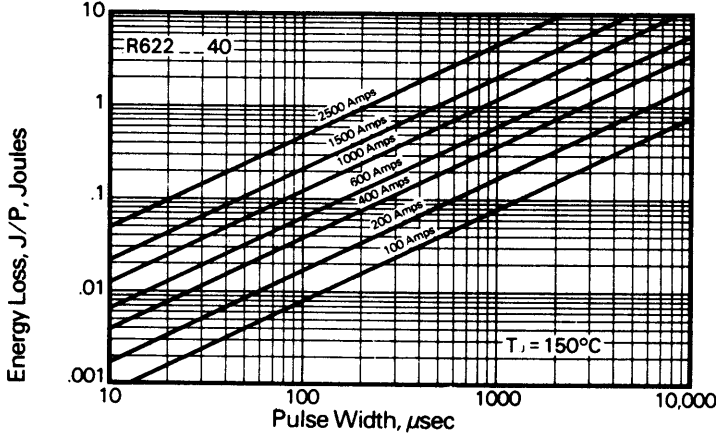

**Calculation of Fast Recovery Diodes and Allowable Case Temperature**

1. Conduction Losses

$$P_{av(cond)} = J/P \times F$$

2. Reverse Recovery Losses (Approximate)

$$P_{av(sw)} = 1/4 \times V_R \times \frac{di_F}{dt} \times T_{rr}^2 \times \left( \frac{1/s}{1 + 1/s} \right)^2 \times F \times 1 \times 10^{-6}$$

3. Maximum Allowable Case Temperature

$$T_{C(max)} = T_j - (P_{av(cond)} + P_{av(sw)}) \times R_{\theta(j-c)}$$

Where:

$P_{av(cond)}$  = Forward Conduction Power Loss in Watts

$P_{av(sw)}$  = Reverse Recovery Power Loss in Watts

$J/P$  = Energy Loss per Pulse in Joules

$F$  = Frequency in Hertz

$V_R$  = Steady State Reverse Operating Voltage in Volts

$di_F/dt$  = Rate of Decay of Forward Current in Amperes/ $\mu\text{sec}$

$T_{rr}$  = Reverse Recovery Time in Microseconds

$\frac{1}{"S"}$  = Ratio of Recovery  $di/dt \left( \frac{di_F/dt}{di_R/dt} \right)$

$F$  = Operating Frequency in Hertz

$T_{C(max)}$  = Maximum Allowable Case Temperature in  $^\circ\text{C}$ .

$T_j$  = Maximum Operating Junction Temperature in  $^\circ\text{C}$ .

$R_{\theta(j-c)}$  = DC Junction to Case Thermal Impedance in  $^\circ\text{C/Watt}$ .