



IGBT Module

SK60GAL123

SK60GAR123

Preliminary Data

Features

- Compact design
- One screw mounting
- Heat transfer and isolation through direct copper bonded aluminium oxide ceramic (DCB)
- N-channel homogeneous silicon structure (NPT-Non punch-through IGBT)
- High short circuit capability
- $V_{ce,sat}$ with positive coefficient
- Low tail current with low temperature dependence

Typical Applications

- Switching (not for linear use)
- Inverter
- Switched mode power supplies
- UPS

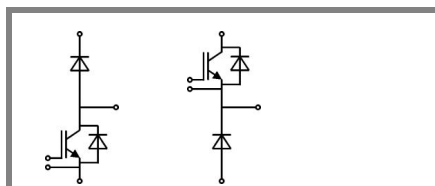

GAL

GAR

Absolute Maximum Ratings		$T_s = 25\text{ }^\circ\text{C}$, unless otherwise specified		
Symbol	Conditions	Values		Units
IGBT				
V_{CES}	$T_j = 25\text{ }^\circ\text{C}$	1200		V
I_C	$T_j = 125\text{ }^\circ\text{C}$	$T_s = 25\text{ }^\circ\text{C}$	58	A
		$T_s = 80\text{ }^\circ\text{C}$	40	A
I_{CRM}	$I_{CRM} = 2 \times I_{Cnom}$	100		A
V_{GES}		± 20		V
t_{psc}	$V_{CC} = 600\text{ V}; V_{GE} \leq 20\text{ V}; T_j = 125\text{ }^\circ\text{C}$ $V_{CES} < 1200\text{ V}$	10		μs
Inverse Diode				
I_F	$T_j = 150\text{ }^\circ\text{C}$	$T_s = 25\text{ }^\circ\text{C}$	33	A
		$T_s = 80\text{ }^\circ\text{C}$	23	A
I_{FRM}	$I_{FRM} = 2 \times I_{Fnom}$			A
I_{FSM}	$t_p = 10\text{ ms};$ half sine wave $T_j = 150\text{ }^\circ\text{C}$	110		A
Freewheeling Diode				
I_F	$T_j = 150\text{ }^\circ\text{C}$	$T_{case} = 25\text{ }^\circ\text{C}$	57	A
		$T_{case} = 80\text{ }^\circ\text{C}$	38	A
I_{FRM}				A
I_{FSM}	$t_p = 10\text{ ms};$ half sine wave $T_j = 150\text{ }^\circ\text{C}$	550		A
Module				
$I_{t(RMS)}$				A
T_{vj}		-40 ... +150		$^\circ\text{C}$
T_{stg}		-40 ... +125		$^\circ\text{C}$
V_{isol}	AC, 1 min.	2500		V

Characteristics		$T_s = 25\text{ }^\circ\text{C}$, unless otherwise specified			
Symbol	Conditions	min.	typ.	max.	Units
IGBT					
$V_{GE(th)}$	$V_{GE} = V_{CE}, I_C = 2\text{ mA}$	4,5	5,5	6,5	V
I_{CES}	$V_{GE} = 0\text{ V}, V_{CE} = V_{CES}$	$T_j = 25\text{ }^\circ\text{C}$	0,3		mA
		$T_j = 125\text{ }^\circ\text{C}$			mA
I_{GES}	$V_{CE} = 0\text{ V}, V_{GE} = 30\text{ V}$	$T_j = 25\text{ }^\circ\text{C}$	300		nA
V_{CE0}		$T_j = 25\text{ }^\circ\text{C}$	1,2		V
		$T_j = 125\text{ }^\circ\text{C}$	1,2		V
r_{CE}	$V_{GE} = 15\text{ V}$	$T_j = 25\text{ }^\circ\text{C}$	26		m Ω
		$T_j = 125\text{ }^\circ\text{C}$	38		m Ω
$V_{CE(sat)}$	$I_{Cnom} = 50\text{ A}, V_{GE} = 15\text{ V}$	$T_j = 25\text{ }^\circ\text{C}_{chiplev.}$	2,5	3	V
		$T_j = 125\text{ }^\circ\text{C}_{chiplev.}$	3,1	3,7	V
C_{ies}	$V_{CE} = 25, V_{GE} = 0\text{ V}$	$f = 1\text{ MHz}$	3,3		nF
C_{oes}			0,5		nF
C_{res}			0,22		nF
Q_G	$V_{GE} = 0 \dots 20\text{ V}$	285		nC	
$t_{d(on)}$	$R_{Gon} = 22\text{ }^\circ\Omega$	$V_{CC} = 600\text{ V}$ $I_{Cnom} = 50\text{ A}$	70		ns
t_r			90		ns
E_{on}	$R_{Goff} = 22\text{ }^\circ\Omega$	$T_j = 125\text{ }^\circ\text{C}$ $V_{GE} = \pm 15\text{ V}$	9,9		mJ
$t_{d(off)}$			460		ns
t_f			30		ns
E_{off}			5,3		mJ
$R_{th(j-s)}$	per IGBT	0,6		K/W	

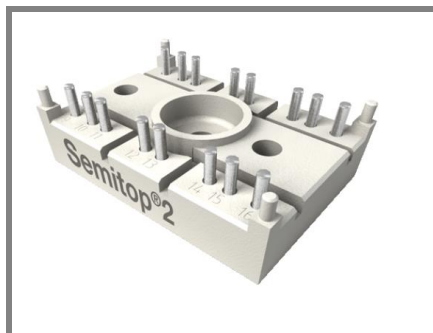

SEMITOP[®] 2

IGBT Module

SK60GAL123

SK60GAR123

Preliminary Data

Features

- Compact design
- One screw mounting
- Heat transfer and isolation through direct copper bonded aluminium oxide ceramic (DCB)
- N-channel homogeneous silicon structure (NPT-Non punch-through IGBT)
- High short circuit capability
- $V_{ce,sat}$ with positive coefficient
- Low tail current with low temperature dependence

Typical Applications

- Switching (not for linear use)
- Inverter
- Switched mode power supplies
- UPS

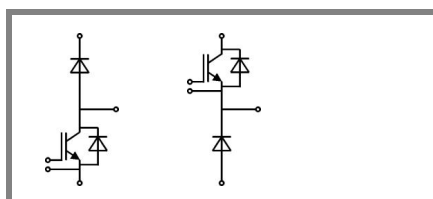

GAL

GAR

Characteristics

Symbol	Conditions	min.	typ.	max.	Units
Inverse Diode					
$V_F = V_{EC}$	$I_{Fnom} = 10 \text{ A}; V_{GE} = 0 \text{ V}$		2	2,5	V
			1,8	2,3	V
					V
V_{F0}			1	1,2	V
r_F			80		mΩ
I_{RRM}	$I_{Fnom} = 10 \text{ A}$		12		A
Q_{rr}	$di/dt = -300 \text{ A}/\mu\text{s}$		1,8		μC
E_{rr}	$V_{CC} = 600 \text{ V}$		0,4		mJ
$R_{th(j-s)D}$	per diode			2,1	K/W
Freewheeling Diode					
$V_F = V_{EC}$	$I_{Fnom} = 50 \text{ A}; V_{GE} = 0 \text{ V}$		1	2,5	V
			1,8		V
					V
V_{F0}			1	1,2	V
r_F			18	22	V
I_{RRM}	$I_{Fnom} = 50 \text{ A}$		40		A
Q_{rr}	$di/dt = -800 \text{ A}/\mu\text{s}$		8		μC
E_{rr}	$V_R = 600 \text{ V}$		2,3		mJ
$R_{th(j-s)FD}$	per diode			0,9	K/W
M_s	to heat sink M1			2	Nm
w			21		g

This is an electrostatic discharge sensitive device (ESDS), international standard IEC 60747-1, Chapter IX.

This technical information specifies semiconductor devices but promises no characteristics. No warranty or guarantee expressed or implied is made regarding delivery, performance or suitability.

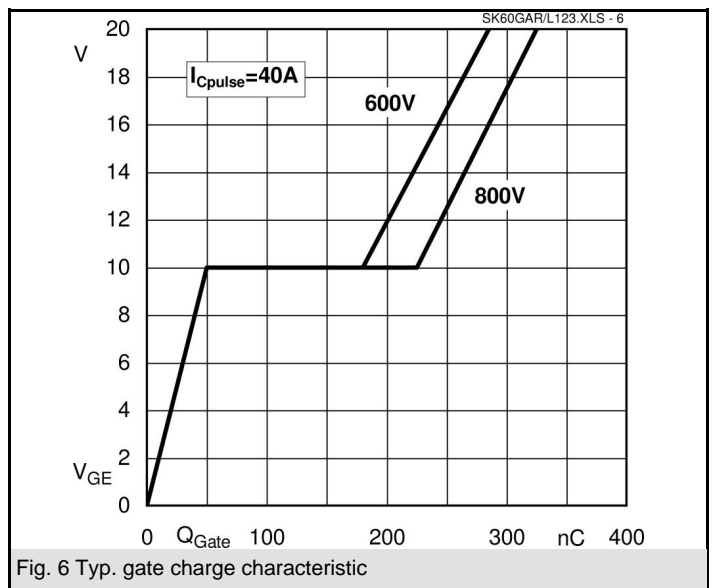
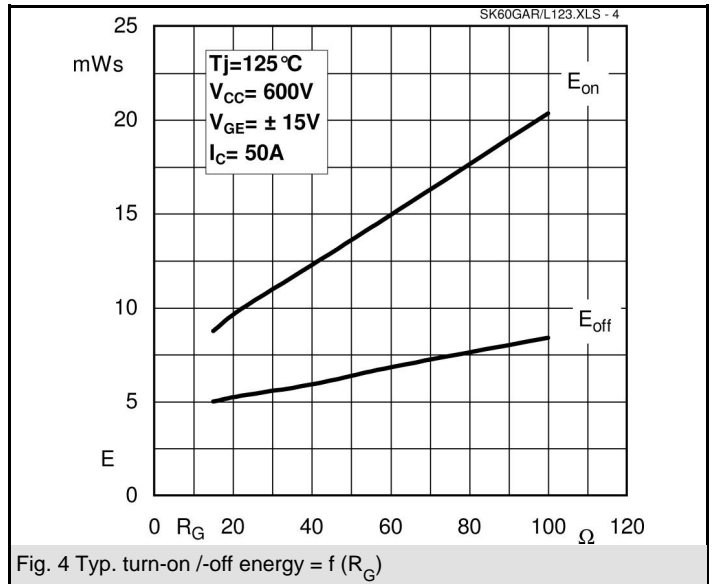
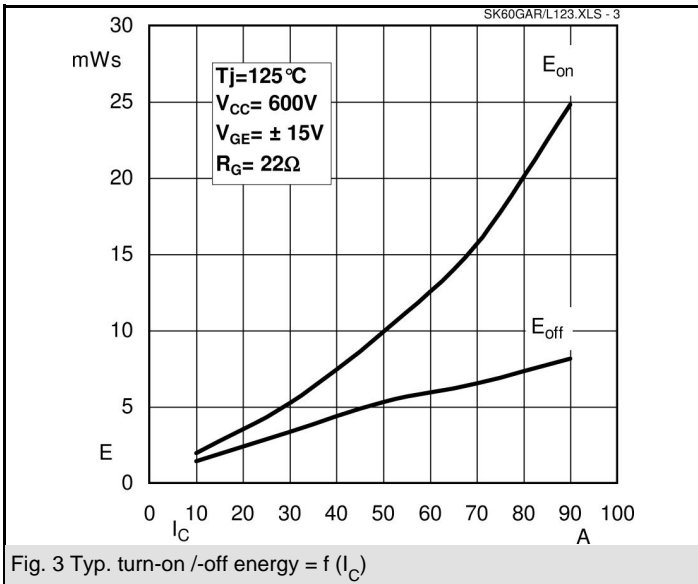
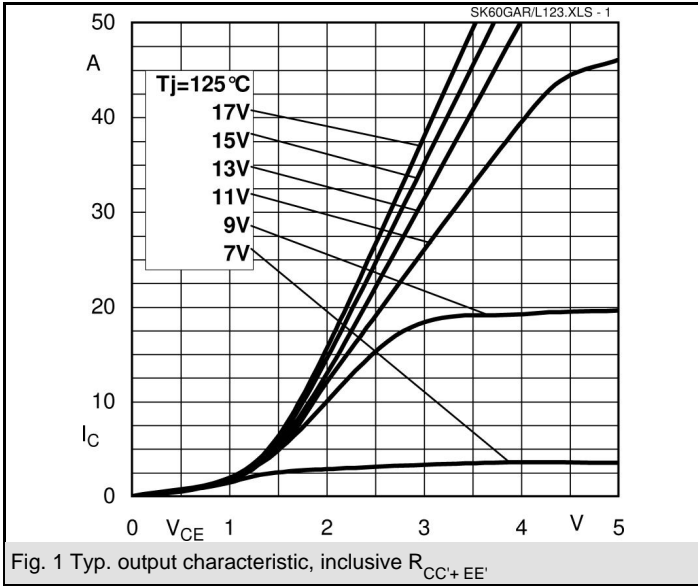

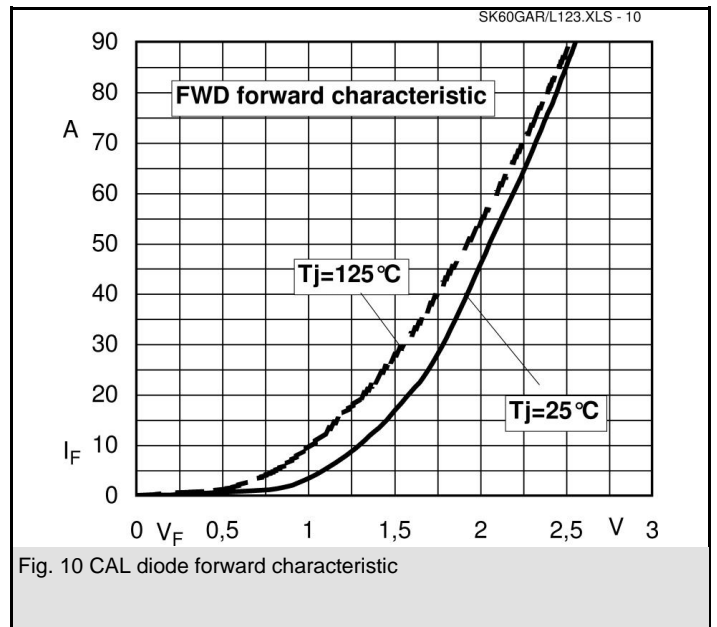
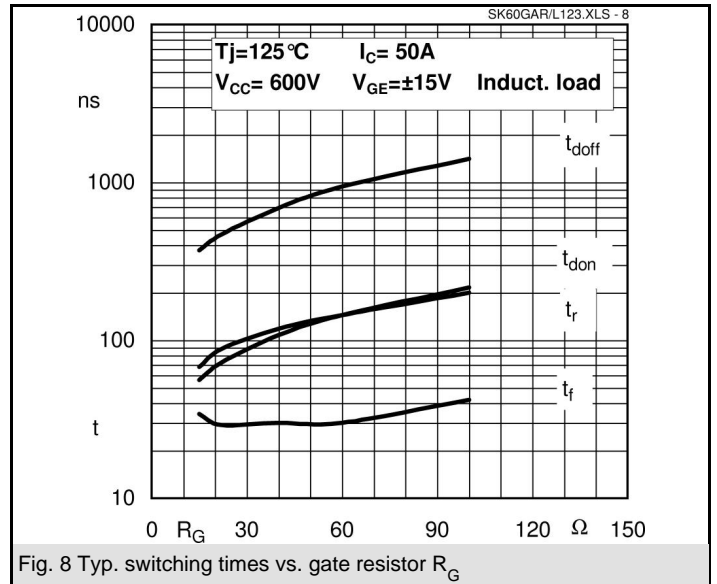
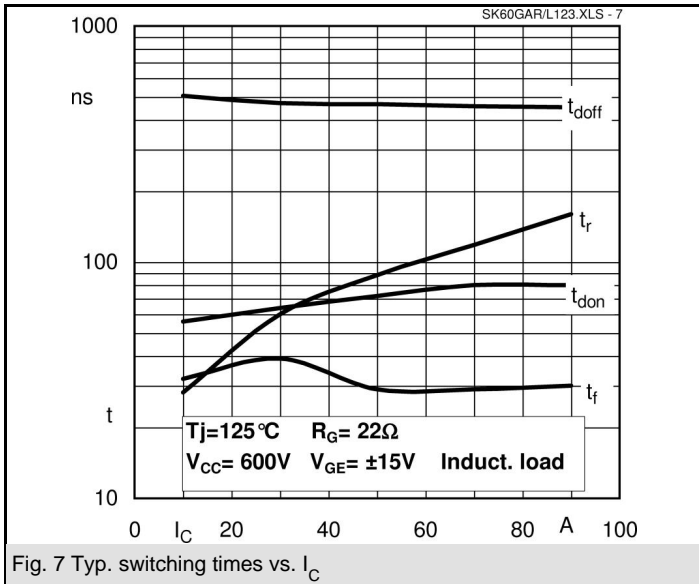

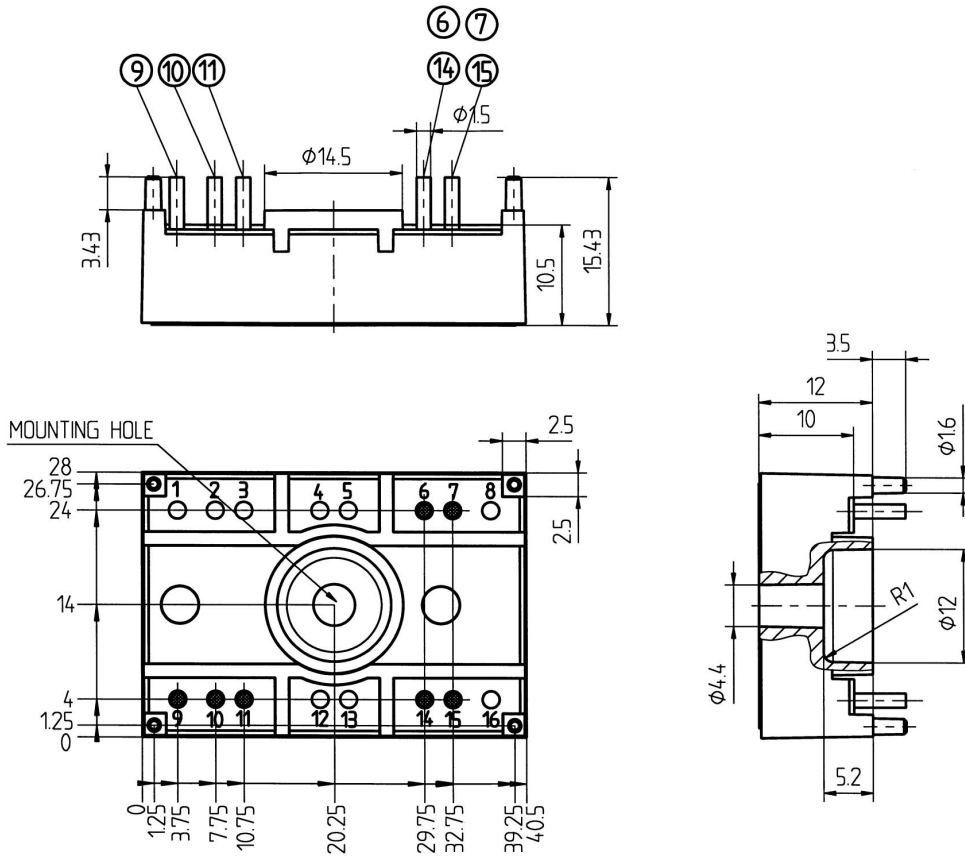

Case T18 (Suggested hole diameter, in the PCB, for solder pins and plastic mounting pins: 2mm)

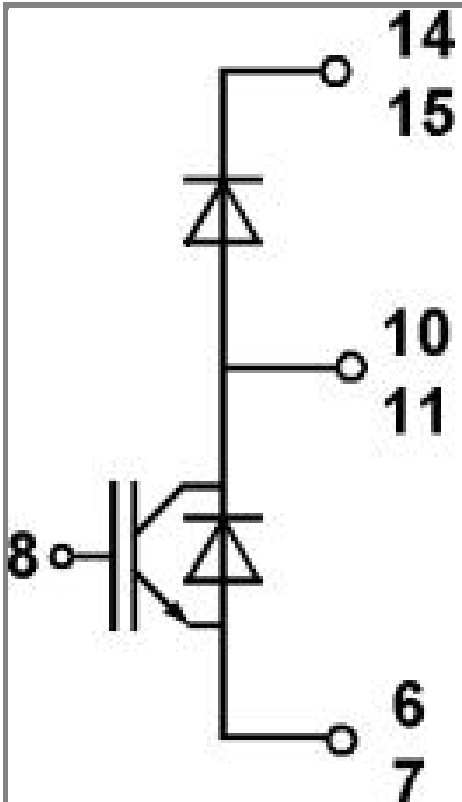

Case T18

GAL

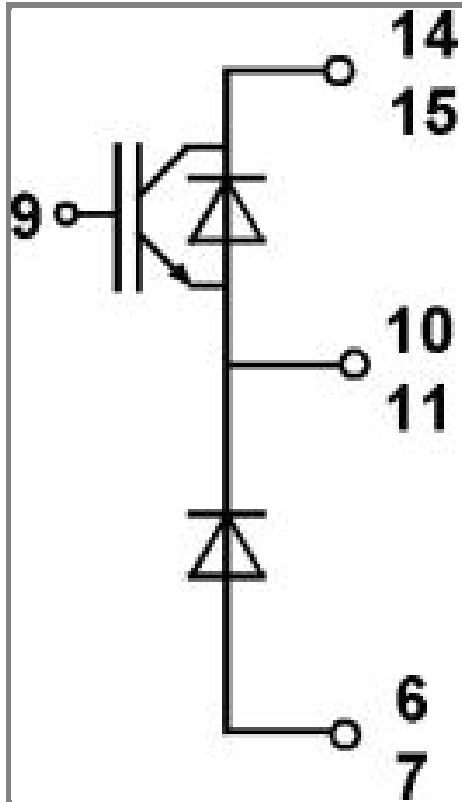

Case T18

GAR