

# SK 70 DT

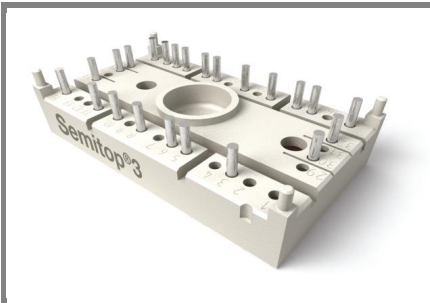

**SEMITOP® 3**

## Controlled Bridge Rectifier

### SK 70 DT

Preliminary Data

### Features

- Compact design
- One screw mounting
- Heat transfer and insulation through direct copper bonded aluminium oxide ceramic (DBC)
- Glass passivated thyristor chips
- Up to 1600V reverse voltage
- UL recognized, file no. E 63 532

### Typical Applications

- Soft starters
- Light control
- Temperature control
- Motor control

$V_{RSM}$ V	$V_{RRM}, V_{DRM}$ V	$I_D = 68 \text{ A (full conduction)}$ ( $T_s = 80 \text{ °C}$ )
900	800	SK 70 DT 08
1300	1200	SK 70 DT 12
1700	1600	SK 70 DT 16

Symbol	Conditions	Values	Units
$I_D$	$T_s = 80 \text{ °C}$	68	A
$I_{TSM}$	$T_{vj} = 25 \text{ °C}; 10 \text{ ms}$ $T_{vj} = 125 \text{ °C}; 10 \text{ ms}$	450 380	A A
$i^2t$	$T_{vj} = 25 \text{ °C}; 8,3 \dots 10 \text{ ms}$ $T_{vj} = 125 \text{ °C}; 8,3 \dots 10 \text{ ms}$	1000 720	$A^2s$ $A^2s$
$V_T$	$T_{vj} = 25 \text{ °C}; 75A$	max. 1,9	V
$V_{T(TO)}$	$T_{vj} = 125 \text{ °C};$	max. 1	V
$r_T$	$T_{vj} = 125 \text{ °C}$	max. 10	$m\Omega$
$I_{DD}, I_{RD}$	$T_{vj} = 125 \text{ °C}; V_{DD} = V_{DRM}; V_{RD} = V_{RRM}$	max. 10	mA
$t_{gd}$	$T_{vj} = 25 \text{ °C}; I_G = 1 \text{ A}; di_G/dt = 1 \text{ A}/\mu s$	1	$\mu s$
$t_{gr}$	$V_D = 0,67 \cdot V_{DRM}$	2	$\mu s$
$(dv/dt)_{cr}$	$T_{vj} = 125 \text{ °C}$	max. 1000	$V/\mu s$
$(di/dt)_{cr}$	$T_{vj} = 125 \text{ °C}; f = 50 \dots 60 \text{ Hz}$	max. 50	$A/\mu s$
$t_q$	$T_{vj} = 125 \text{ °C}; \text{typ.}$	80	$\mu s$
$I_H$	$T_{vj} = 25 \text{ °C}; \text{typ. / max.}$	80 / 150	mA
$I_L$	$T_{vj} = 25 \text{ °C}; R_G = 33 \Omega$	150 / 300	mA
$V_{GT}$	$T_{vj} = 25 \text{ °C}; \text{d.c.}$	min. 2	V
$I_{GT}$	$T_{vj} = 25 \text{ °C}; \text{d.c.}$	min. 100	mA
$V_{GD}$	$T_{vj} = 125 \text{ °C}; \text{d.c.}$	max. 0,25	V
$I_{GD}$	$T_{vj} = 125 \text{ °C}; \text{d.c.}$	max. 3	mA
$R_{th(j-s)}$	Per thyristor	1,2	K/W
$T_{solder}$	Terminals, 10s	260	$^{\circ}C$
$T_{vj}$		-40...+125	$^{\circ}C$
$T_{stg}$		-40...+125	$^{\circ}C$
$V_{isol}$	a. c. 50 Hz; r.m.s.; 1 s / 1 min.	3000 ( 2500 )	V
$M_s$	Mounting torque to heatsink	2,5	Nm
m	weight	30	g
Case	SEMITOP® 3	T 15	

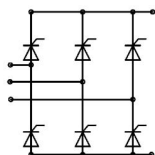

DT

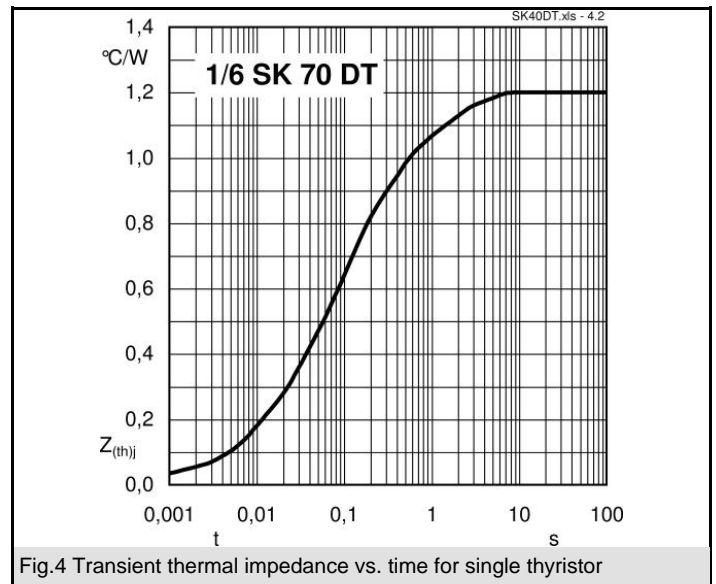
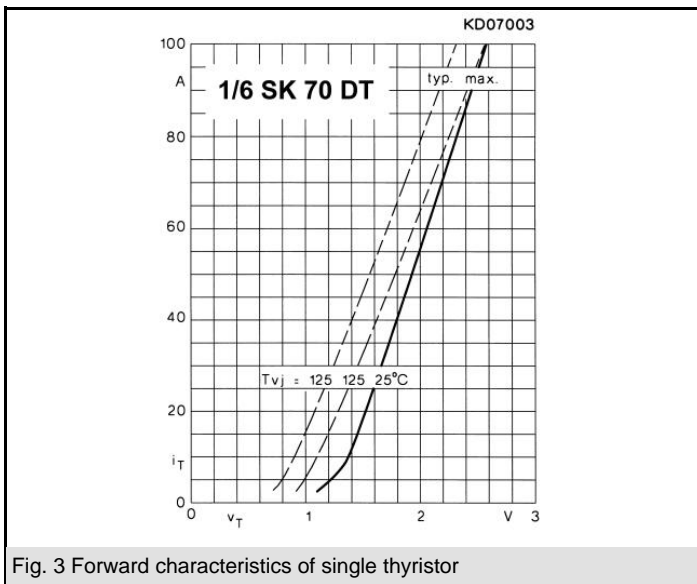
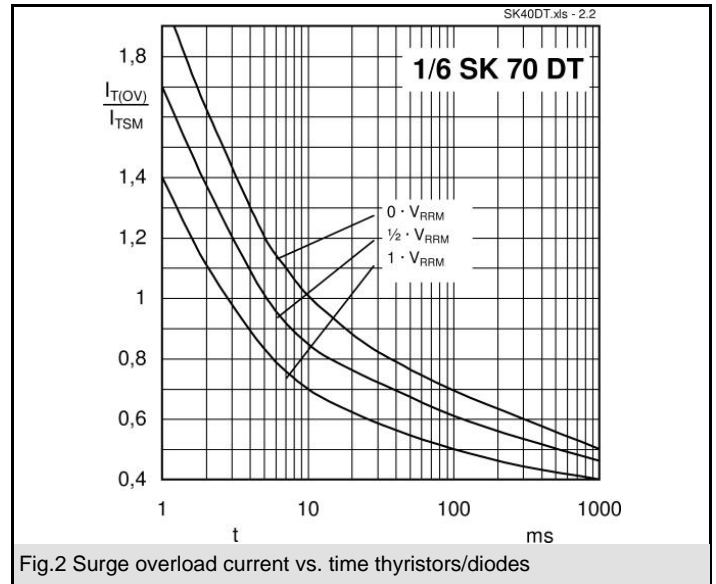
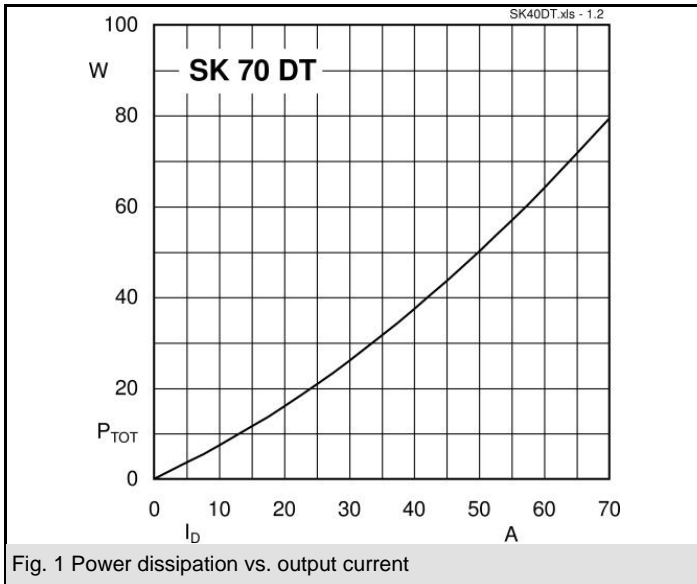

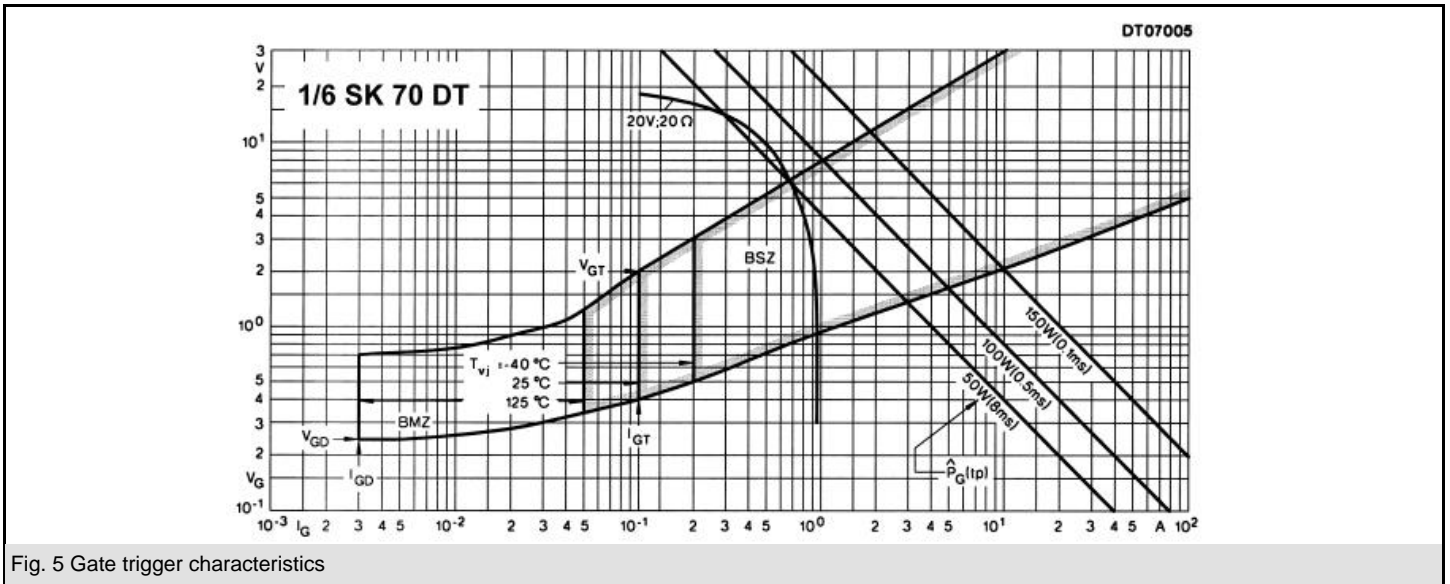
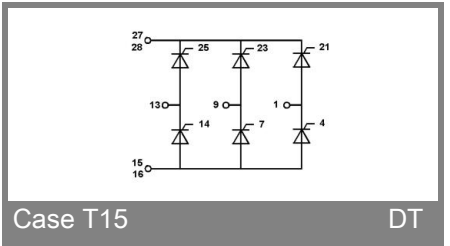
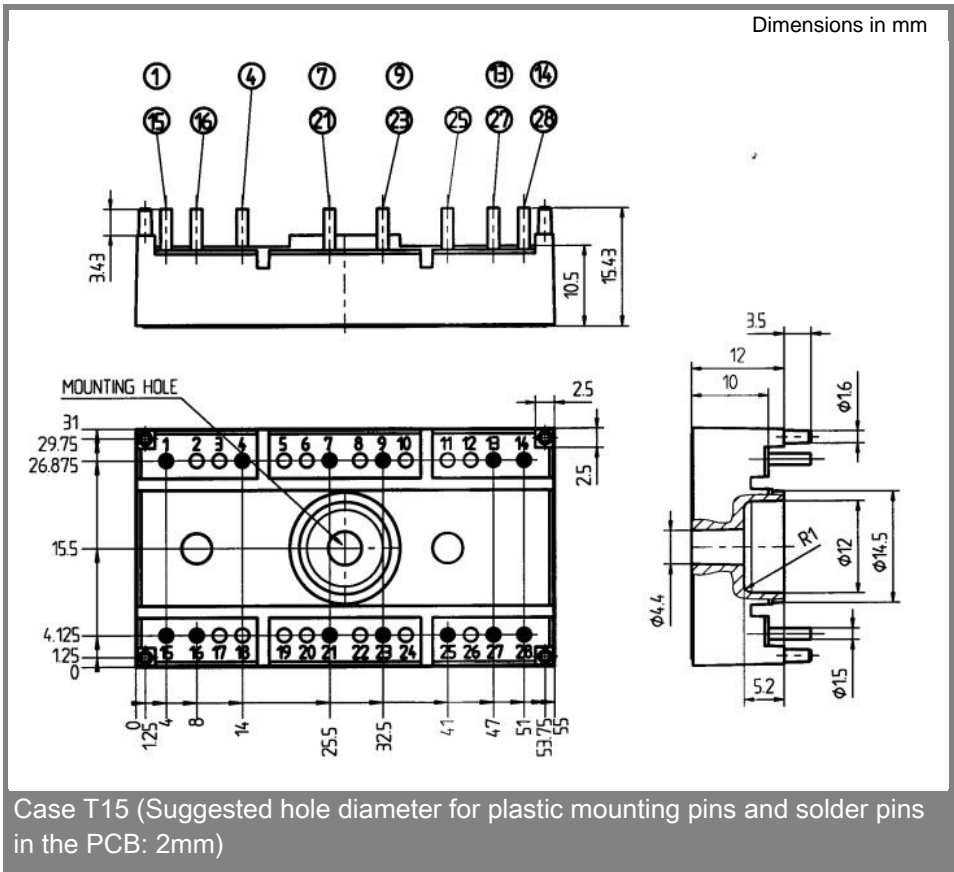

Fig. 5 Gate trigger characteristics



This technical information specifies semiconductor devices but promises no characteristics. No warranty or guarantee expressed or implied is made regarding delivery, performance or suitability.