

Absolute Maximum Ratings

| Symbol | Conditions ¹⁾ | Values | | Units |
|-------------------------------------|-------------------------------------|---------------|-----------|-------|
| | | ... 101 D | ... 121 D | |
| V _{CES} | | 1000 | 1200 | V |
| V _{CGR} | R _{GE} = 20 kΩ | 1000 | 1200 | V |
| I _C | T _{case} = 25/80 °C | 150/100 | | A |
| I _{CM} | T _{case} = 25/80 °C | 300/200 | | A |
| V _{GES} | | ± 20 | | V |
| P _{tot} | per IGBT, T _{case} = 25 °C | 1000 | | W |
| T _J , T _{stg} | | - 55 ... +150 | | °C |
| V _{isol} | AC, 1 min | 2 500 | | V |
| humidity | DIN 40 040 | Class F | | |
| climate | DIN IEC 68 T.1 | 55/150/56 | | |
| Inverse Diode | | | | |
| I _F = - I _C | | 150 | | A |
| I _{FM} = - I _{CM} | | 300 | | A |

Characteristics

| Symbol | Conditions ¹⁾ | | | | Units |
|----------------------------------|--|--------------------|-------------------------------------|-------|-------|
| | | min. | typ. | max. | |
| V _{(BR)CES} | V _{GE} = 0, I _C = 2 mA | ≥ V _{CES} | - | - | V |
| V _{GE(th)} | V _{GE} = V _{CE} , I _C = 8 mA | 4,5 | 5,5 | 6,5 | V |
| I _{CES} | V _{GE} = 0 | - | - | 2 | mA |
| | V _{CE} = V _{CES} } T _J = 25 °C | - | - | 8 | mA |
| | | - | - | 100 | nA |
| I _{GES} | V _{GE} = 20 V, V _{CE} = 0 | - | - | 100 | nA |
| V _{CEsat} | V _{GE} = 15 V } T _J = 25 °C | - | 3,5 | 4 | V |
| | I _C = 150 A } T _J = 150 °C | - | 4 | 5 | V |
| g _{is} | V _{CE} = 20 V, I _C = 150 A | 44 | 64 | - | S |
| C _{CHC} | per IGBT | - | - | 200 | pF |
| C _{ies} | V _{GE} = 0 | - | 16 | - | nF |
| C _{oes} | V _{CE} = 25 V | - | 1300 | - | pF |
| C _{res} | f = 1 MHz | - | 500 | - | pF |
| L _{CE} | | - | - | 80 | nH |
| t _{d(on)} | V _{CC} = 600 V | - | 150 ³⁾ | - | ns |
| t _r | V _{GE} = 15 V | - | 350 ³⁾ | - | ns |
| t _{d(off)} | I _C = 150 A | - | 700 ^{3)/700 ⁴⁾} | - | ns |
| t _f | R _{Gon} = R _{Goff} = 3,3 Ω | - | 450 ^{3)/100 ⁴⁾} | - | ns |
| W _{off12} ⁵⁾ | T _J = 125 °C | - | 15 ⁴⁾ | - | mWs |
| W _{off23} ⁵⁾ | | - | 8 ⁴⁾ | - | mWs |
| Inverse Diode ...101 D, ...102 D | | | | | |
| V _F = V _{EC} | I _F = 150 A, V _{GE} = 0; (T _J = 125 °C) | - | 2,1 (1,9) | 2,8 | V |
| t _{rr} | T _J = 25 °C ²⁾ | - | - | - | ns |
| | T _J = 125 °C ²⁾ | - | 300 | - | ns |
| Q _{rr} | T _J = 25/125 °C ²⁾ | - | 4/18 | - | μC |
| f _s | f _s = t _r / (t _{rr} - t _r) | - | 1 ²⁾ | - | |
| Inverse Diode ...121 D, ...122 D | | | | | |
| V _F = V _{EC} | I _F = 150 A, V _{GE} = 0; (T _J = 125 °C) | - | 2,7 (2,1) | 3,2 | V |
| t _{rr} | T _J = 25 °C ²⁾ | - | - | - | ns |
| | T _J = 125 °C ²⁾ | - | 350 | - | ns |
| Q _{rr} | T _J = 25/125 °C ²⁾ | - | 5/20 | - | μC |
| f _s | f _s = t _r / (t _{rr} - t _r) | - | 1 ²⁾ | - | |
| Thermal Characteristics | | | | | |
| R _{thjc} | per IGBT | - | - | 0,13 | °C/W |
| R _{thjc} | per diode | - | - | 0,5 | °C/W |
| R _{thch} | per module | - | - | 0,038 | °C/W |

Cases and mechanical data see page B 6 – 126

SEMITRANS® M IGBT Modules

SKM 150 GB 101 D, 102 D
SKM 150 GAL 101D, 102 D ⁶⁾
SKM 150 GAR 101 D ⁶⁾
SKM 150 GB 121 D, 122 D
SKM 150 GAL 121 D, 122 D ⁶⁾
SKM 150 GAR 121 D, 122 D ⁶⁾

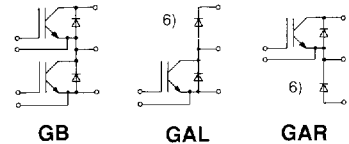
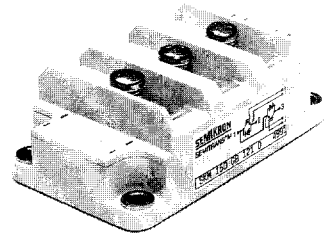

Features

- MOS input (voltage controlled)
- N channel
- Low saturation voltage
- Very low tail current
- Low temperature sensitivity
- High short circuit capability
- No latch-up
- Fast inverse diodes
- Isolated copper baseplate
- Large clearances and creepage distances
- UL recognized, file no. E 63 532

Typical Applications

→ page B 6 – 103

¹⁾ T_{case} = 25 °C, unless otherwise specified

²⁾ I_F = - I_C, V_R = 600 V, - di_F/dt = 800 A/μs, V_{GE} = 0

³⁾ resistive load

⁴⁾ inductive load

⁵⁾ see fig. 21; R_{Goff} = 4 Ω

⁶⁾ The free-wheeling diodes of the GAL and GAR types have the data of the inverse diodes of SKM 200 ...

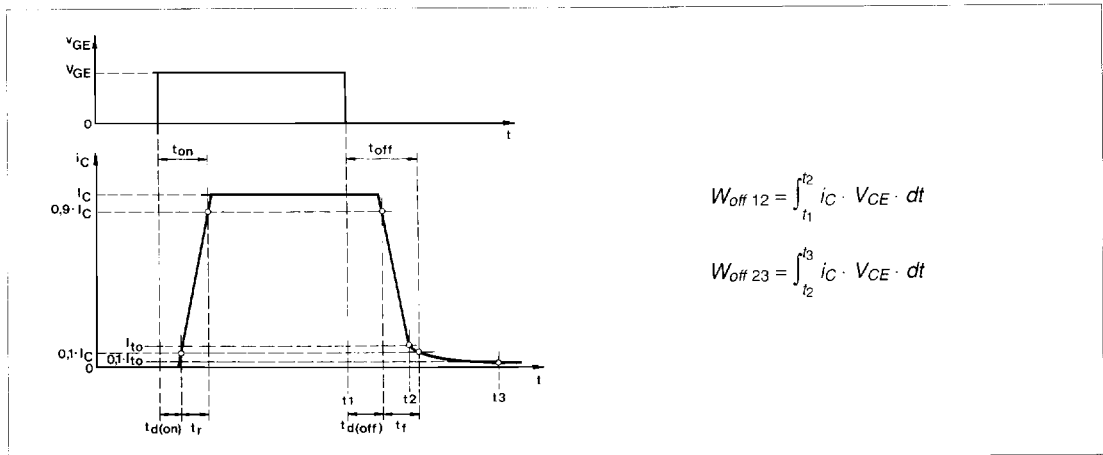

Fig. 21 Switching times and turn-off energies

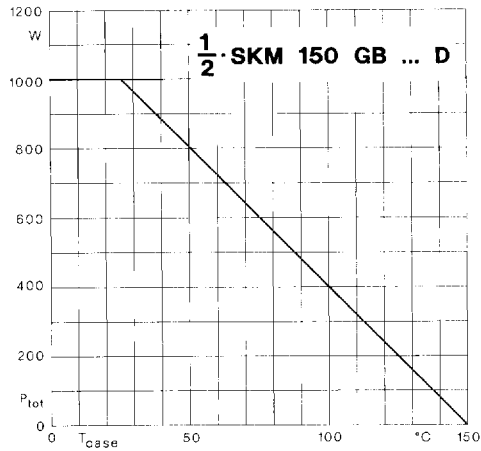

Fig. 22 Rated power dissipation vs. temperature

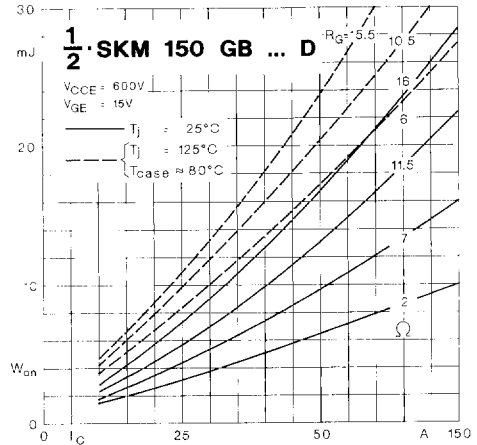

Fig. 23 Turn-on energy dissipation per pulse

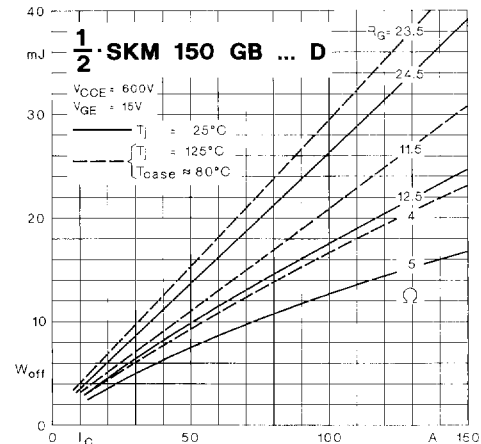

Fig. 24 Turn-off energy dissipation per pulse

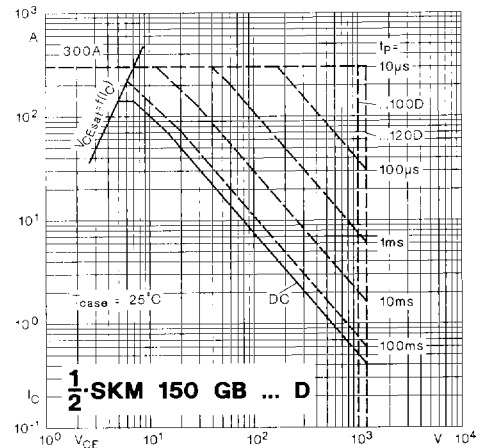

Fig. 25 Maximum safe operating area

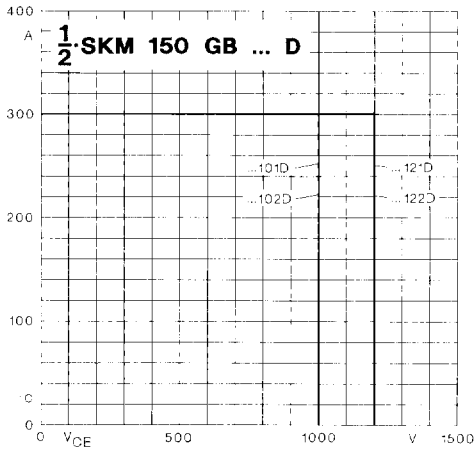

Fig. 26 Turn-off safe operating area

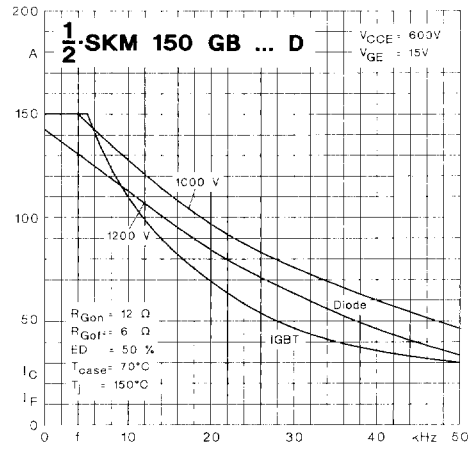

Fig. 27 Rated current vs. pulse frequency

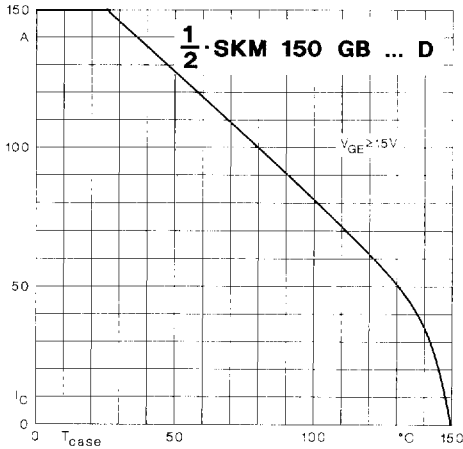

Fig. 28 Rated current vs. temperature

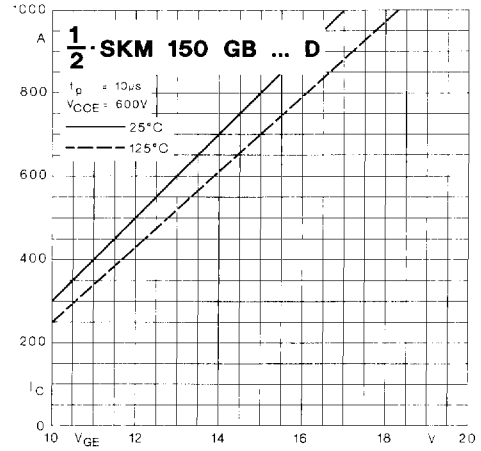

Fig. 29 Short-circuit current vs. turn-on gate voltage

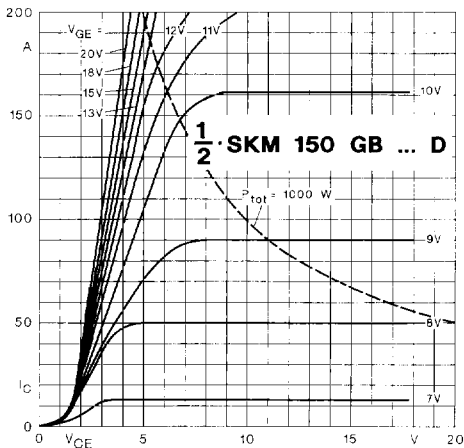

Fig. 30 Output characteristic

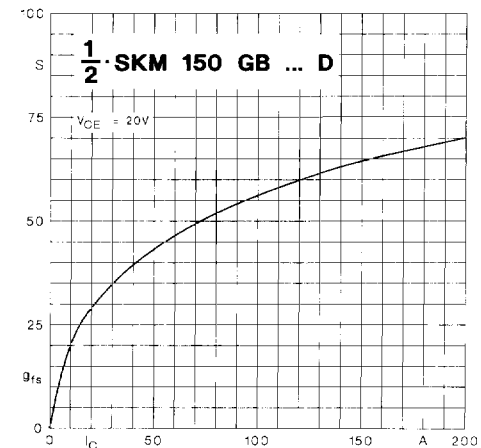

Fig. 31 Forward transconductance

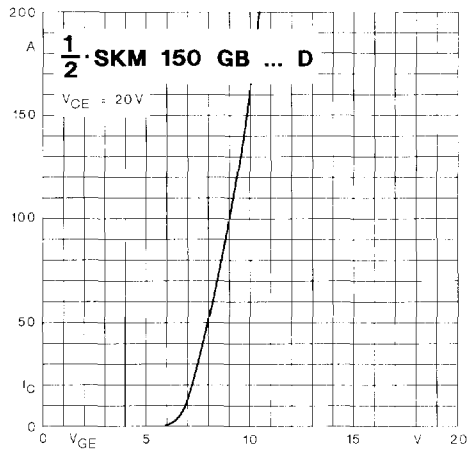

Fig. 32 Transfer characteristic

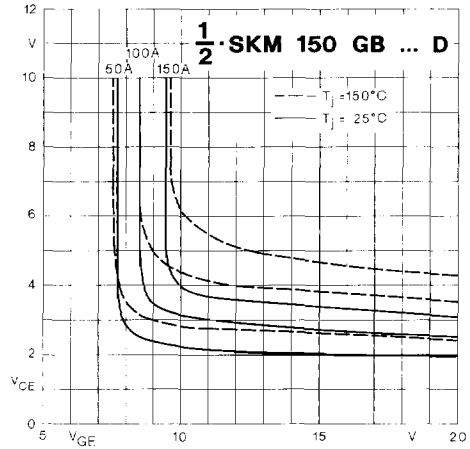

Fig. 33 Saturation characteristics

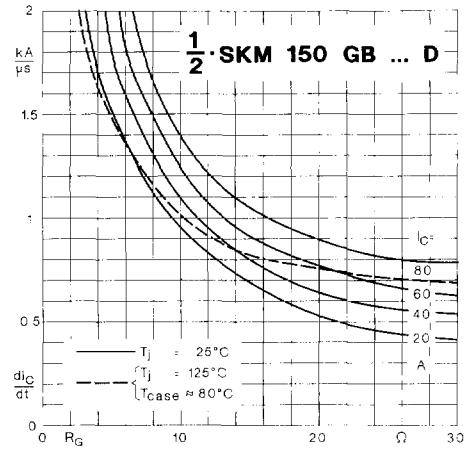

Fig. 34 Rate of rise of collector current

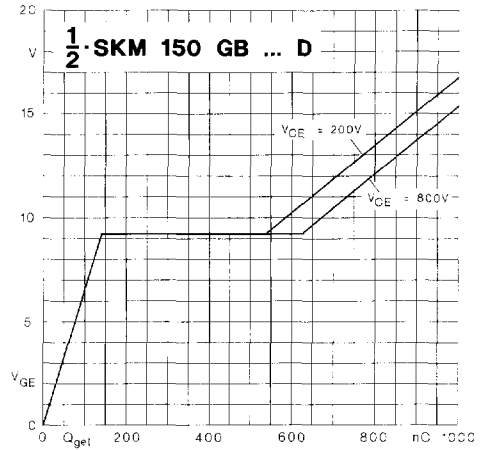

Fig. 35 Gate charge characteristic

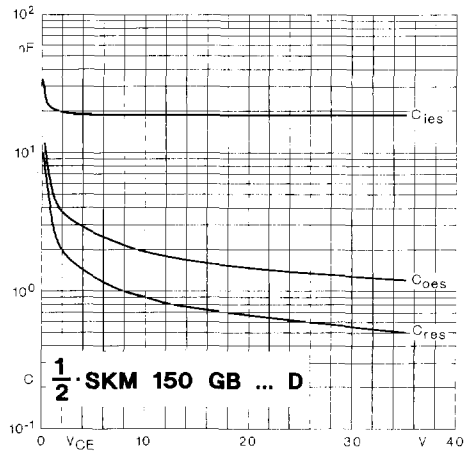

Fig. 36 Capacitances vs. collector-emitter voltage

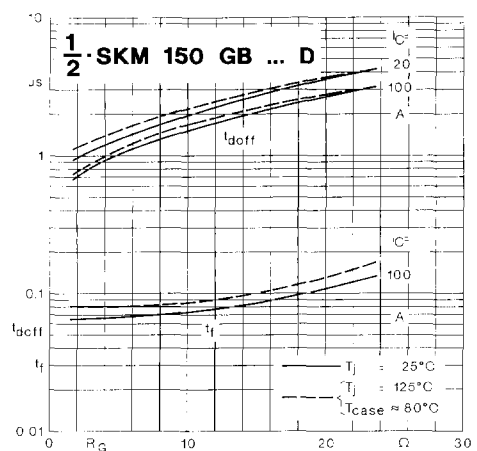

Fig. 37 Switching times vs. gate resistor

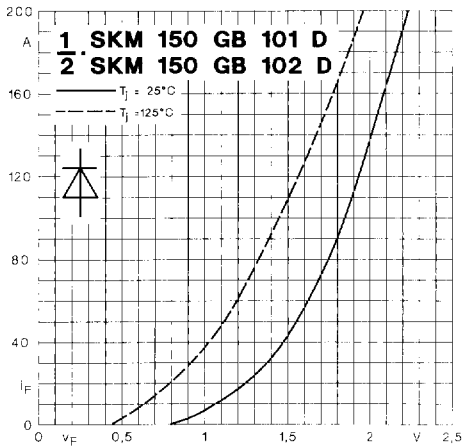

Fig. 38 a Diode forward characteristic

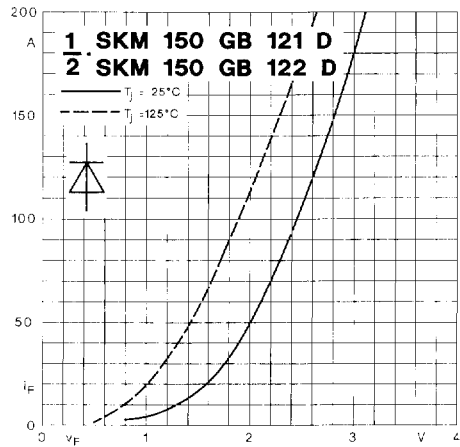

Fig. 38 b Diode forward characteristic

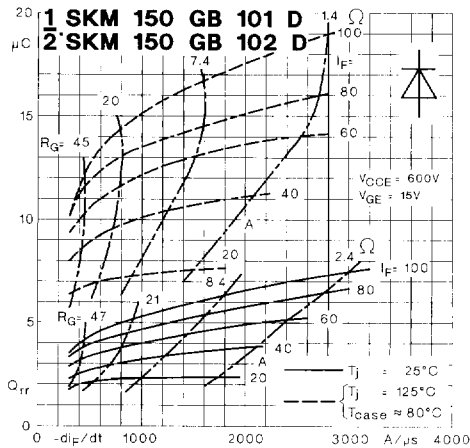

Fig. 39 a Diode recovered charge

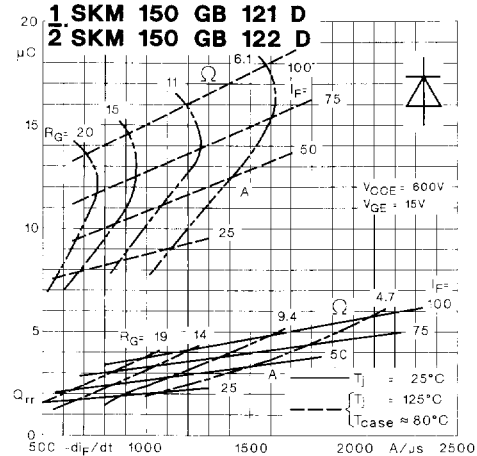

Fig. 39 b Diode recovered charge

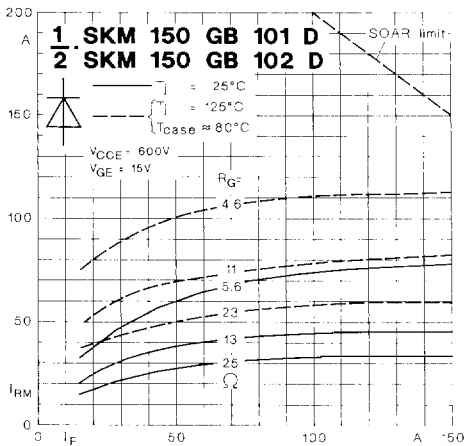

Fig. 40 a Diode peak reverse recovery current (I_{RM})

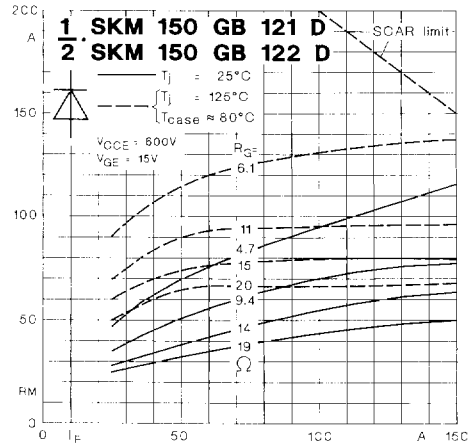

Fig. 40 b Diode peak reverse recovery current (I_{RM})

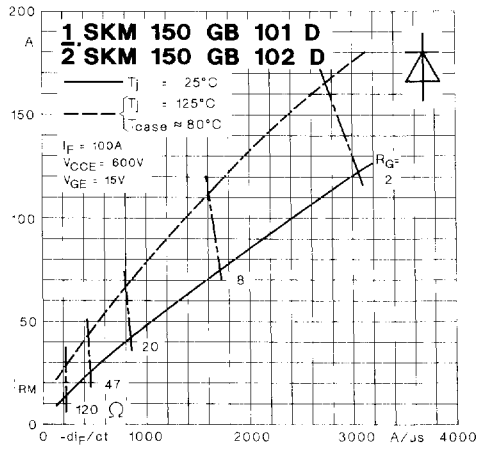

Fig. 41 a Diode peak reverse recovery current ($-di_F/dt$)

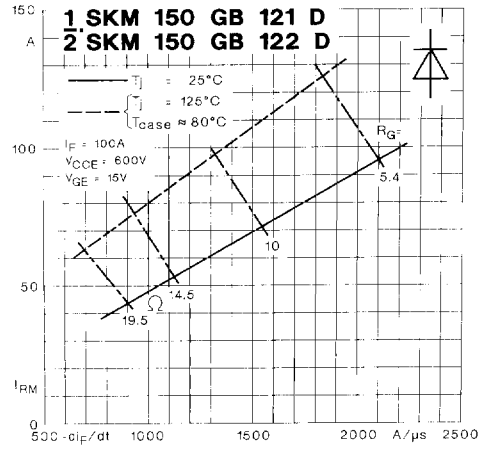

Fig. 41 b Diode peak reverse recovery current ($-di_F/dt$)

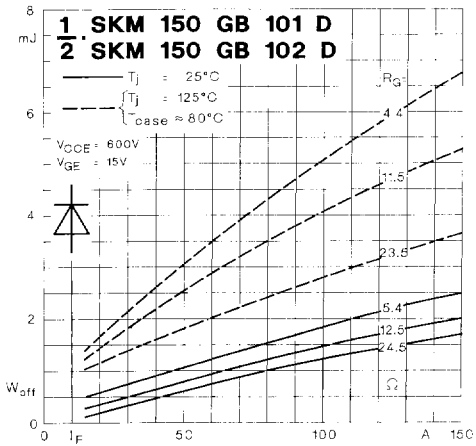

Fig. 42 a Diode turn-off energy dissipation per pulse

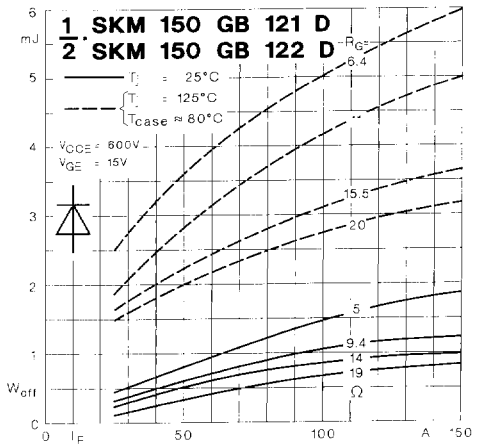

Fig. 42 b Diode turn-off energy dissipation per pulse

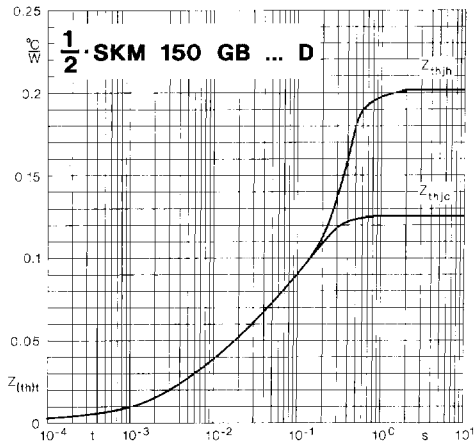

Fig. 51 Transient thermal impedance

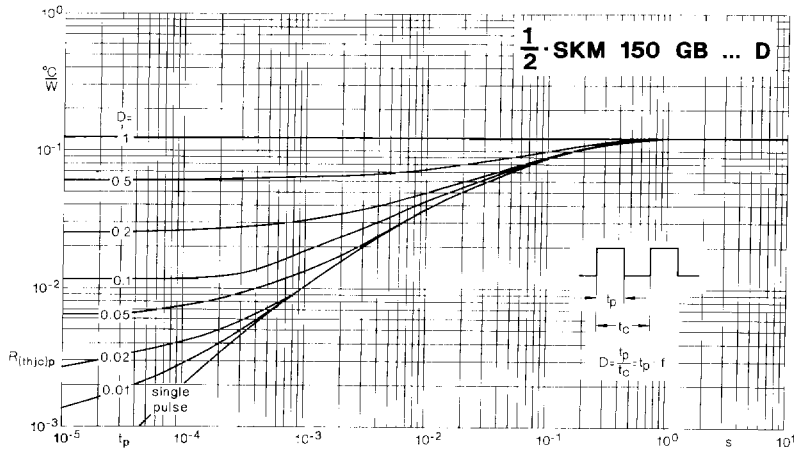

Fig. 52 Thermal impedance under pulse conditions

SKM 150 GB 101 D

SKM 150 GB 121 D

Case D 31

UL recognized,

file no. E 63 532

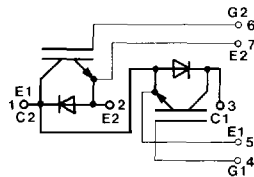
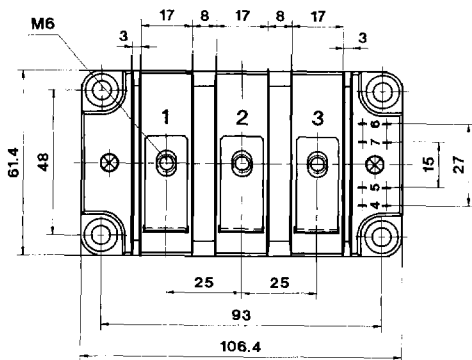
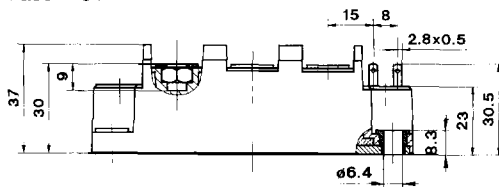

SKM 150 GB 102 D

SKM 150 GB 122 D

Case D 42

UL recognized,

file no. E 63 532

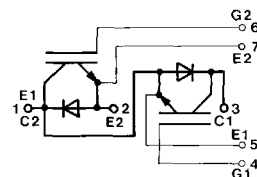
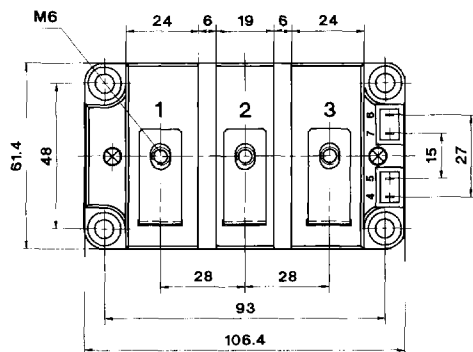
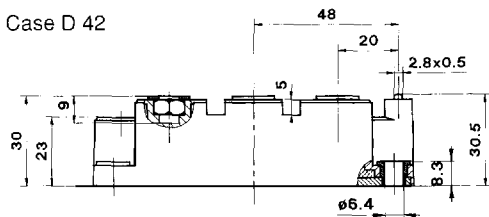

SKM 150 GAL 101 D

SKM 150 GAL 121 D

Case D 35 (→ D 31)

SKM 150 GAL 102 D

SKM 150 GAL 122 D

Case D 43 (→ D 42)

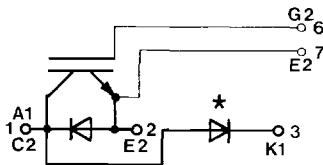

SKM 150 GAR 101 D

SKM 150 GAR 121 D

Case D 36 (→ D 31)

SKM 150 GAR 122 D

Case D 44 (→ D 42)

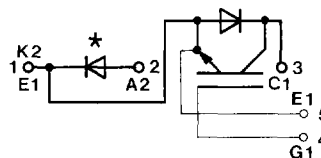

Mechanical Data

| Symbol | Conditions | Values | | | Units |
|----------------|-------------------------|--------|------|--------|------------------|
| | | min. | typ. | max. | |
| M ₁ | to heatsink, SI Units | 3 | — | 6 | Nm |
| | to heatsink, US Units | 27 | — | 53 | lb.in. |
| M ₂ | for terminals, SI Units | 2,5 | — | 5 | Nm |
| | for terminals US Units | 22 | — | 44 | lb.in. |
| a | | — | — | 5x9,81 | m/s ² |
| w | | — | — | 420 | g |

This is an electrostatic discharge sensitive device (ESDS). Please observe the international standard IEC 747-1, Chapter IX.

★The free-wheeling diode has the data of the inverse diode of SKM 200 ...

Dimensions in mm