

SEMIKRON INC

SEMIKRON

V_{RSM} V_{RRM} V	I_{FAV} (sin. 180; $T_{case} = 85^\circ C$) 770 A
800	SKN 650 F 08
1200	SKN 650 F 12
1400	SKN 650 F 14
1600	SKN 650 F 16
1800	SKN 650 F 18

Fast Recovery Rectifier Diodes

SKN 650 F

T.03-23

Symbol	Conditions	SKN 650 F	Units
I_{FAV}	sin. 180; DSC; $T_{case} = 100^\circ C$; $f = 2000$ Hz	650	A
	sin. 180; $R_{thha} = 0,05^\circ C/W$; $f = 2000$ Hz; $T_{amb} = 35^\circ C$; DSC	625	A
I_{FSM}	$T_{vj} = 25^\circ C$ 10 ms	14000	A
	$T_{vj} = 150^\circ C$ 10 ms	13000	A
i^2t	$T_{vj} = 25^\circ C$ 10 ms	980000	A^2s
	$T_{vj} = 150^\circ C$ 10 ms	845000	A^2s
Q_{rr}	$T_{vj} = 150^\circ C$; $I_{FM} = 600$ A; $-\frac{di_F}{dt} = 100 \frac{A}{\mu s}$	200	μC
I_{RM}	$T_{vj} = 150^\circ C$; $I_{FM} = 600$ A; $-\frac{di_F}{dt} = 100 \frac{A}{\mu s}$	160	A
I_R	$T_{vj} = 25^\circ C$; $V_R = V_{RRM}$	4	mA
	$T_{vj} = 150^\circ C$; $V_R = V_{RRM}$	30	mA
V_F	$T_{vj} = 25^\circ C$; $I_{FM} = 1800$ A; max.	2,0	V
$V_{(TO)}$	$T_{vj} = 150^\circ C$	0,95	V
r_T	$T_{vj} = 150^\circ C$	0,6	$m\Omega$
R_{thjc} R_{thch}	} DSC/SSC (Double-sided cooling/ single-sided cooling)	0,04/0,08	$^\circ C/W$
T_{vj}		0,007/0,014	$^\circ C/W$
T_{stg}		-40 ... + 150	$^\circ C$
		-40 ... + 150	$^\circ C$
F	SI units	13,5 ... 16,5	kN
	US units	3000 ... 3500	lbs.
w		200	g
Case		E19	

**Features**

- Small recovered charge
- Soft recovery
- Up to 1800 V reverse voltage
- Hermetic capsule type metal cases with ceramic insulators

Typical Applications

- Inverse diodes for GTO and fast thyristors
- Inverters and choppers
- A. C. motor control
- Uninterruptible power supplies (UPS)

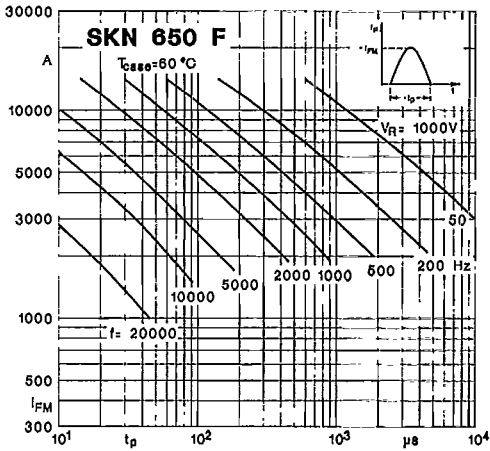

Fig. 1 a Rated sinusoidal peak forward current

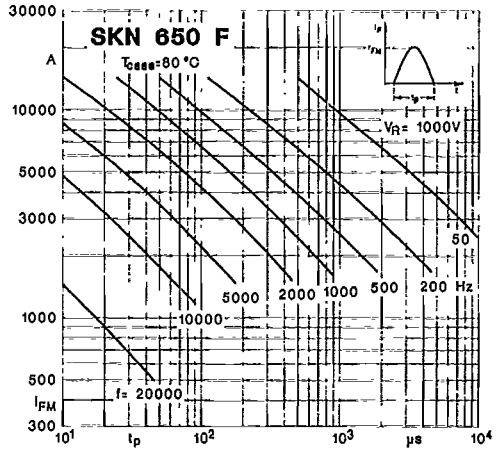

Fig. 1 b Rated sinusoidal peak forward current

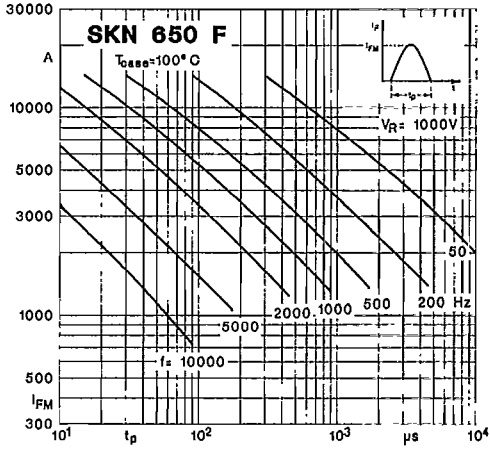

Fig. 1 c Rated sinusoidal peak forward current

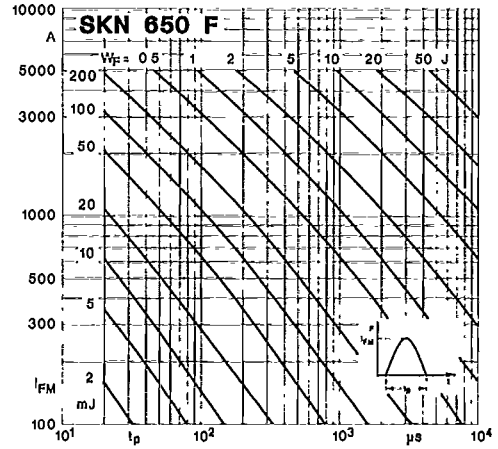

Fig. 2 Forward energy dissipation, sinusoidal

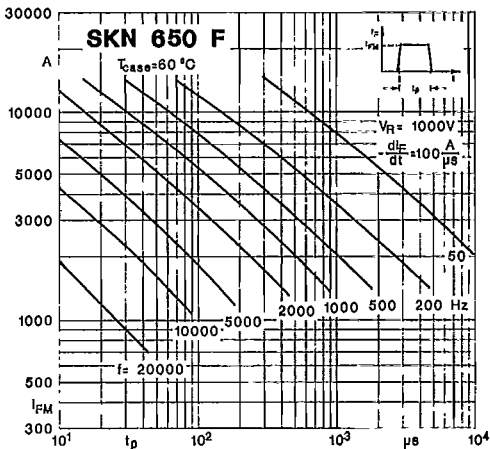

Fig. 3 a Rated rectangular peak forward current

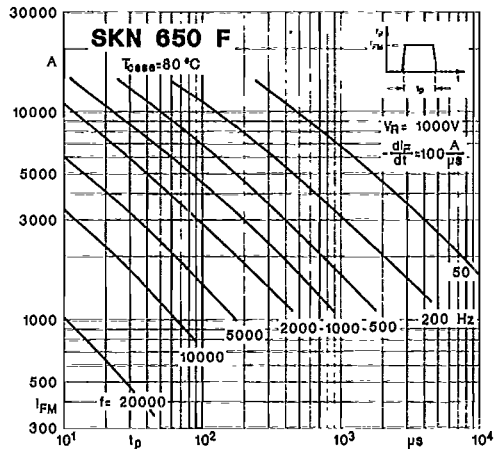

Fig. 3 b Rated rectangular peak forward current

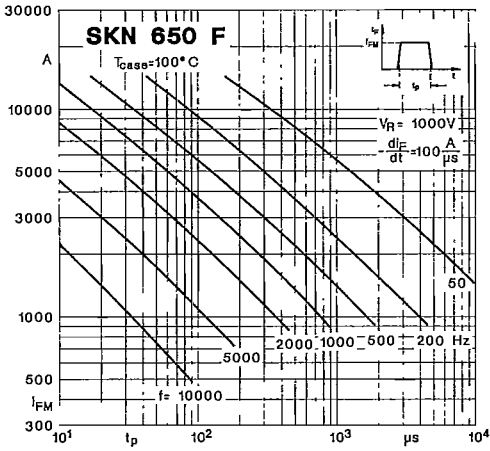

Fig. 3 c Rated rectangular peak forward current

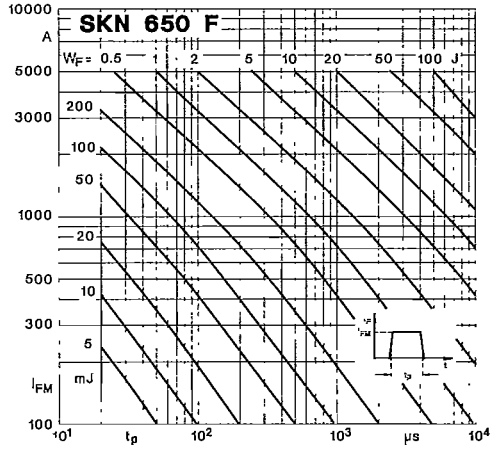

Fig. 4 Forward energy dissipation, rectangular

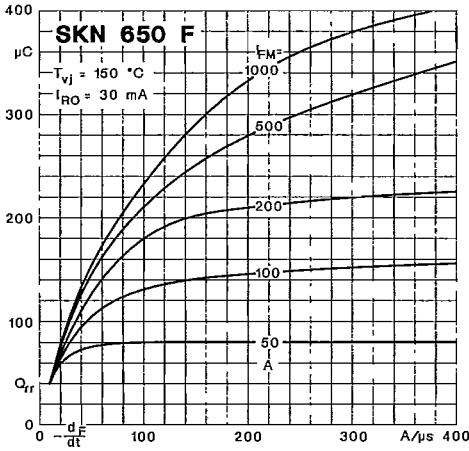

Fig. 5 Recovered charge

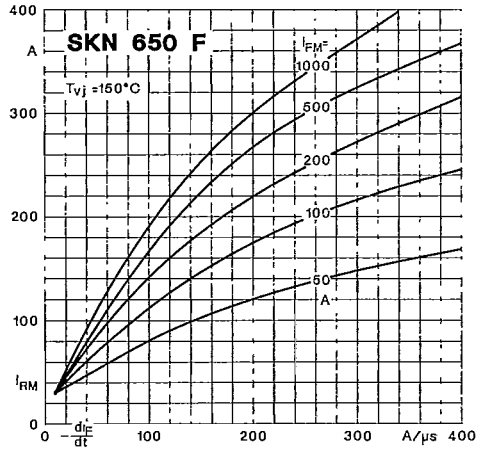

Fig. 6 Peak reverse recovery current

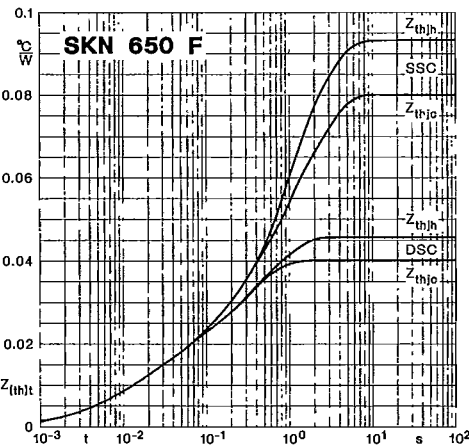

Fig. 7 Transient thermal impedance

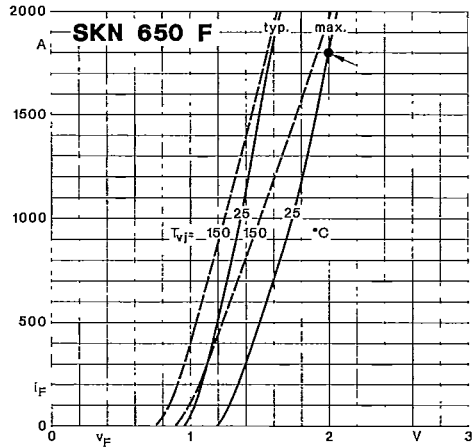

Fig. 8 Forward characteristics

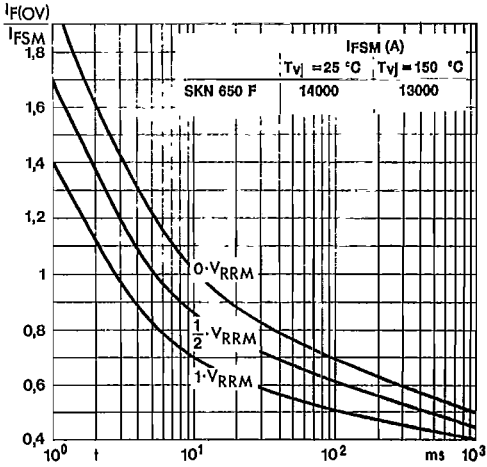
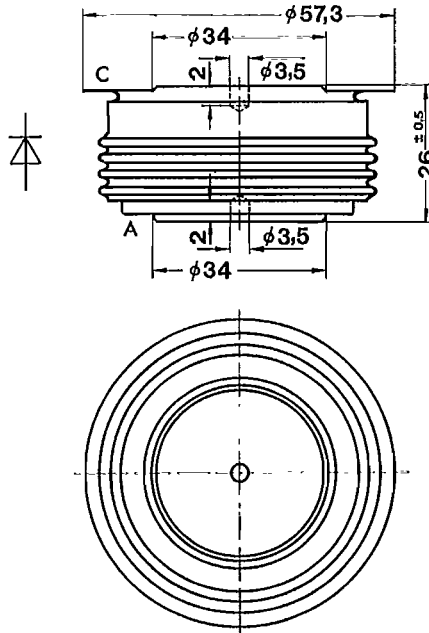

Fig. 9 Rated surge overload current

SKN 650 F

Case E 19

DIN 41 814: 153 C 2
JEDEC: DO-200 AB



Dimensions in mm