

# SKiiP 37NAB065V1

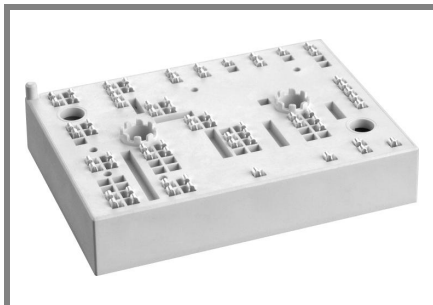

## MiniSKiiP® 3

3-phase bridge rectifier +  
brake chopper + 3-phase  
bridge inverter  
SKiiP 37NAB065V1

### Features

- Ultrafast NPT IGBTs
- Robust and soft freewheeling diodes in CAL technology
- Highly reliable spring contacts for electrical connections
- UL recognised file no. E63532

### Typical Applications

- Inverter up to 18 kVA
- Typical motor power 7,5 kW

### Remarks

- $V_{CEsat}$ ,  $V_F$  = chip level value

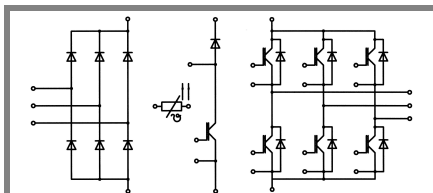

NAB

Absolute Maximum Ratings		$T_s = 25\text{ °C}$ , unless otherwise specified	
Symbol	Conditions	Values	Units
<b>IGBT - Inverter, Chopper</b>			
$V_{CES}$	$T_s = 25\text{ (70) °C}$ $t_p \leq 1\text{ ms}$	600	V
$I_C$		66 (50)	A
$I_{CRM}$		120	A
$V_{GES}$		$\pm 20$	V
$T_j$		- 40 ... + 150	°C
<b>Diode - Inverter, Chopper</b>			
$I_F$	$T_s = 25\text{ (70) °C}$ $t_p \leq 1\text{ ms}$	66 (50)	A
$I_{FRM}$		120	A
$T_j$		- 40 ... + 150	°C
<b>Diode - Rectifier</b>			
$V_{RRM}$	$T_s = 70\text{ °C}$ $t_p = 10\text{ ms, sin } 180\text{ °, } T_j = 25\text{ °C}$ $t_p = 10\text{ ms, sin } 180\text{ °, } T_j = 25\text{ °C}$	800	V
$I_F$		61	A
$I_{FSM}$		700	A
$i^2t$		2400	A <sup>2</sup> s
$T_j$		- 40 ... + 150	°C
$I_{tRMS}$	per power terminal (20 A / spring)	80	A
$T_{stg}$	$T_{op} \leq T_{stg}$	- 40 ... + 125	°C
$V_{isol}$	AC, 1 min.	2500	V

Characteristics		$T_s = 25\text{ °C}$ , unless otherwise specified			
Symbol	Conditions	min.	typ.	max.	Units
<b>IGBT - Inverter, Chopper</b>					
$V_{CEsat}$	$I_{Cnom} = 60\text{ A, } T_j = 25\text{ (125) °C}$		2 (2,2)	2,5 (2,7)	V
$V_{GE(th)}$	$V_{GE} = V_{CE}, I_C = 1\text{ mA}$	3	4	5	V
$V_{CE(TO)}$	$T_j = 25\text{ (125) °C}$		1,2 (1,1)	1,3 (1,2)	V
$r_T$	$T_j = 25\text{ (125) °C}$		13 (18)	20 (25)	mΩ
$C_{ies}$	$V_{CE} = 25\text{ V, } V_{GE} = 0\text{ V, } f = 1\text{ MHz}$		3,3		nF
$C_{oes}$	$V_{CE} = 25\text{ V, } V_{GE} = 0\text{ V, } f = 1\text{ MHz}$		0,7		nF
$C_{res}$	$V_{CE} = 25\text{ V, } V_{GE} = 0\text{ V, } f = 1\text{ MHz}$		0,8		nF
$R_{th(j-s)}$	per IGBT		0,65		K/W
$t_{d(on)}$	under following conditions		35		ns
$t_r$	$V_{CC} = 300\text{ V, } V_{GE} = \pm 15\text{ V}$		35		ns
$t_{d(off)}$	$I_{Cnom} = 60\text{ A, } T_j = 125\text{ °C}$		310		ns
$t_f$	$R_{Gon} = R_{Goff} = 15\text{ Ω}$		20		ns
$E_{on}$	inductive load		1,8		mJ
$E_{off}$			1,4		mJ
<b>Diode - Inverter, Chopper</b>					
$V_F = V_{EC}$	$I_{Fnom} = 60\text{ A, } T_j = 25\text{ (125) °C}$		1,5 (1,5)	1,8 (1,8)	V
$V_{(TO)}$	$T_j = 25\text{ (125) °C}$		1 (0,9)	1,1 (1)	V
$r_T$	$T_j = 25\text{ (125) °C}$		9 (10)	12 (14)	mΩ
$R_{th(j-s)}$	per diode		1		K/W
$I_{RRM}$	under following conditions		80		A
$Q_{rr}$	$I_{Fnom} = 60\text{ A, } V_R = 300\text{ V}$		7,5		μC
$E_{rr}$	$V_{GE} = 0\text{ V, } T_j = 125\text{ °C}$ $di_F/dt = 3500\text{ A/μs}$		1,7		mJ
<b>Diode - Rectifier</b>					
$V_F$	$I_{Fnom} = 35\text{ A, } T_j = 25\text{ °C}$		1,1		V
$V_{(TO)}$	$T_j = 150\text{ °C}$		0,8		V
$r_T$	$T_j = 150\text{ °C}$		11		mΩ
$R_{th(j-s)}$	per diode		0,9		K/W
<b>Temperature Sensor</b>					
$R_{ts}$	3 %, $T_r = 25\text{ (100) °C}$		1000(1670)		Ω
<b>Mechanical Data</b>					
w			95		g
$M_s$	Mounting torque	2		2,5	Nm

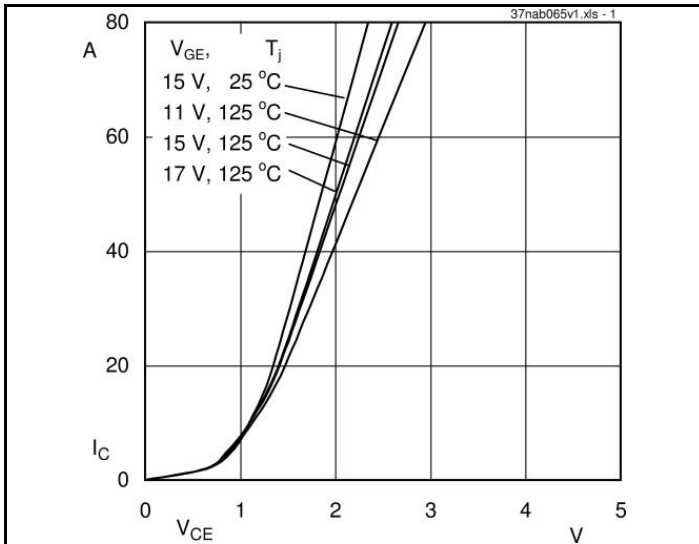

Fig. 1 Typ. output characteristic

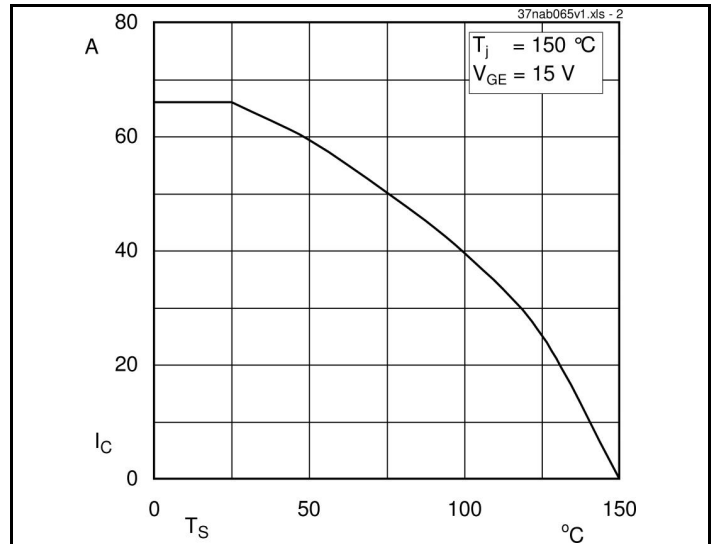

Fig. 2 Typ. rated current vs. temperature

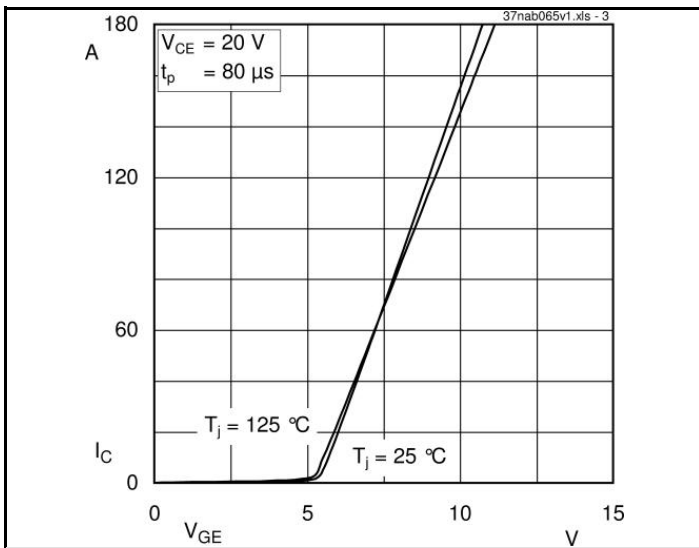

Fig. 3 Typ. transfer characteristic

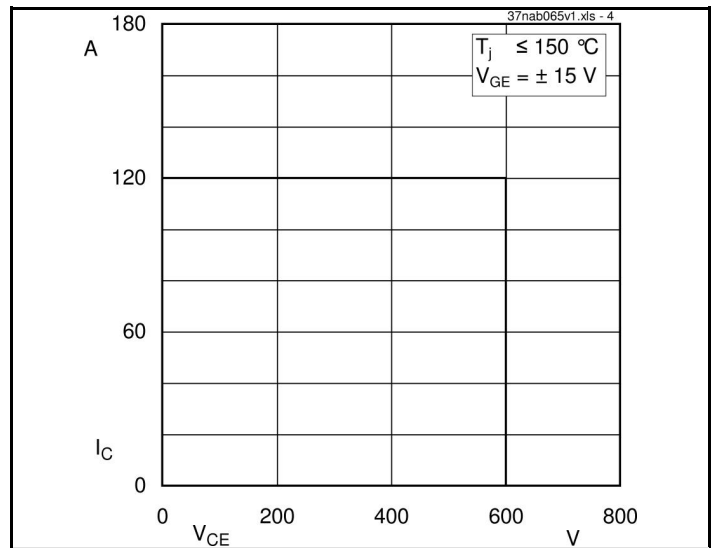

Fig. 4 Reverse bias safe operating area

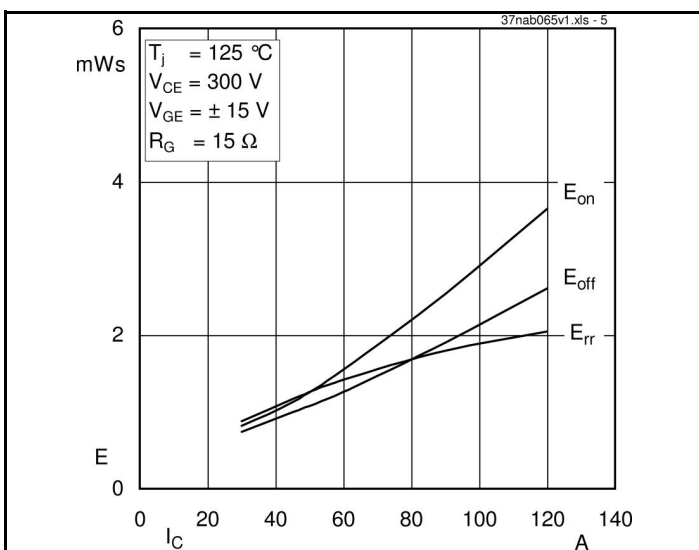

Fig. 5 Typ. Turn-on /-off energy =  $f(I_C)$

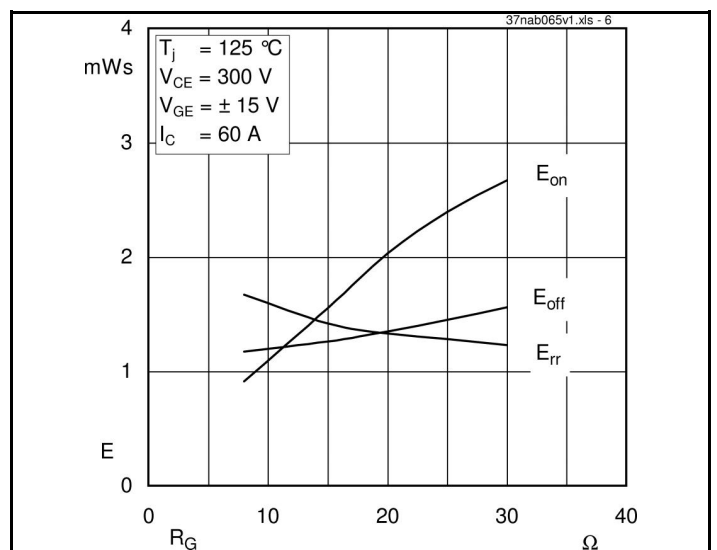
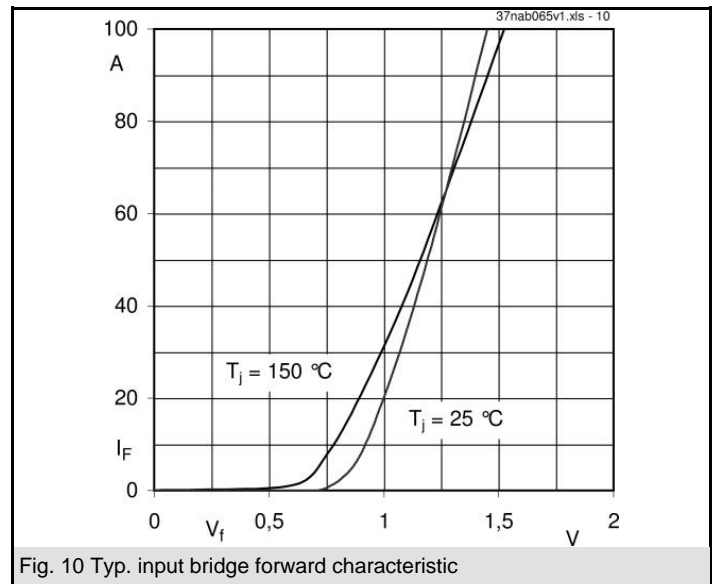
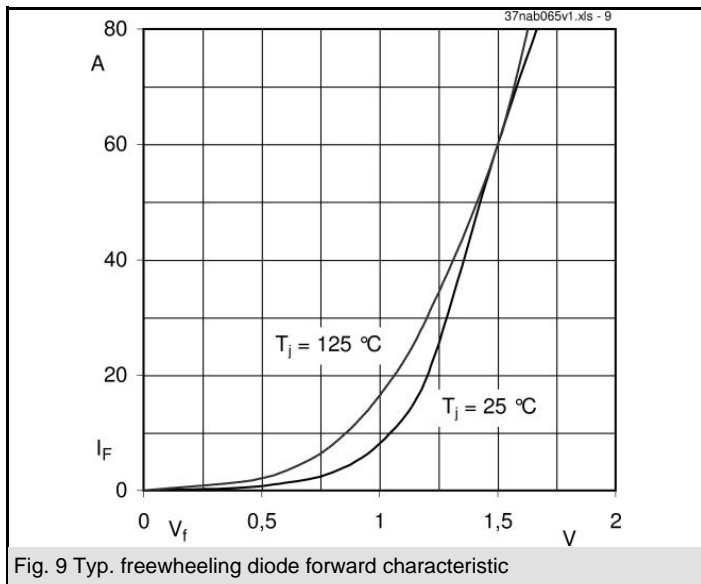
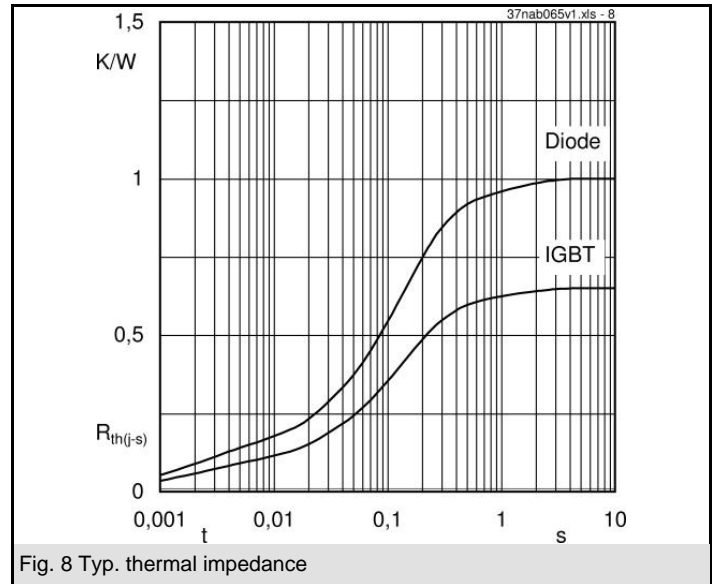
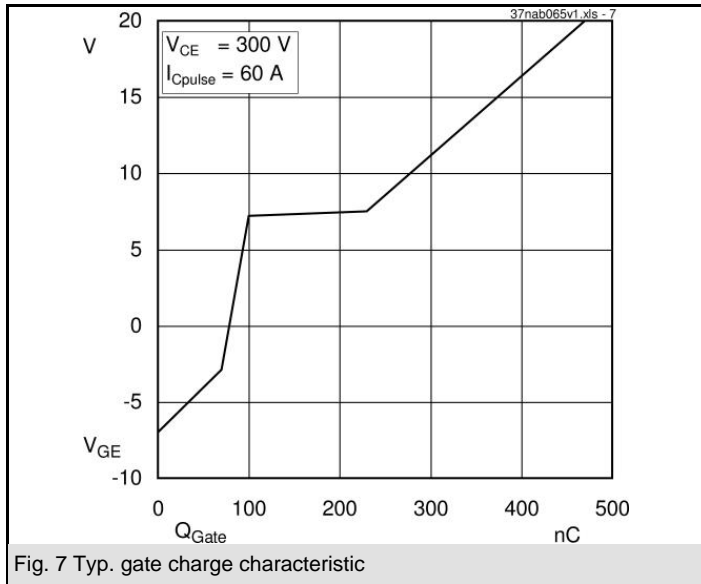
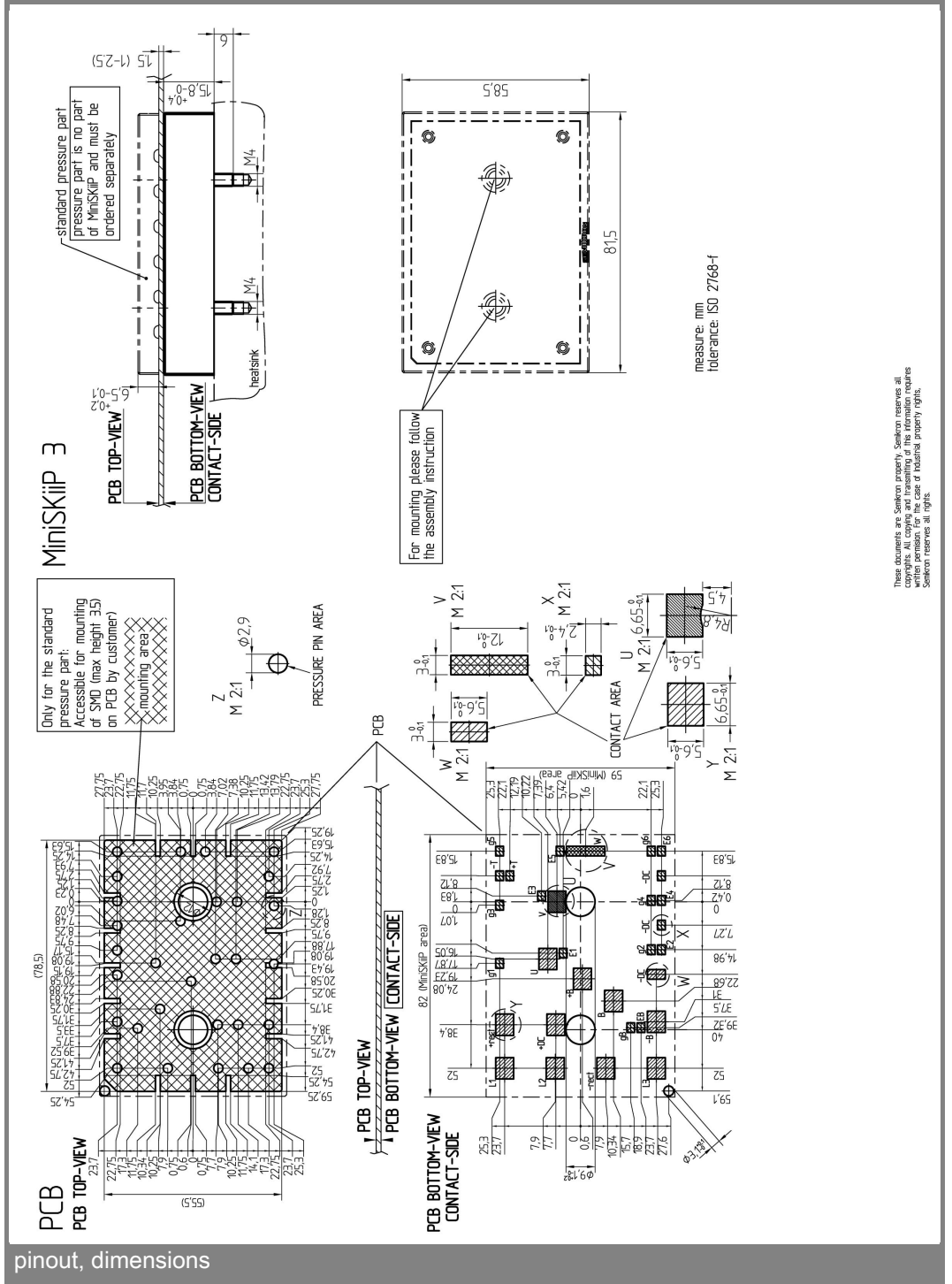
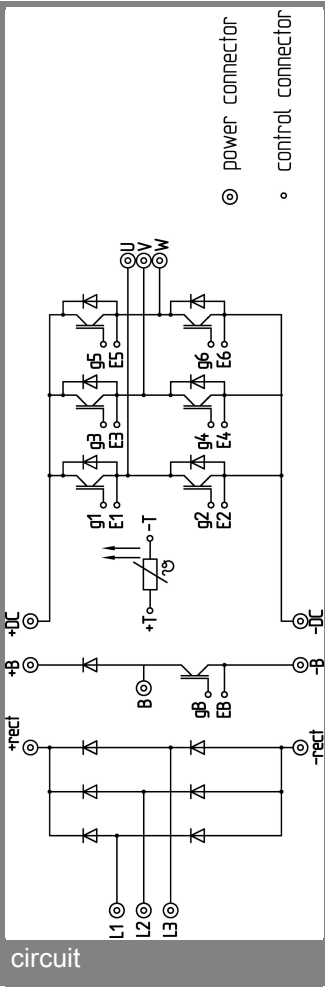

Fig. 6 Typ. Turn-on /-off energy =  $f(R_G)$





This is an electrostatic discharge sensitive device (ESDS), international standard IEC 60747-1, Chapter IX.

This technical information specifies semiconductor devices but promises no characteristics. No warranty or guarantee expressed or implied is made regarding delivery, performance or suitability.