

INVERTER GRADE THYRISTORS

Stud Version

Features

- All diffused design
- Center amplifying gate
- Guaranteed high dv/dt
- Guaranteed high di/dt
- High surge current capability
- Low thermal impedance
- High speed performance

85A

Typical Applications

- Inverters
- Choppers
- Induction heating
- All types of force-commutated converters

Major Ratings and Characteristics

Parameters	ST083S	Units
$I_{T(AV)}$	85	A
@ T_C	85	°C
$I_{T(RMS)}$	135	A
I_{TSM} @ 50Hz	2450	A
@ 60Hz	2560	A
I^2t @ 50Hz	30	KA ² s
@ 60Hz	27	KA ² s
V_{DRM}/V_{RRM}	400 to 1200	V
t_q range (*)	10 to 30	μs
T_J	- 40 to 125	°C

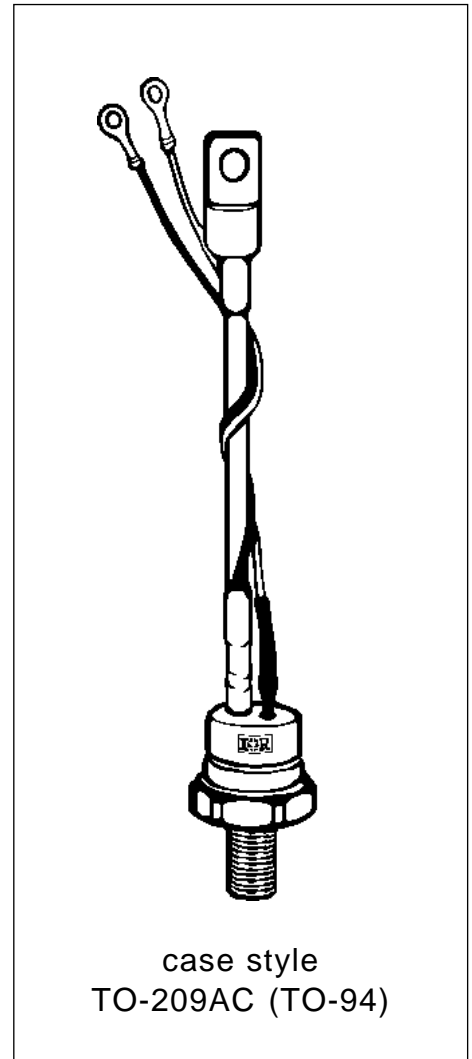

case style
TO-209AC (TO-94)

(*) $t_q = 10$ to $20\mu s$ for 400 to 800V devices
 $t_q = 15$ to $30\mu s$ for 1000 to 1200V devices

ST083S Series

ELECTRICAL SPECIFICATIONS

Voltage Ratings

Type number	Voltage Code	V_{DRM}/V_{RRM} , maximum repetitive peak voltage V	V_{RSM} , maximum non-repetitive peak voltage V	I_{DRM}/I_{RRM} max. @ $T_J = T_J$ max. mA
ST083S	04	400	500	30
	08	800	900	
	10	1000	1100	
	12	1200	1300	

Current Carrying Capability

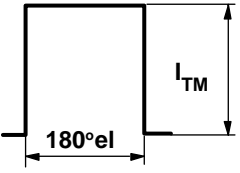
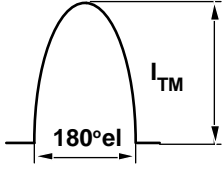
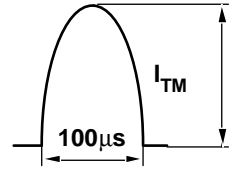
Frequency				Units			
50Hz	210	120	330	270	2540	1930	A
400Hz	200	120	350	210	1190	810	
1000Hz	150	80	320	190	630	400	
2500Hz	70	25	220	85	250	100	
Recovery voltage Vr	50	50	50	50	50	50	V
Voltage before turn-on Vd	V_{DRM}		V_{DRM}		V_{DRM}		
Rise of on-state current di/dt	50	50	-	-	-	-	A/µs
Case temperature	60	85	60	85	60	85	°C
Equivalent values for RC circuit	22Ω / 0.15µF		22Ω / 0.15µF		22Ω / 0.15µF		

On-state Conduction

Parameter	ST083S	Units	Conditions	
$I_{T(AV)}$ Max. average on-state current @ Case temperature	85	A	180° conduction, half sine wave	
	85	°C		
$I_{T(RMS)}$ Max. RMS on-state current	135	A	DC @ 77°C case temperature	
I_{TSM} Max. peak, one half cycle, non-repetitive surge current	2450		t = 10ms	No voltage
	2560		t = 8.3ms	reapplied
	2060		t = 10ms	100% V_{RRM}
	2160	t = 8.3ms	reapplied	
I^2t Maximum I^2t for fusing	30	KA ² s	t = 10ms	No voltage
	27		t = 8.3ms	reapplied
	21		t = 10ms	100% V_{RRM}
	19		t = 8.3ms	reapplied
$I^2\sqrt{t}$ Maximum $I^2\sqrt{t}$ for fusing	300	KA ² √s	t = 0.1 to 10ms, no voltage reapplied	

On-state Conduction

Parameter	ST083S	Units	Conditions
V_{TM} Max. peak on-state voltage	2.15	V	$I_{TM} = 300A, T_J = T_J \text{ max}, t_p = 10\text{ms sine wave pulse}$
$V_{T(TO)1}$ Low level value of threshold voltage	1.46		$(16.7\% \times \pi \times I_{T(AV)} < I < \pi \times I_{T(AV)}), T_J = T_J \text{ max.}$
$V_{T(TO)2}$ High level value of threshold voltage	1.52		$(I > \pi \times I_{T(AV)}), T_J = T_J \text{ max.}$
r_{t1} Low level value of forward slope resistance	2.32	m Ω	$(16.7\% \times \pi \times I_{T(AV)} < I < \pi \times I_{T(AV)}), T_J = T_J \text{ max.}$
r_{t2} High level value of forward slope resistance	2.34		$(I > \pi \times I_{T(AV)}), T_J = T_J \text{ max.}$
I_H Maximum holding current	600	mA	$T_J = 25^\circ\text{C}, I_T > 30A$
I_L Typical latching current	1000		$T_J = 25^\circ\text{C}, V_A = 12V, R_a = 6\Omega, I_G = 1A$

Switching

Parameter	ST083S	Units	Conditions
di/dt Max. non-repetitive rate of rise of turned-on current	1000	A/ μs	$T_J = T_J \text{ max}, V_{DRM} = \text{rated } V_{DRM}$ $I_{TM} = 2 \times \text{di/dt}$
t_d Typical delay time	0.80	μs	$T_J = 25^\circ\text{C}, V_{DM} = \text{rated } V_{DRM}, I_{TM} = 50A \text{ DC}, t_p = 1\mu\text{s}$ Resistive load, Gate pulse: 10V, 5 Ω source
t_q Max. turn-off time (*)	Min 10 Max 30		$T_J = T_J \text{ max}, I_{TM} = 100A, \text{commutating di/dt} = 10A/\mu\text{s}$ $V_R = 50V, t_p = 200\mu\text{s}, \text{dv/dt: see table in device code}$

(*) $t_q = 10$ to $20\mu\text{s}$ for 400 to 800V devices; $t_q = 15$ to $30\mu\text{s}$ for 1000 to 1200V devices.

Blocking

Parameter	ST083S	Units	Conditions
dv/dt Maximum critical rate of rise of off-state voltage	500	V/ μs	$T_J = T_J \text{ max.}, \text{linear to } 80\% V_{DRM}, \text{higher value available on request}$
I_{RRM} I_{DRM} Max. peak reverse and off-state leakage current	30	mA	$T_J = T_J \text{ max}, \text{rated } V_{DRM}/V_{RRM} \text{ applied}$

Triggering

Parameter	ST083S	Units	Conditions
P_{GM} Maximum peak gate power	40	W	$T_J = T_J \text{ max}, f = 50\text{Hz}, d\% = 50$
$P_{G(AV)}$ Maximum average gate power	5		
I_{GM} Max. peak positive gate current	5	A	$T_J = T_J \text{ max}, t_p \leq 5\text{ms}$
$+V_{GM}$ Maximum peak positive gate voltage	20	V	$T_J = T_J \text{ max}, t_p \leq 5\text{ms}$
$-V_{GM}$ Maximum peak negative gate voltage	5		
I_{GT} Max. DC gate current required to trigger	200	mA	$T_J = 25^\circ\text{C}, V_A = 12V, R_a = 6\Omega$
V_{GT} Max. DC gate voltage required to trigger	3	V	
I_{GD} Max. DC gate current not to trigger	20	mA	$T_J = T_J \text{ max}, \text{rated } V_{DRM} \text{ applied}$
V_{GD} Max. DC gate voltage not to trigger	0.25	V	

ST083S Series

Thermal and Mechanical Specifications

Parameter	ST083S	Units	Conditions
T _J Max. junction operating temperature range	-40 to 125	°C	
T _{stg} Max. storage temperature range	-40 to 150		
R _{thJC} Max. thermal resistance, junction to case	0.195	K/W	DC operation
R _{thCS} Max. thermal resistance, case to heatsink	0.08		Mounting surface, smooth, flat and greased
T Mounting torque, ± 10%	15.5 (137)	Nm (lbf-in)	Non lubricated threads
	14 (120)	Nm (lbf-in)	Lubricated threads
wt Approximate weight	130	g	
Case style	TO-209AC (TO-94)		See Outline Table

ΔR_{thJC} Conduction

(The following table shows the increment of thermal resistance R_{thJC} when devices operate at different conduction angles than DC)

Conduction angle	Sinusoidal conduction	Rectangular conduction	Units	Conditions
180°	0.034	0.025	K/W	T _J = T _J max.
120°	0.041	0.042		
90°	0.052	0.056		
60°	0.076	0.079		
30°	0.126	0.127		

Ordering Information Table

Device Code

ST	08	3	S	12	P	F	K	0	
①	②	③	④	⑤	⑥	⑦	⑧	⑨	⑩

- 1** - Thyristor
- 2** - Essential part number
- 3** - 3 = Fast turn off
- 4** - S = Compression bonding Stud
- 5** - Voltage code: Code x 100 = V_{RRM} (See Voltage Ratings Table)
- 6** - P = Stud Base 1/2" 20UNF
- 7** - Reapplied dv/dt code (for t_q Test Condition)
- 8** - t_q code
- 9** - 0 = Eyelet terminals (Gate and Aux. Cathode Leads)
 1 = Fast-on terminals (Gate and Aux. Cathode Leads)
 2 = Flag terminals (For Cathode and Gate Terminals)
- 10** - Critical dv/dt:
 None = 500V/μsec (Standard value)
 L = 1000V/μsec (Special selection)

		20	50	100	200	400
t _q (μs)	10	CN	DN	EN	FN *	HN
	12	CM	DM	EM	FM *	HM
	15	CL	DL	EL	FL	HL
	18	CP	DP	EP	FP *	HP
	20	CK	DK	EK	FK *	HK
t _q (μs)	15	CL	--	--	--	--
	18	CP	DP	EP	FP *	--
	20	CK	DK	EK	FK *	HK
	25	CJ	DJ	EJ	FJ	HJ
	30	--	DH	EH	FH	HH

*Standard part number.
All other types available only on request.

Outline Table

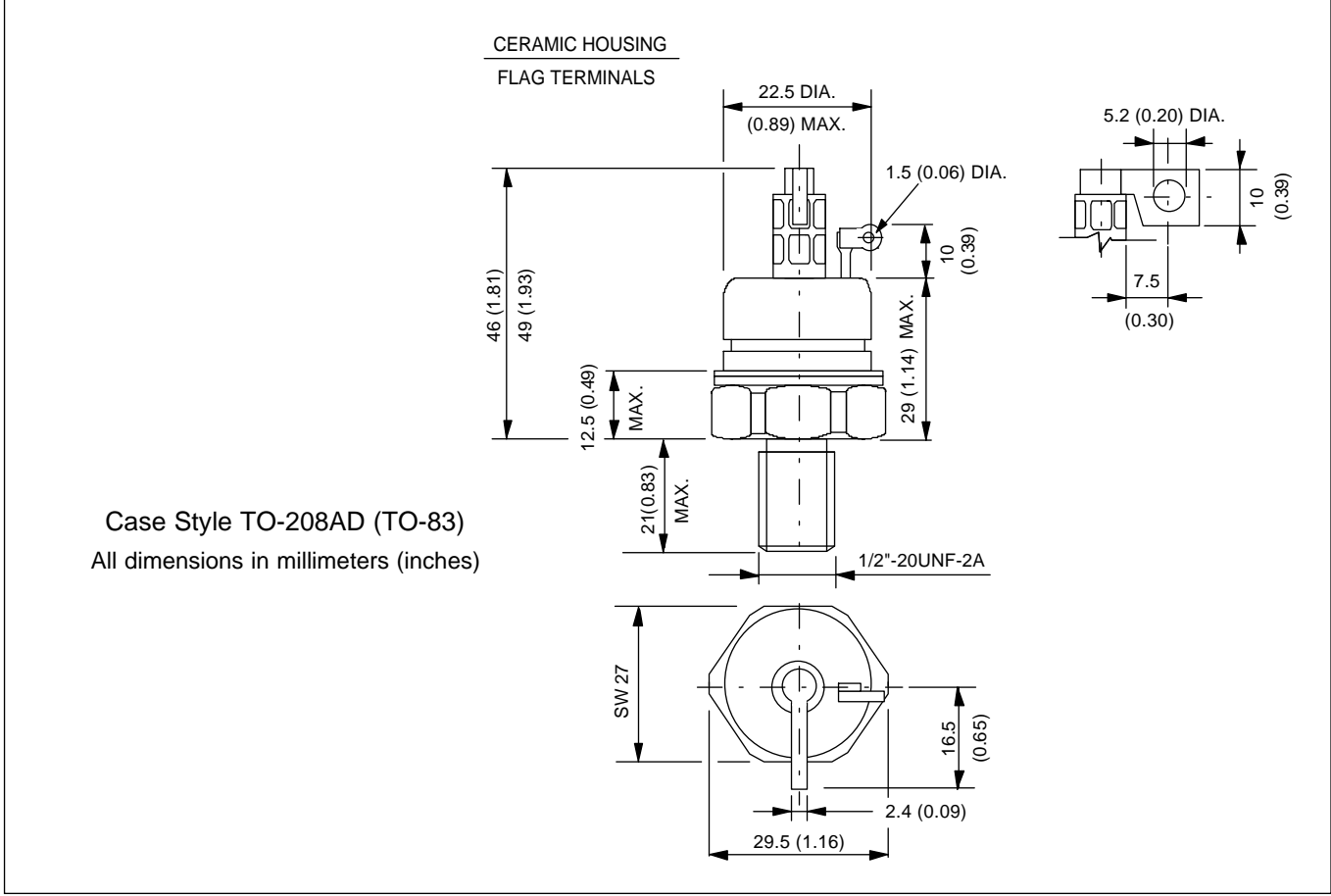
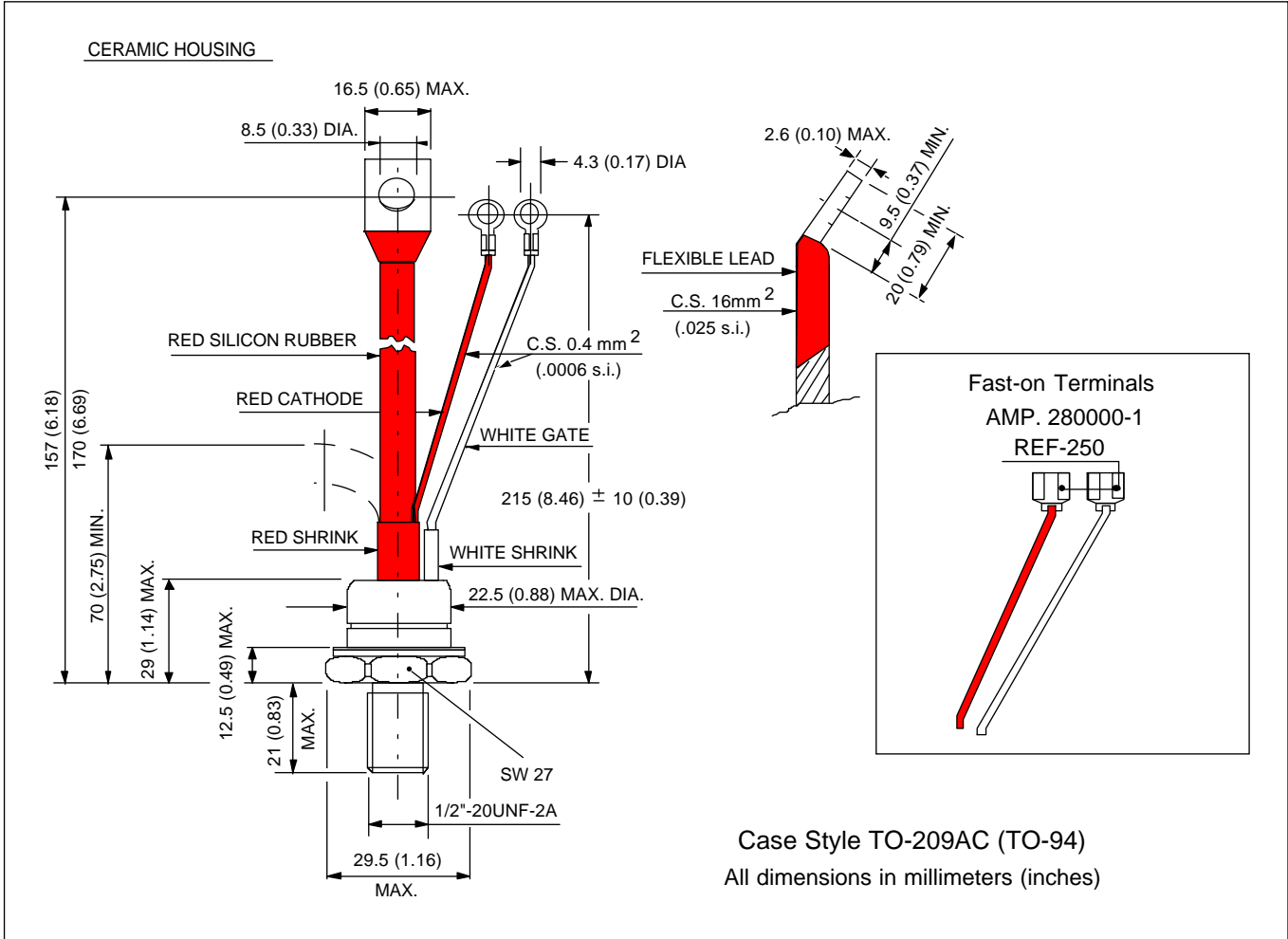

ST083S Series

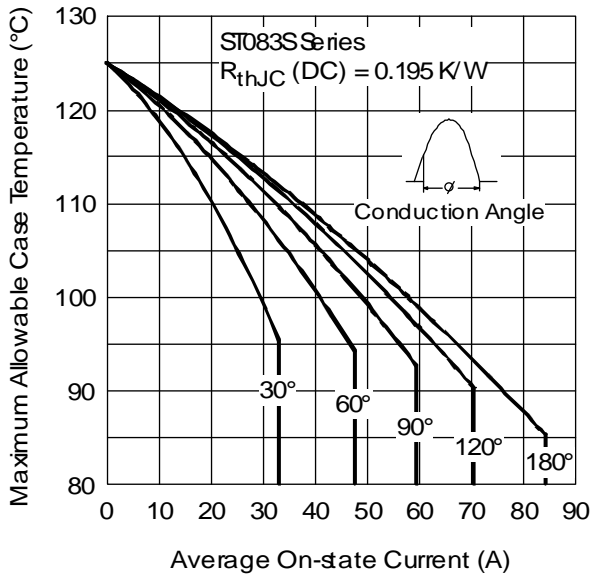

Fig. 1 - Current Ratings Characteristics

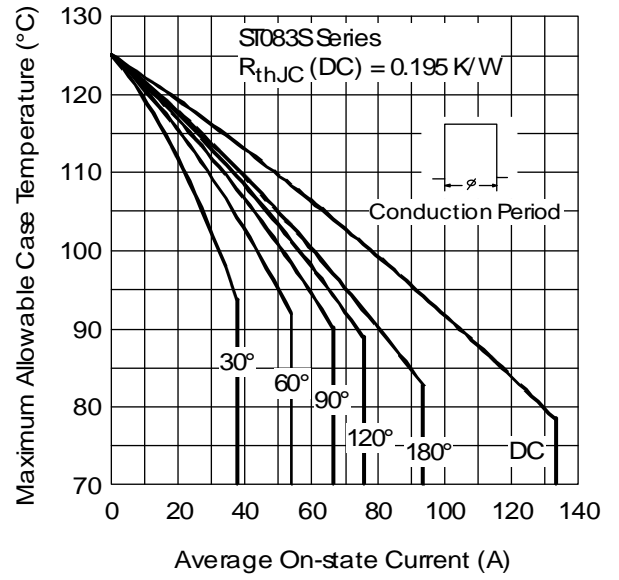

Fig. 2 - Current Ratings Characteristics

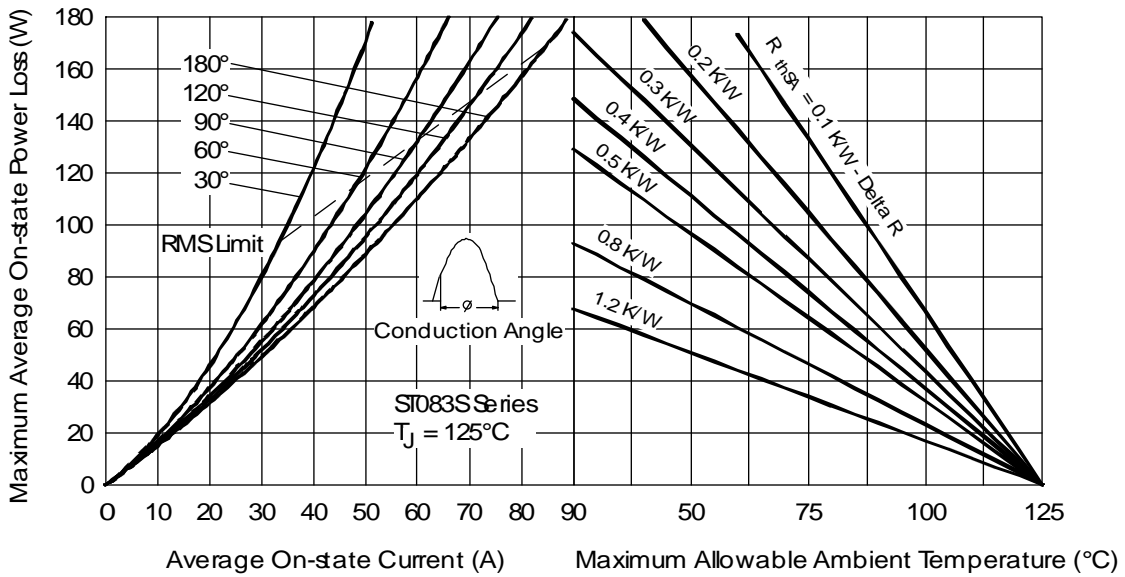

Fig. 3 - On-state Power Loss Characteristics

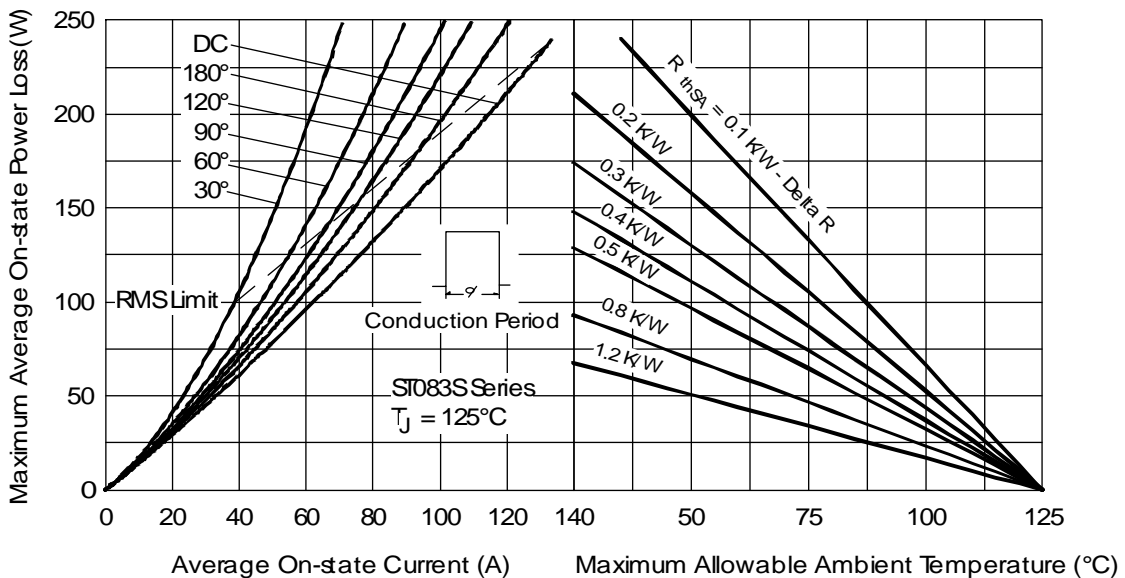

Fig. 4 - On-state Power Loss Characteristics

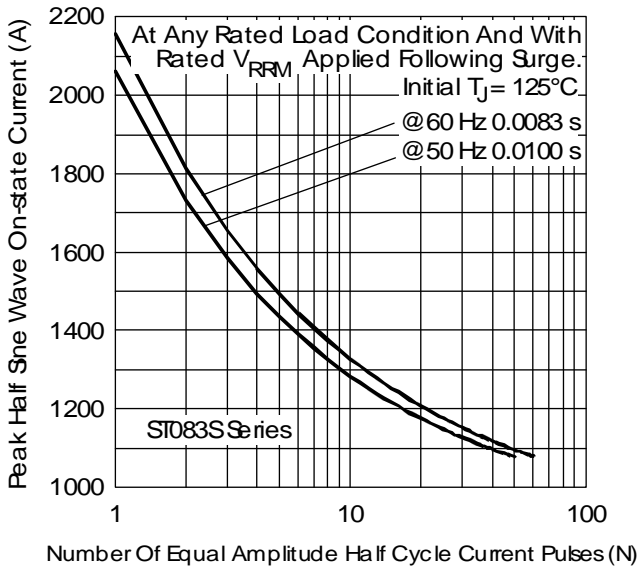

Fig. 5 - Maximum Non-repetitive Surge Current

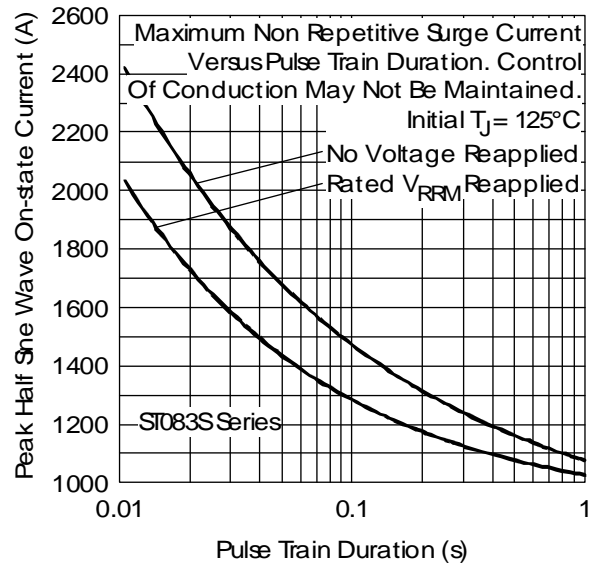

Fig. 6 - Maximum Non-repetitive Surge Current

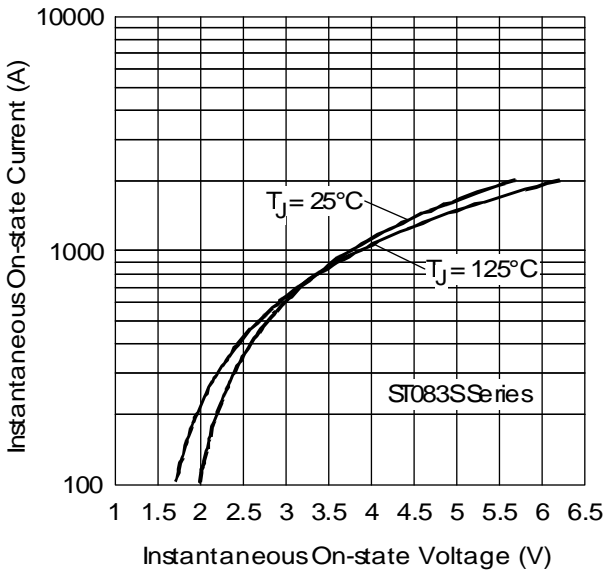

Fig. 7 - On-state Voltage Drop Characteristics

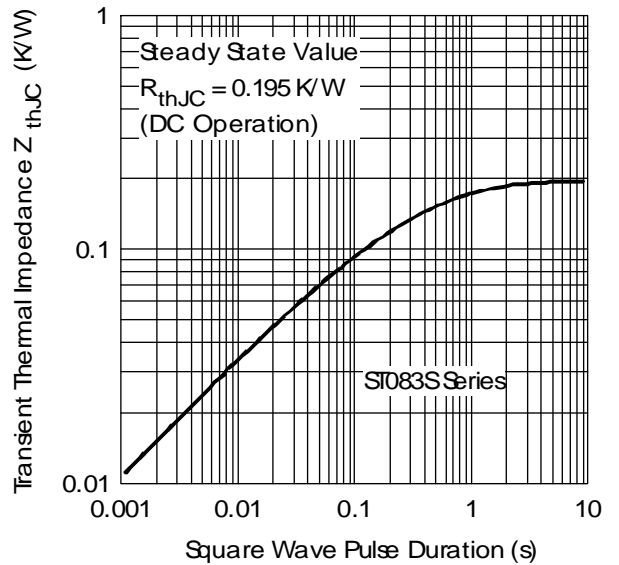

Fig. 8 - Thermal Impedance Z_{thJC} Characteristic

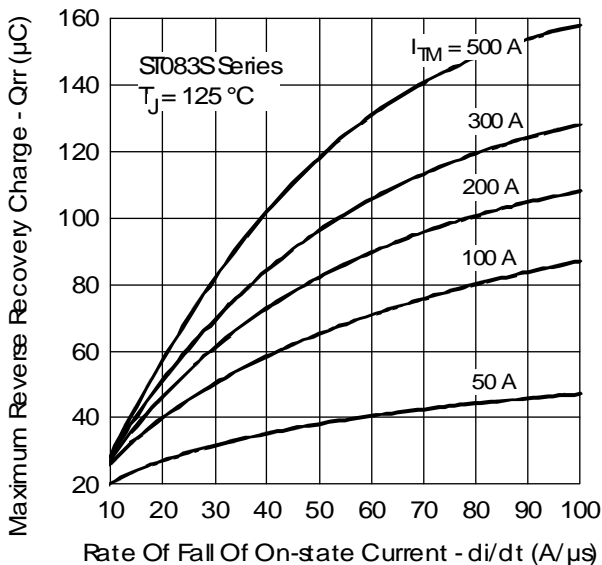

Fig. 9 - Reverse Recovered Charge Characteristics

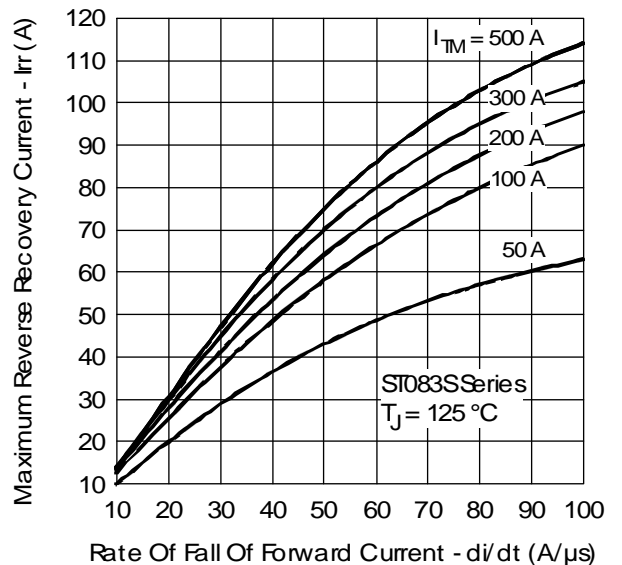

Fig. 10 - Reverse Recovery Current Characteristics

ST083S Series

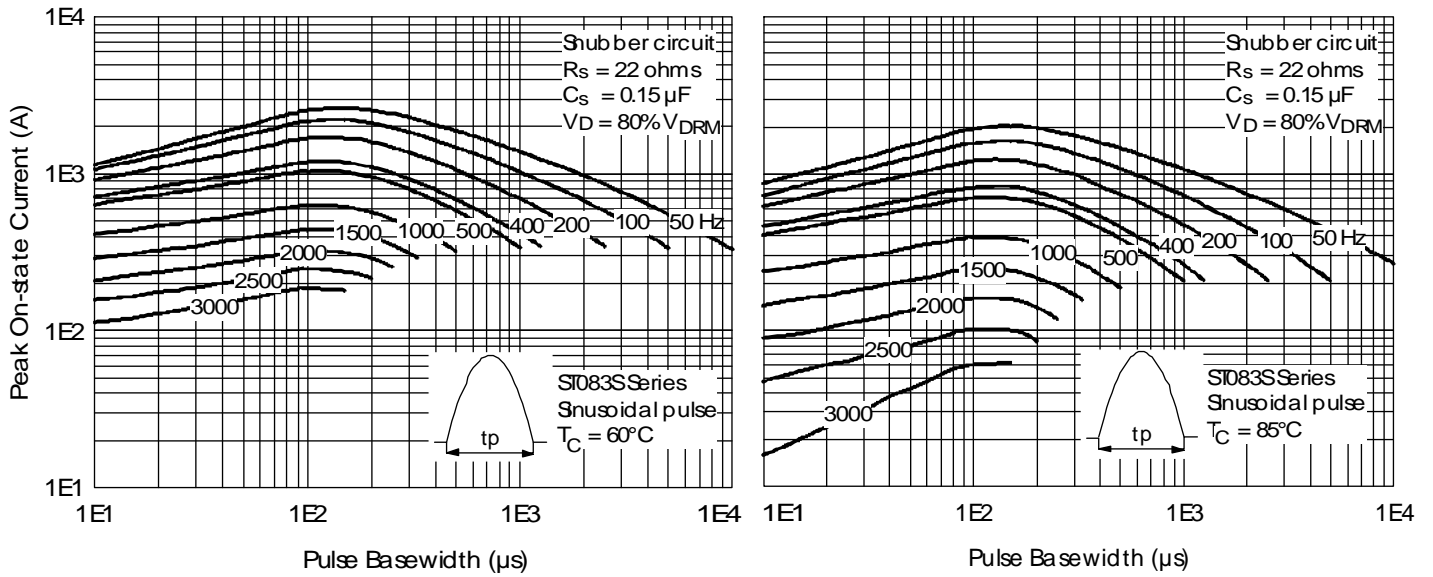

Fig. 11 - Frequency Characteristics

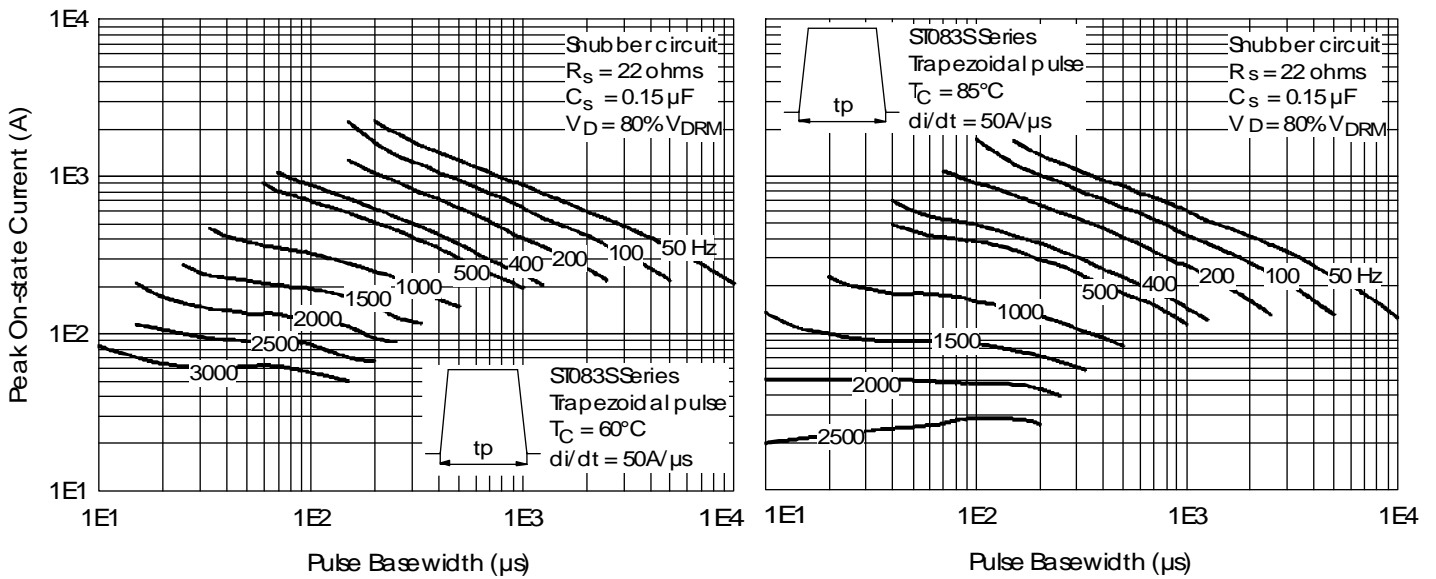

Fig. 12 - Frequency Characteristics

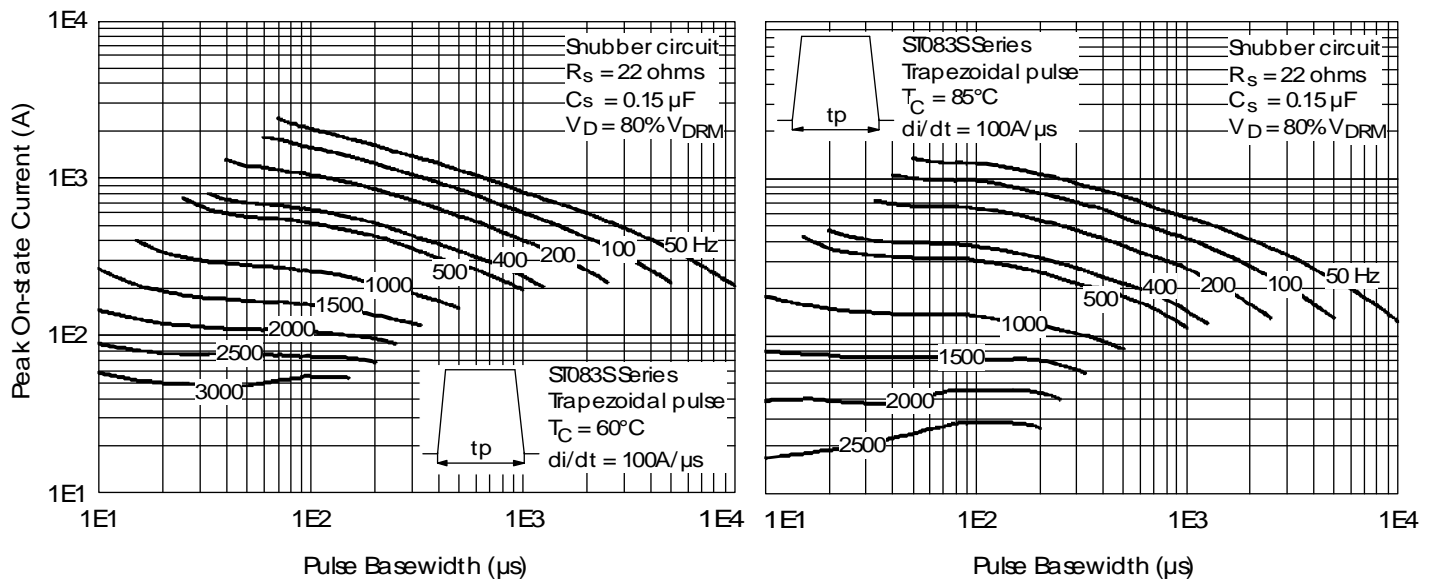

Fig. 13 - Frequency Characteristics

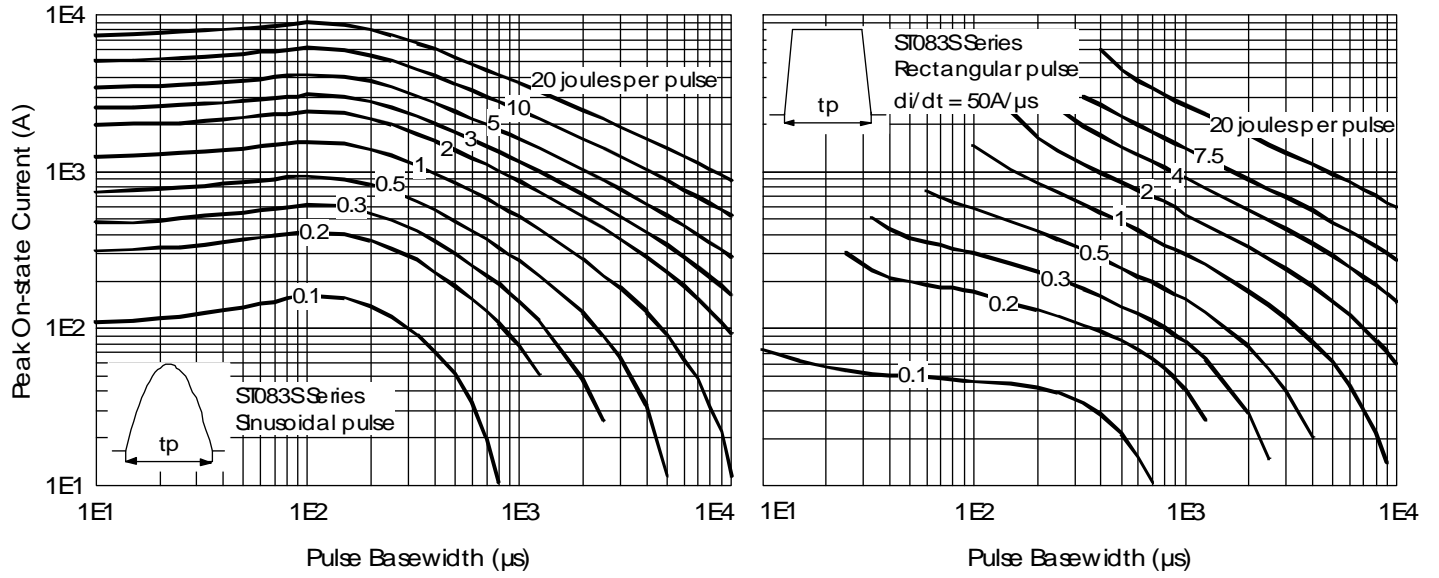

Fig. 14 - Maximum On-state Energy Power Loss Characteristics

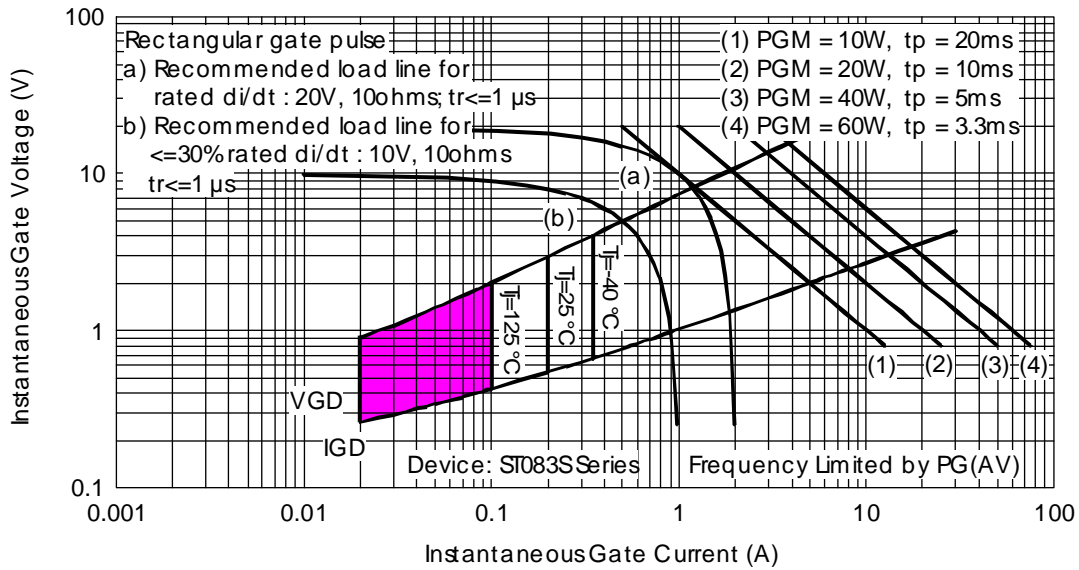

Fig. 15 - Gate Characteristics