



TAN250A

250 Watts, 50 Volts, Pulsed
Avionics 960 - 1215 MHz

GENERAL DESCRIPTION

The TAN250A is a high powered COMMON BASE bipolar transistor. It is designed for pulsed systems in the frequency band 960-1215 MHz. The device has gold thin-film metallization and diffused ballasting for proven highest MTTF. The transistor includes input and output prematch for broadband capability. Low thermal resistance package reduces junction temperature, extends life.

CASE OUTLINE 55AW, Style 1

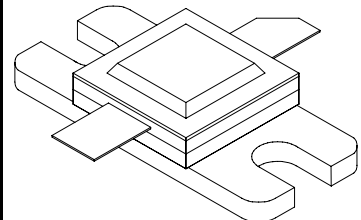

ABSOLUTE MAXIMUM RATINGS

Maximum Power Dissipation

Device Dissipation @25°C 575 W

Maximum Voltage and Current

Collector to Base Voltage (BV_{ces}) 60 V

Emitter to Base Voltage (BV_{ebo}) 4.0 V

Collector Current (I_c) 30 A

Maximum Temperatures

Storage Temperature -65 to +200 °C

Operating Junction Temperature +200 °C

ELECTRICAL CHARACTERISTICS @ 25°C

SYMBOL	CHARACTERISTICS	TEST CONDITIONS	MIN	TYP	MAX	UNITS
P_{out}	Power Out	F = 960-1215 MHz	250			W
P_{in}	Power Input	$V_{cc} = 50$ Volts			60	W
P_g	Power Gain	PW = 20 μ sec	6.2	7.0		dB
η_c	Collector Efficiency	DF = 5%		40		%
VSWR	Load Mismatch Tolerance	F = 1090 MHz			5:1	

FUNCTIONAL CHARACTERISTICS @ 25°C

BV_{ebo}	Emitter to Base Breakdown	$I_e = 20$ mA	4.0			V
BV_{ces}	Collector to Emitter Breakdown	$I_c = 25$ mA	60			V
h_{FE}	DC - Current Gain	$V_{ce} = 5V, I_c = 1$ A	10			
θ_{jc}^2	Thermal Resistance				.3	°C/W

NOTE 1: At rated output power and pulse conditions
2. At rated pulse conditions

Revision A, August 2010

TAN250A

BROADBAND POWER OUTPUT vs FREQUENCY

Vcc = 50 V, Pin = 60 W

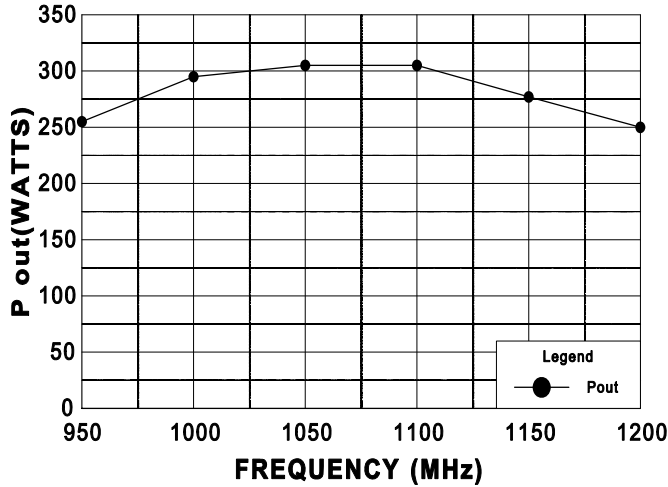

THERMAL RESISTANCE vs PULSE WIDTH

Vcc = 50 V, Pin = 60 W, Duty 5%

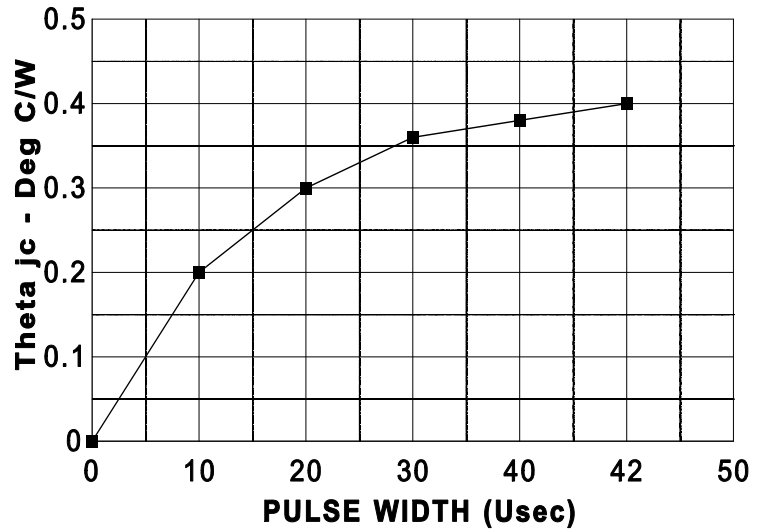

SERIES INPUT IMPEDANCE vs FREQUENCY

Vcc = 50 V, Po = 250 W

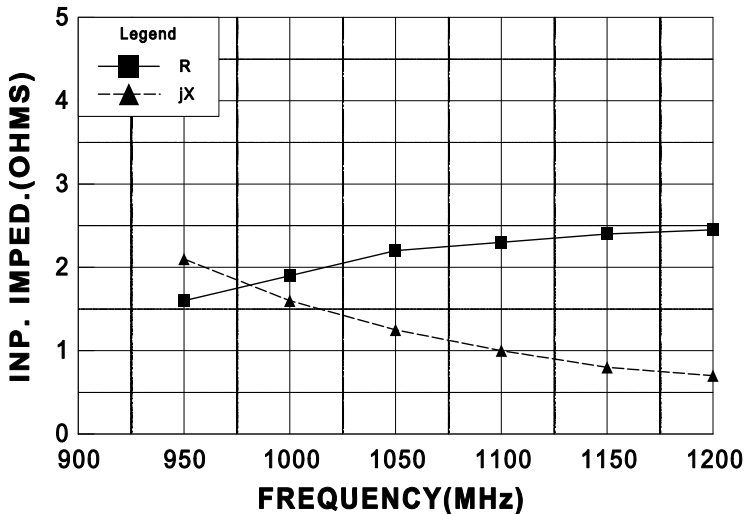

SERIES LOAD IMPEDANCE vs FREQUENCY

Vcc = 50 V, Po = 250 W

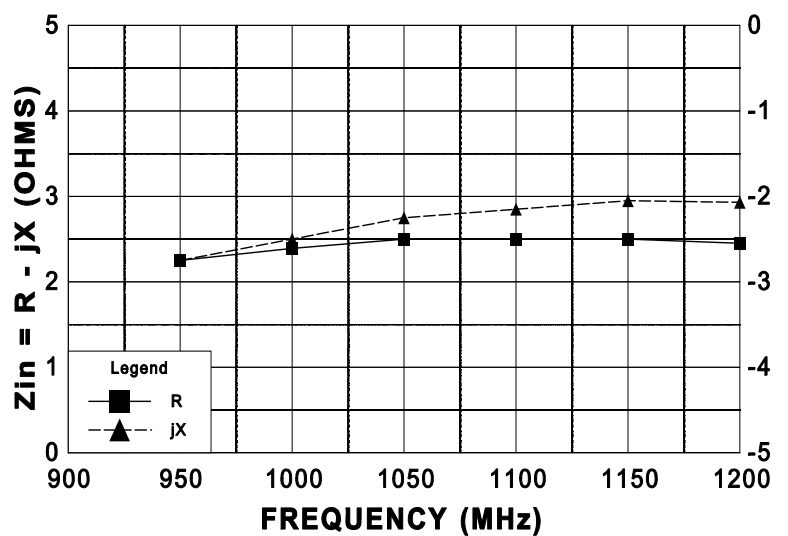

June 1996

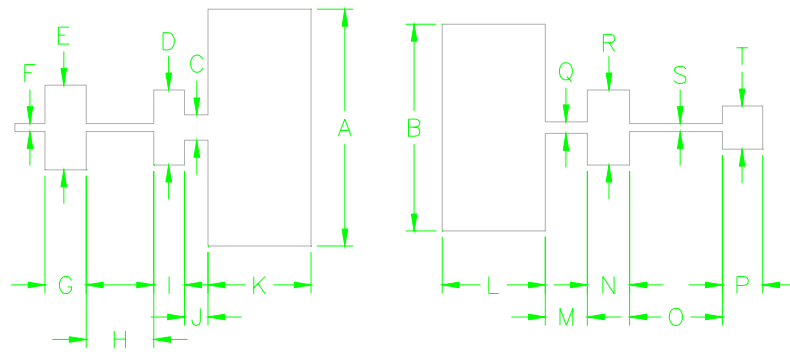

DIM	INCHES
A	1.260
B	1.100
C	.135
D	.400
E	.450
F	.042
G	.220
H	.360
I	.160
J	.125
K	.550
L	.550
M	.225
N	.250
O	.495
P	.215
Q	.062
R	.400
S	.042
T	.230

960-1215 MHz BROADBAND TEST AMPLIFIER

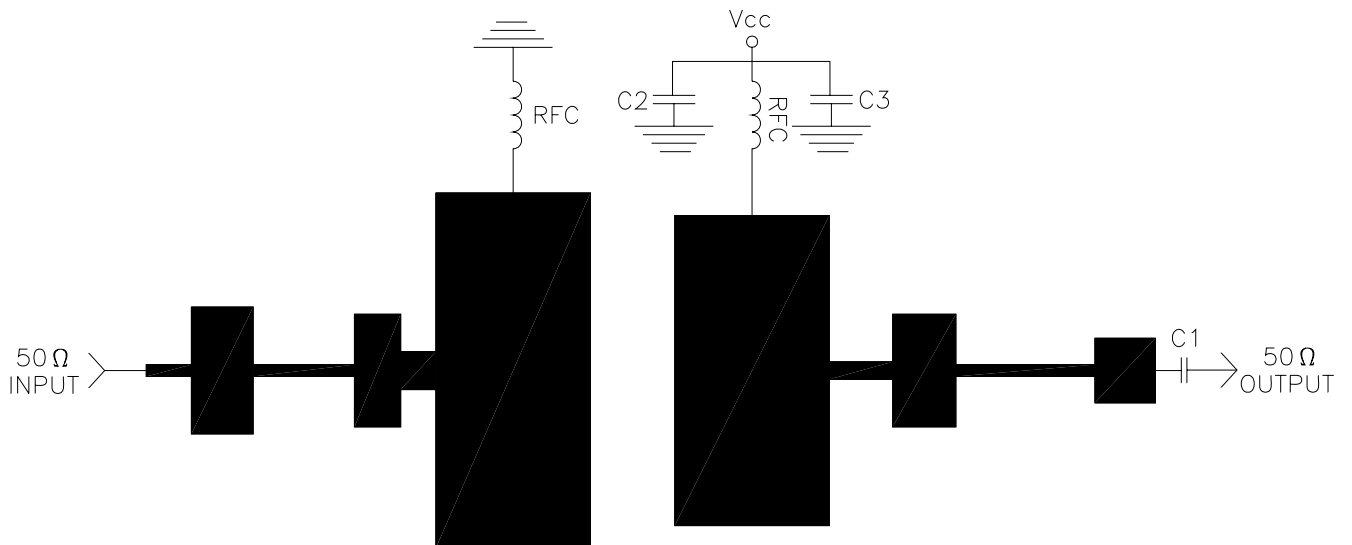

PCB-.015" TFE, 2 oz, CU. type "GT", $\epsilon_r = 2.55$
 C1, C2 - 82pf Chip
 C3-250 MFD

DWG NO.

TAN 250A

REVISIONS

ZONE	REV	DESCRIPTION	DATE	APPROVED
------	-----	-------------	------	----------

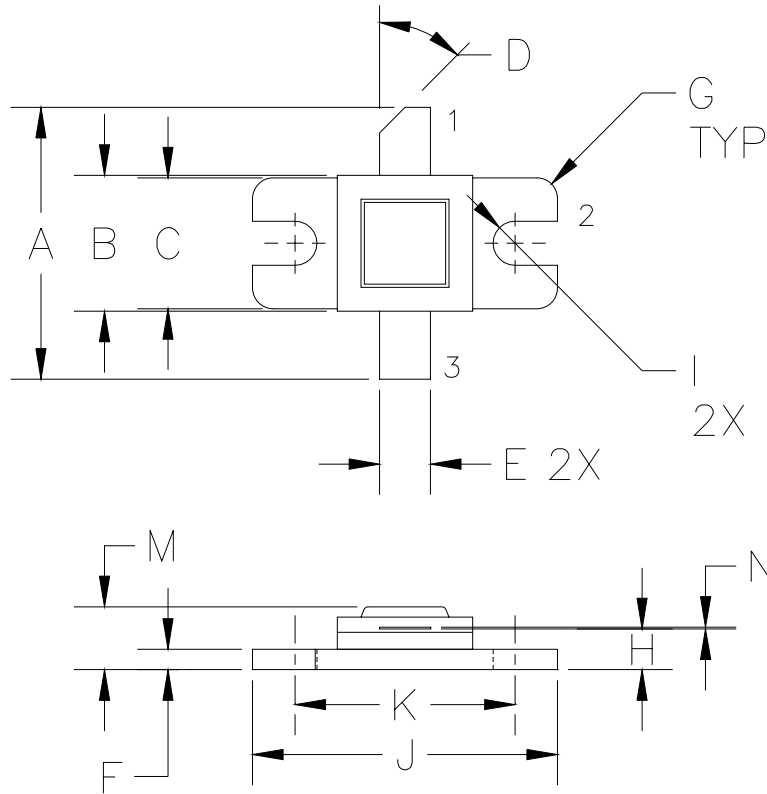

DIM	MILLIMETER	±TOL	INCHES	±TOL
A	20.32	.76	.800	.050
B	10.16	.13	.400	.005
C	9.78	.13	.385	.005
D	45°	5°	45°	5°
E	3.81	.13	.150	.005
F	1.52	.13	.060	.005
G	1.52R	.13	.060R	.005
H	3.05	.13	.120	.005
I	3.30 DIA	.13	.130 DIA	.005
J	22.86	.13	.900	.005
K	16.51	.13	.650	.005
M	4.70	REF	.185	REF
N	0.13	.02	.005	.001

STYLE 1:
 PIN1 = COLLECTOR
 2 = BASE
 3 = EMITTER

STYLE 2:
 PIN1 = COLLECTOR
 2 = EMITTER
 3 = BASE

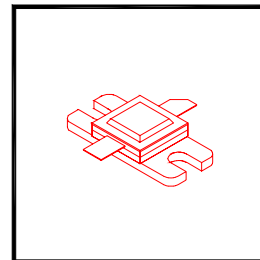

CAGE	DWG NO.	REV
0PJR2	55AW	A
SCALE	SHEET	
2/1		