

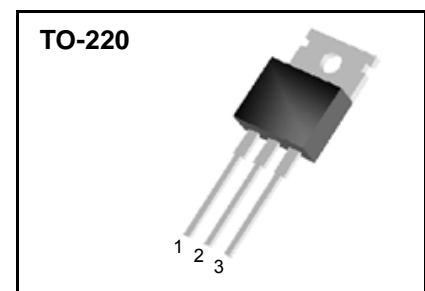
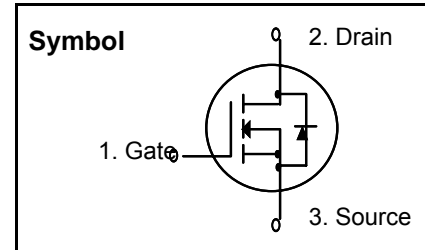
## N-Channel MOSFET

### Features

- $R_{DS(on)}$  (Max 0.18  $\Omega$ )@ $V_{GS}=10V$
- Gate Charge (Typical 45nC)
- Improved dv/dt Capability, High Ruggedness
- 100% Avalanche Tested
- Maximum Junction Temperature Range (150°C)

### General Description

This Power MOSFET is produced using Wisdom's advanced planar stripe, DMOS technology. This latest technology has been especially designed to minimize on-state resistance, have a high rugged avalanche characteristics. These devices are well suited for high efficiency switching DC/DC converters, switch mode power supply, DC-AC converters for uninterrupted power supply, motor control.



### Absolute Maximum Ratings

Symbol	Parameter	Value	Units
$V_{DSS}$	Drain to Source Voltage	200	V
$I_D$	Continuous Drain Current(@ $T_C = 25^\circ C$ )	18	A
	Continuous Drain Current(@ $T_C = 100^\circ C$ )	11.4	A
$I_{DM}$	Drain Current Pulsed (Note 1)	72	A
$V_{GS}$	Gate to Source Voltage	$\pm 25$	V
$E_{AS}$	Single Pulsed Avalanche Energy (Note 2)	250	mJ
$E_{AR}$	Repetitive Avalanche Energy (Note 1)	13.9	mJ
dv/dt	Peak Diode Recovery dv/dt (Note 3)	5.5	V/ns
$P_D$	Total Power Dissipation(@ $T_C = 25^\circ C$ )	139	W
	Derating Factor above 25 °C	1.11	W/°C
$T_{STG}, T_J$	Operating Junction Temperature & Storage Temperature	- 55 ~ 150	°C
$T_L$	Maximum Lead Temperature for soldering purpose, 1/8 from Case for 5 seconds.	300	°C

### Thermal Characteristics

Symbol	Parameter	Value			Units
		Min.	Typ.	Max.	
$R_{\theta JC}$	Thermal Resistance, Junction-to-Case	-	-	0.90	°C/W
$R_{\theta CS}$	Thermal Resistance, Case to Sink	-	0.5	-	°C/W
$R_{\theta JA}$	Thermal Resistance, Junction-to-Ambient	-	-	62.5	°C/W

## Electrical Characteristics

$T_C = 25^\circ\text{C}$  unless otherwise noted

Symbol	Parameter	Test Conditions	Min	Typ	Max	Units
<b>Off Characteristics</b>						
$BV_{DSS}$	Drain-Source Breakdown Voltage	$V_{GS} = 0\text{ V}, I_D = 250\ \mu\text{A}$	200	--	--	V
$\frac{\Delta BV_{DSS}}{\Delta T_J}$	Breakdown Voltage Temperature Coefficient	$I_D = 250\ \mu\text{A}$ , Referenced to $25^\circ\text{C}$	--	0.20	--	$\text{V}/^\circ\text{C}$
$I_{DSS}$	Zero Gate Voltage Drain Current	$V_{DS} = 200\text{ V}, V_{GS} = 0\text{ V}$	--	--	1	$\mu\text{A}$
		$V_{DS} = 160\text{ V}, T_C = 125^\circ\text{C}$	--	--	10	$\mu\text{A}$
$I_{GSSF}$	Gate-Body Leakage Current, Forward	$V_{GS} = 25\text{ V}, V_{DS} = 0\text{ V}$	--	--	100	nA
$I_{GSSR}$	Gate-Body Leakage Current, Reverse	$V_{GS} = -25\text{ V}, V_{DS} = 0\text{ V}$	--	--	-100	nA

### On Characteristics

$V_{GS(th)}$	Gate Threshold Voltage	$V_{DS} = V_{GS}, I_D = 250\ \mu\text{A}$	2.0	--	4.0	V
$R_{DS(on)}$	Static Drain-Source On-Resistance	$V_{GS} = 10\text{ V}, I_D = 9.0\text{ A}$	--	0.155	0.18	$\Omega$
$g_{FS}$	Forward Transconductance	$V_{DS} = 40\text{ V}, I_D = 9.0\text{ A}$ (Note 4)	--	13	--	S

### Dynamic Characteristics

$C_{iss}$	Input Capacitance	$V_{DS} = 25\text{ V}, V_{GS} = 0\text{ V},$ $f = 1.0\text{ MHz}$	--	1130	1470	pF
$C_{oss}$	Output Capacitance		--	225	290	pF
$C_{rss}$	Reverse Transfer Capacitance		--	80	105	pF

### Switching Characteristics

$t_{d(on)}$	Turn-On Delay Time	$V_{DD} = 100\text{ V}, I_D = 18\text{ A},$ $R_G = 25\ \Omega$	--	21	55	ns	
$t_r$	Turn-On Rise Time		--	180	370	ns	
$t_{d(off)}$	Turn-Off Delay Time		(Note 4, 5)	--	110	230	ns
$t_f$	Turn-Off Fall Time		(Note 4, 5)	--	100	210	ns
$Q_g$	Total Gate Charge	$V_{DS} = 160\text{ V}, I_D = 18\text{ A},$ $V_{GS} = 10\text{ V}$	--	45	58	nC	
$Q_{gs}$	Gate-Source Charge		(Note 4, 5)	--	8	--	nC
$Q_{gd}$	Gate-Drain Charge		(Note 4, 5)	--	22	--	nC

### Drain-Source Diode Characteristics and Maximum Ratings

$I_S$	Maximum Continuous Drain-Source Diode Forward Current	--	--	18	A	
$I_{SM}$	Maximum Pulsed Drain-Source Diode Forward Current	--	--	72	A	
$V_{SD}$	Drain-Source Diode Forward Voltage	$V_{GS} = 0\text{ V}, I_S = 18\text{ A}$	--	--	1.5	V
$t_{rr}$	Reverse Recovery Time	$V_{GS} = 0\text{ V}, I_S = 18\text{ A},$ $di_F / dt = 100\text{ A}/\mu\text{s}$	--	160	--	ns
$Q_{rr}$	Reverse Recovery Charge		(Note 4)	--	0.79	--

#### Notes:

1. Repetitive Rating : Pulse width limited by maximum junction temperature
2.  $L = 1.16\text{ mH}, I_{AS} = 18\text{ A}, V_{DD} = 50\text{ V}, R_G = 25\ \Omega$ , Starting  $T_J = 25^\circ\text{C}$
3.  $I_{SD} \leq 18\text{ A}, di/dt \leq 300\ \mu\text{A}/\text{s}, V_{DD} \leq BV_{DSS}$ , Starting  $T_J = 25^\circ\text{C}$
4. Pulse Test : Pulse width  $\leq 300\ \mu\text{s}$ , Duty cycle  $\leq 2\%$
5. Essentially independent of operating temperature

# Typical Characteristics

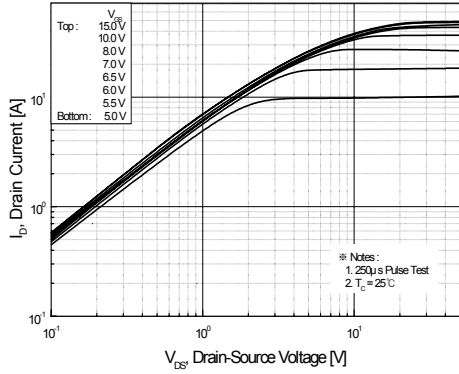


Figure 1. On-Region Characteristics

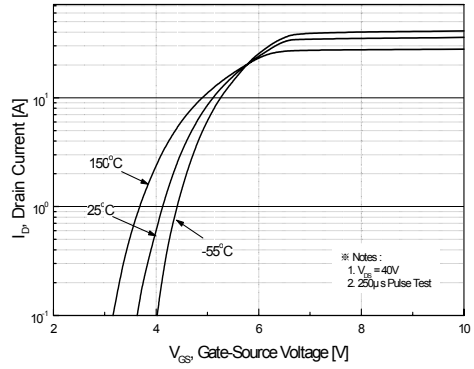


Figure 2. Transfer Characteristics

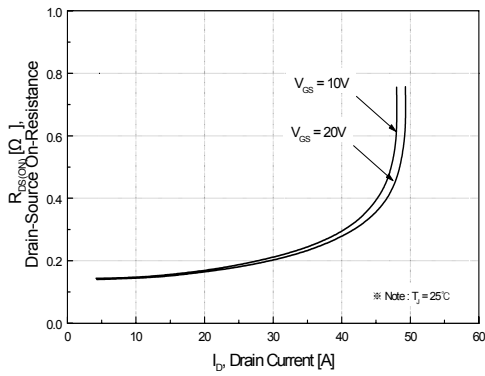


Figure 3. On-Resistance Variation vs Drain Current and Gate Voltage

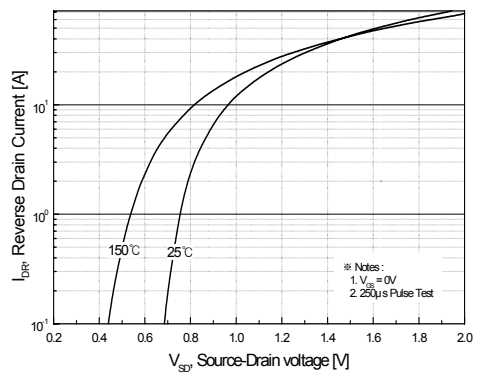


Figure 4. Body Diode Forward Voltage Variation with Source Current and Temperature

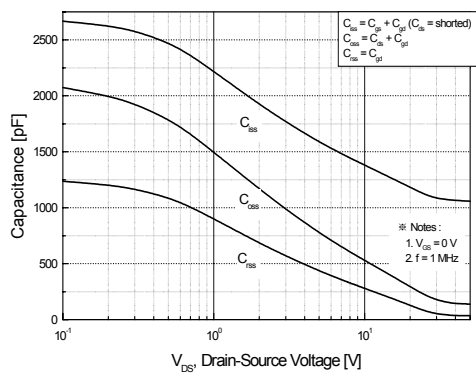


Figure 5. Capacitance Characteristics

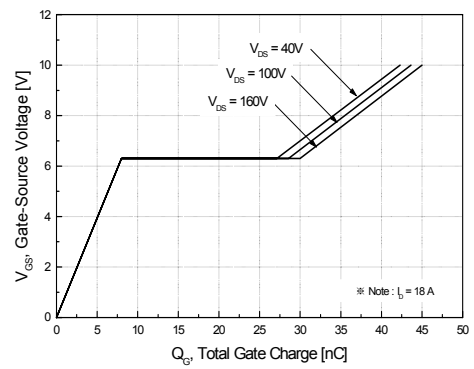
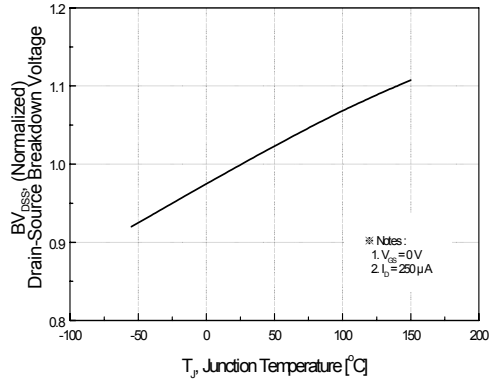
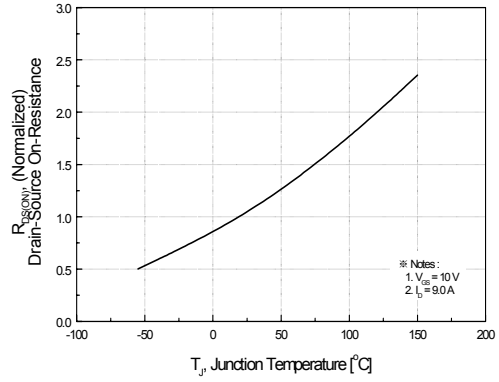


Figure 6. Gate Charge Characteristics

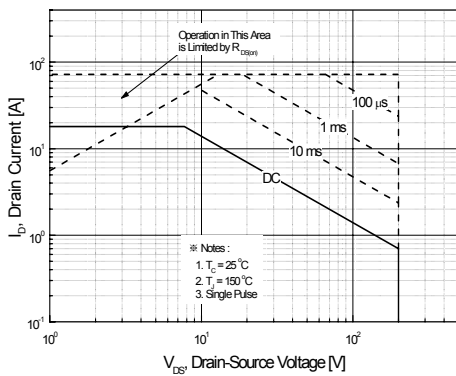
## Typical Characteristics (Continued)



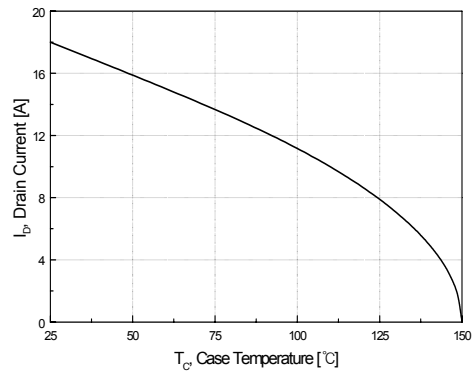
**Figure 7. Breakdown Voltage Variation vs Temperature**



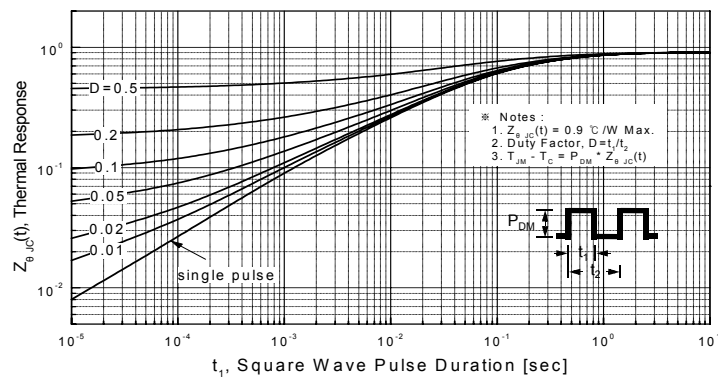
**Figure 8. On-Resistance Variation vs Temperature**



**Figure 9. Maximum Safe Operating Area**

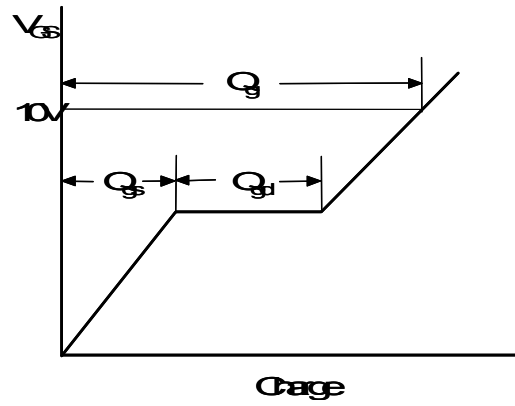
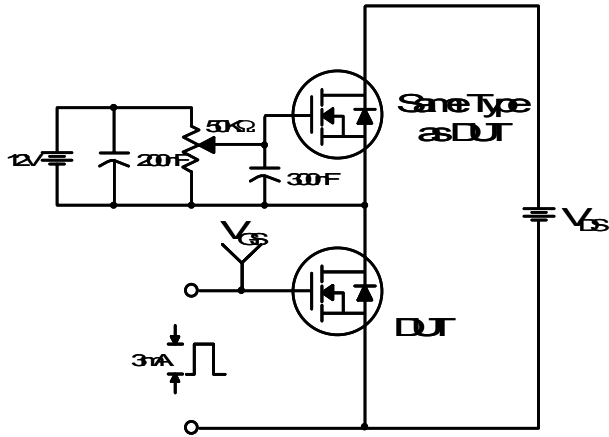


**Figure 10. Maximum Drain Current vs Case Temperature**

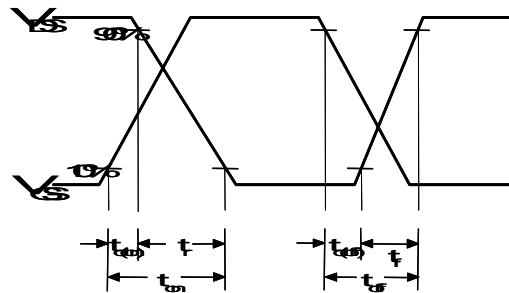
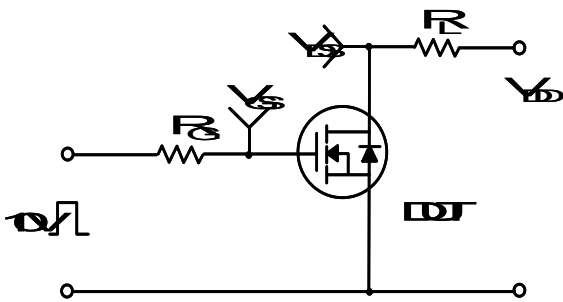


**Figure 11. Transient Thermal Response Curve**

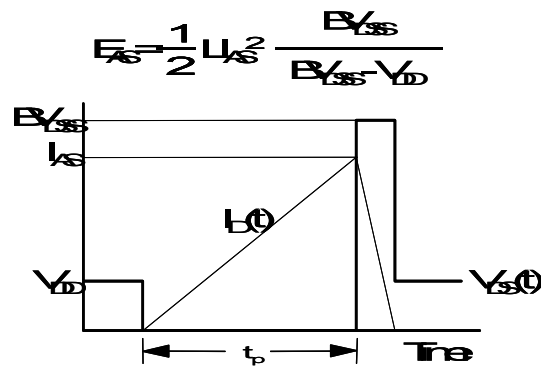
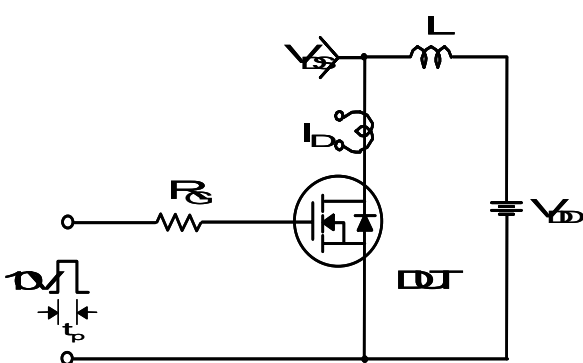
### Gate Charge Test Circuit & Waveform



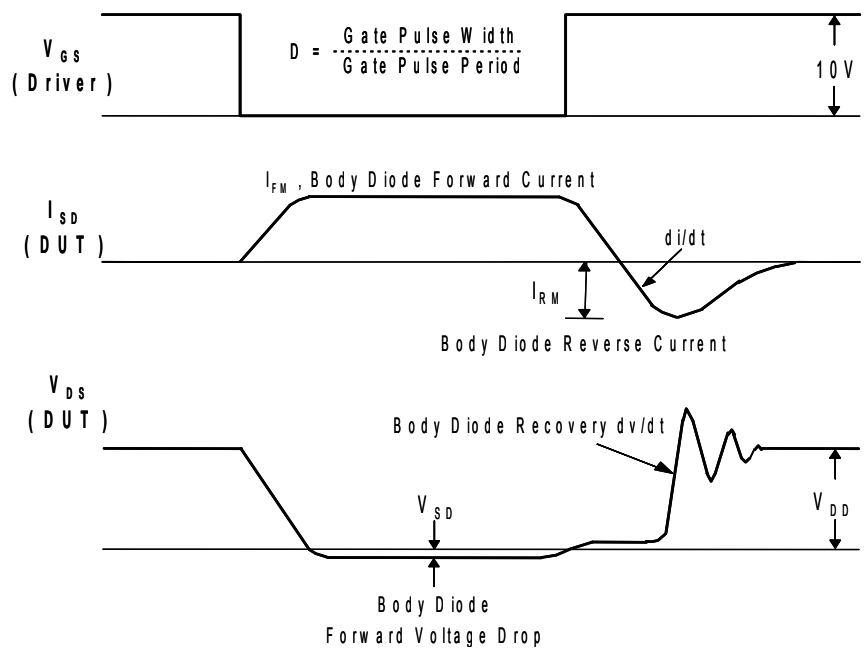
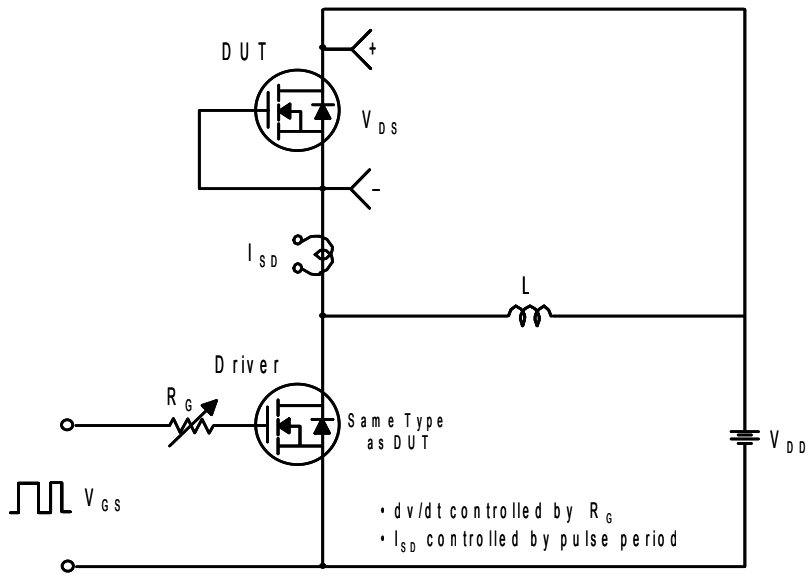
### Resistive Switching Test Circuit & Waveforms



### Unclamped Inductive Switching Test Circuit & Waveforms



### Peak Diode Recovery dv/dt Test Circuit & Waveforms



## TO-220 Package Dimension

Dim.	mm			Inch		
	Min.	Typ.	Max.	Min.	Typ.	Max.
A	9.7		10.1	0.382		0.398
B	6.3		6.7	0.248		0.264
C	9.0		9.47	0.354		0.373
D	12.8		13.3	0.504		0.524
E	1.2		1.4	0.047		0.055
F		1.7			0.067	
G		2.5			0.098	
H	3.0		3.4	0.118		0.134
I	1.25		1.4	0.049		0.055
J	2.4		2.7	0.094		0.106
K	5.0		5.15	0.197		0.203
L	2.2		2.6	0.087		0.102
M	1.25		1.55	0.049		0.061
N	0.45		0.6	0.018		0.024
O	0.6		1.0	0.024		0.039
$\phi$		3.6			0.142	

